

34. Iasen (G 2196), west wall, text on statue niche and intrusive block from G 2196 U, 35-12-40

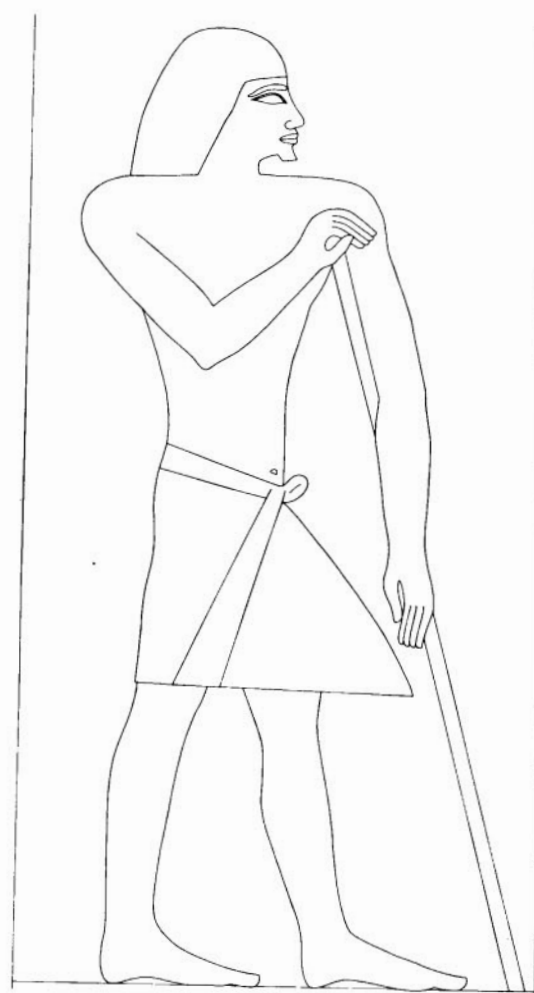

25 CM

35. Iasen (G 2196), west wall, north panel with offering list

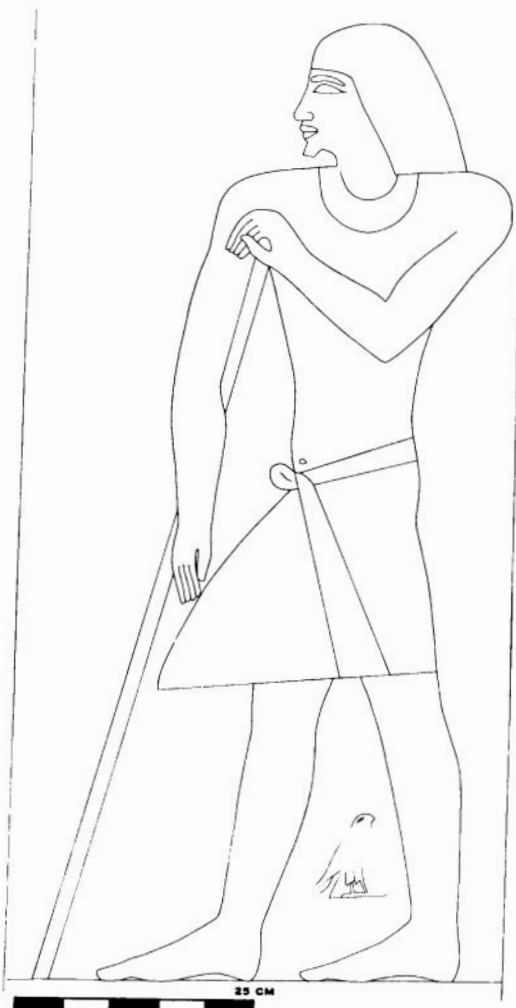
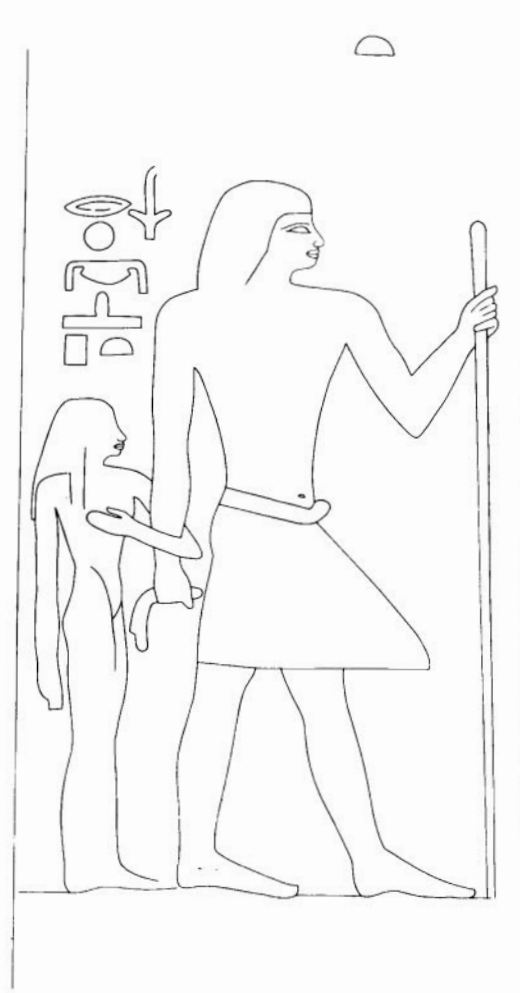

36. Iasen (G 2196), outer jambs (entrance), inner jambs (chapel)

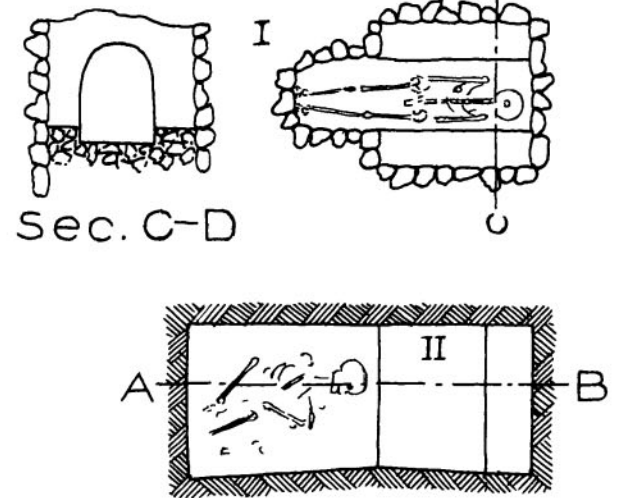
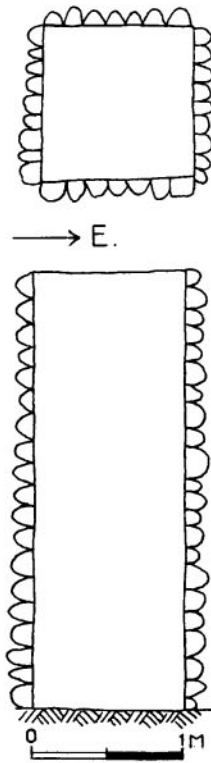
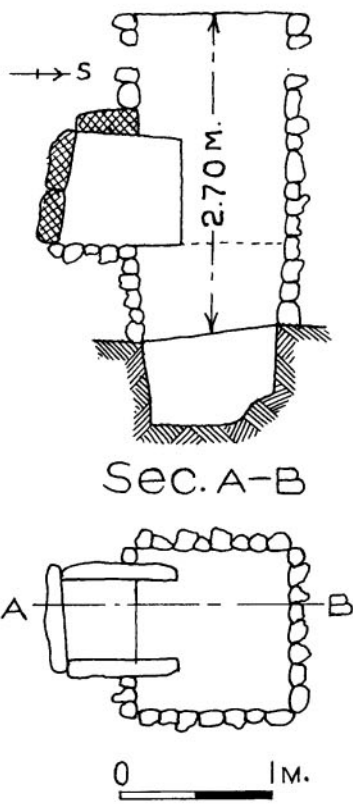
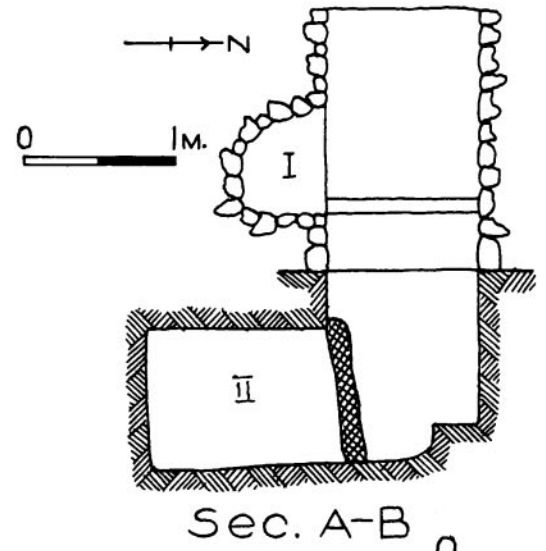
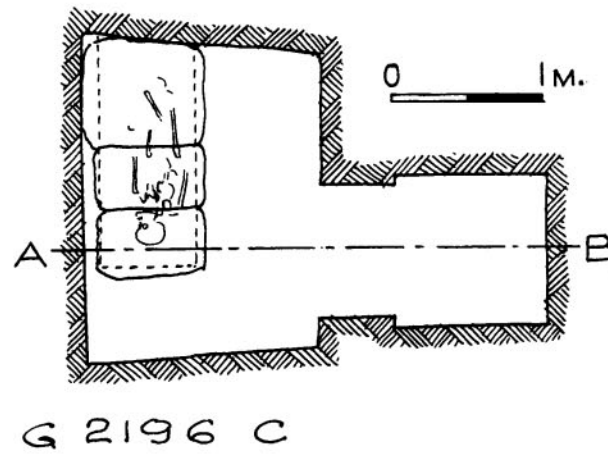
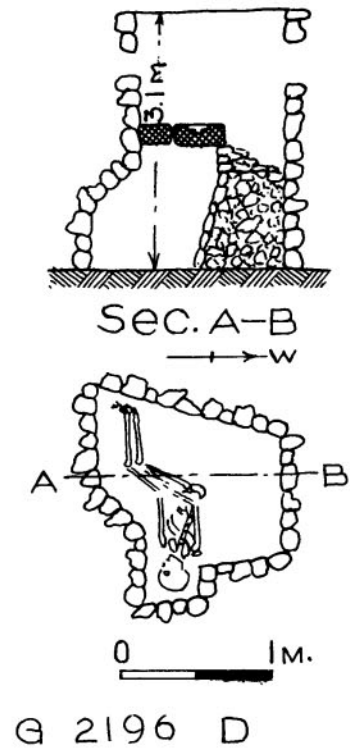
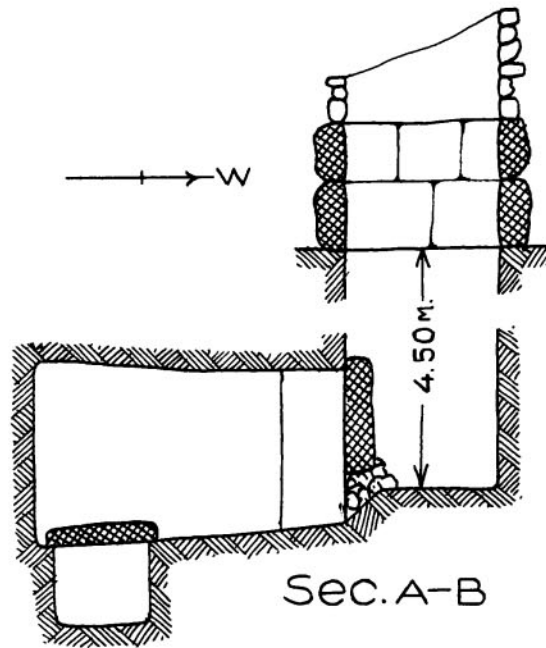
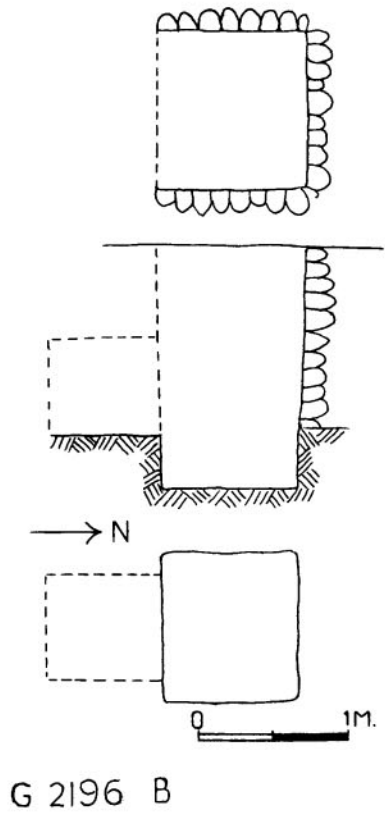

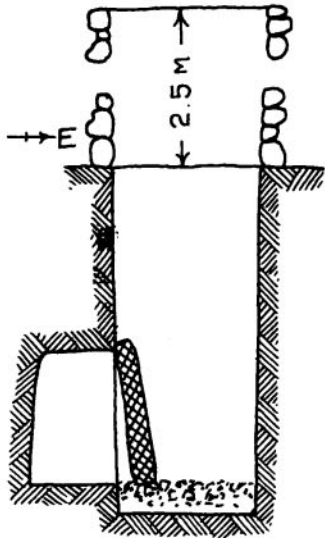

Sec. A-B

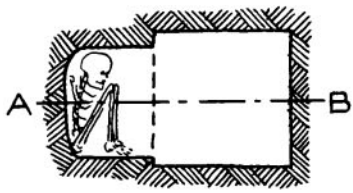

0 1M.

G 2196 I

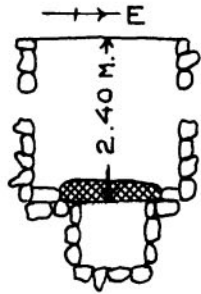

Sec. A-B

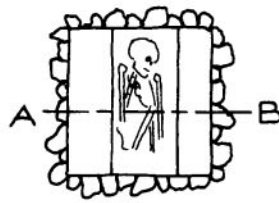

0 1M.

G 2196 HI

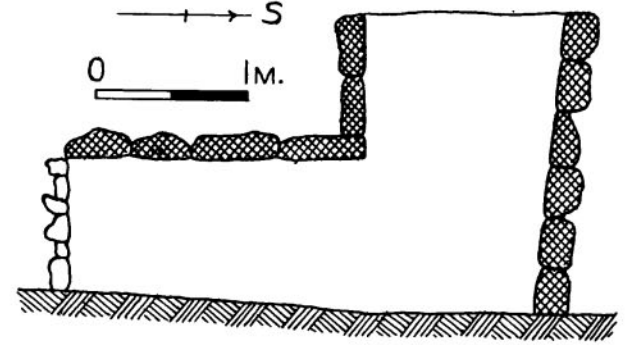

Sec. A-B

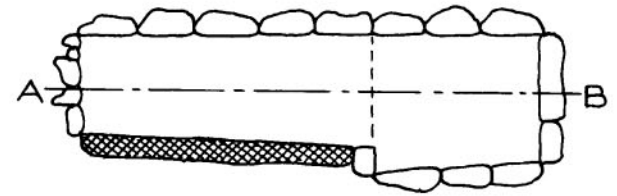

G 2196 U

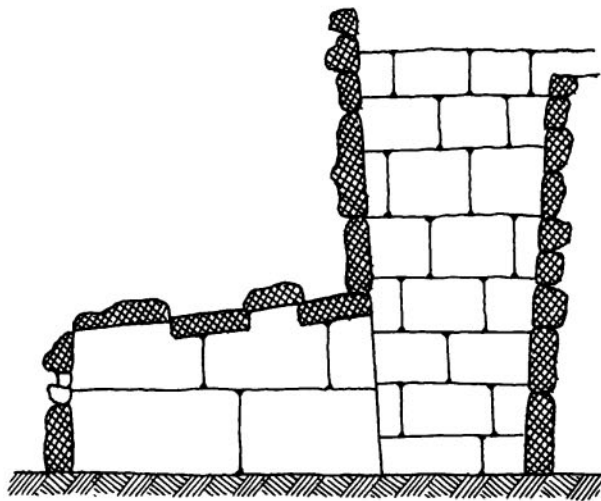

Sec. A-B

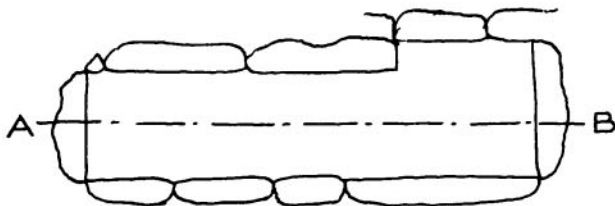

0 1M.

G 2196 Y.

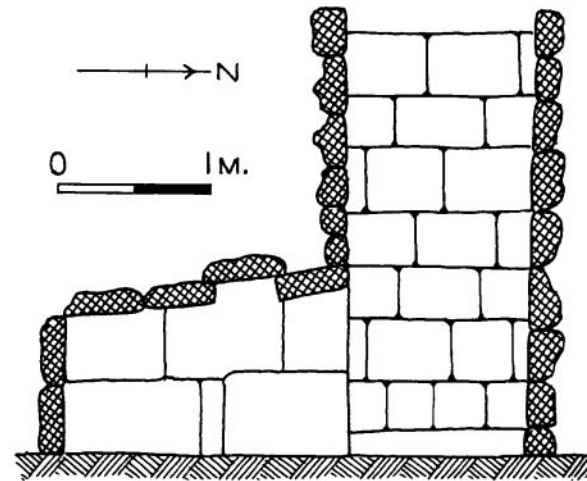

Sec. A-B

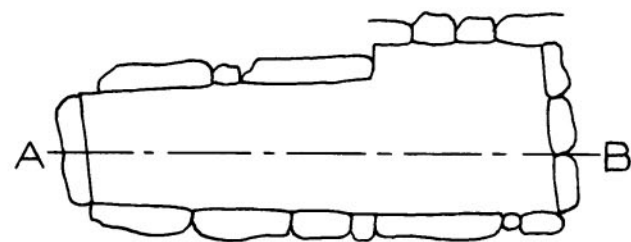

G 2196 Z

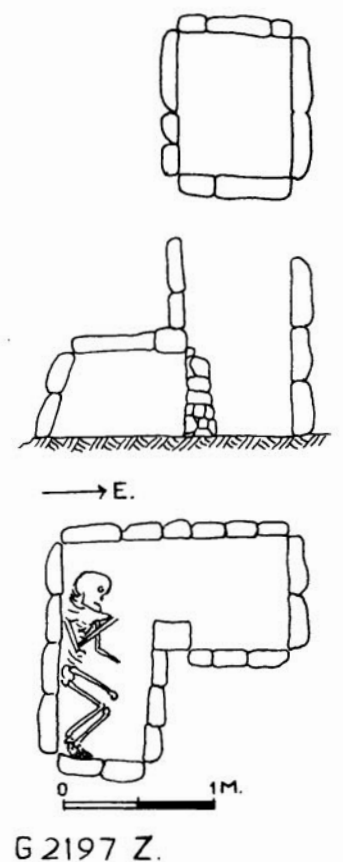
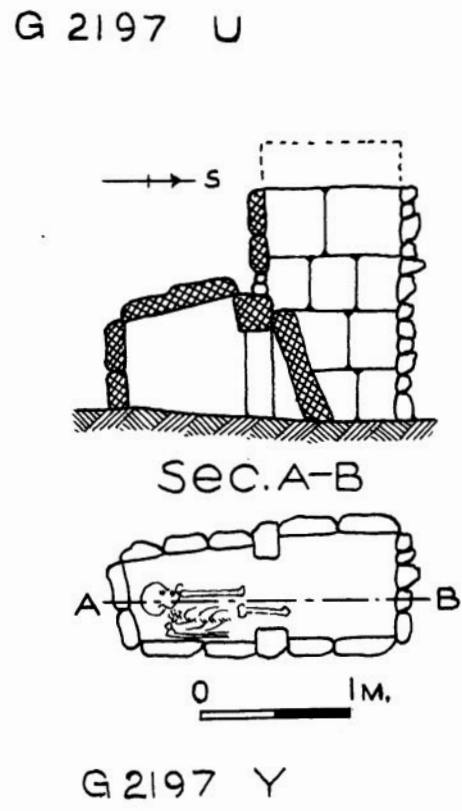
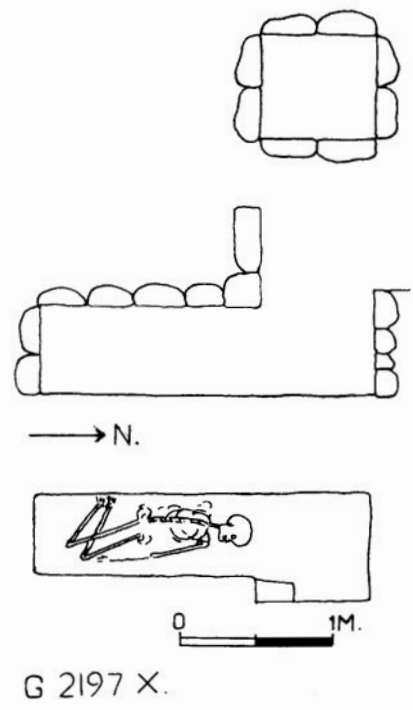
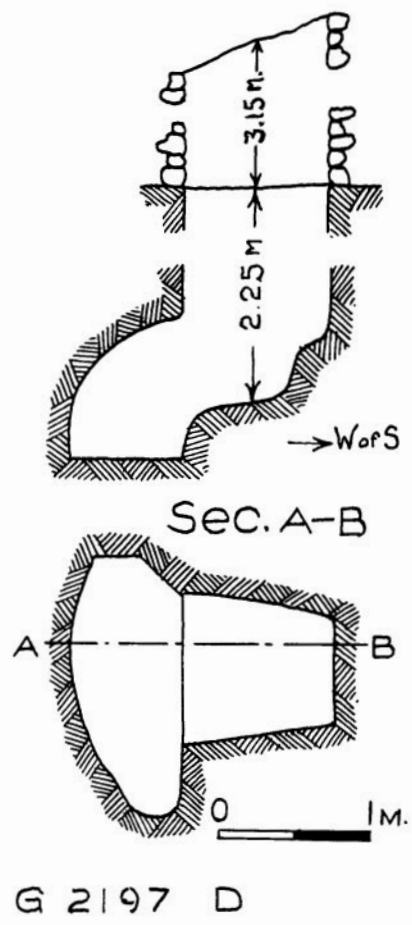
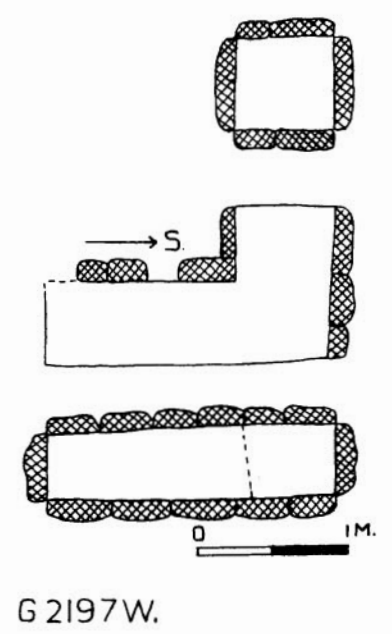
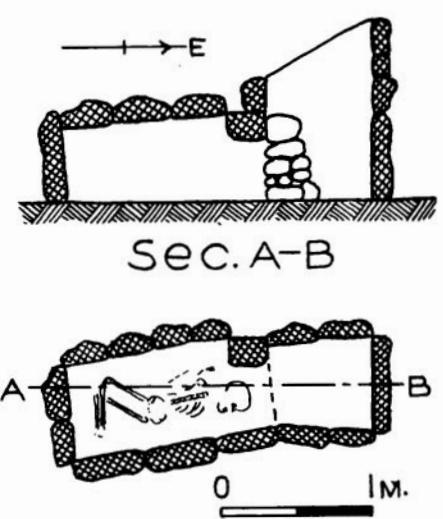
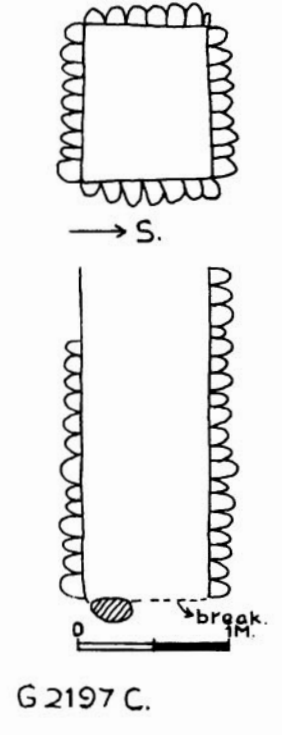
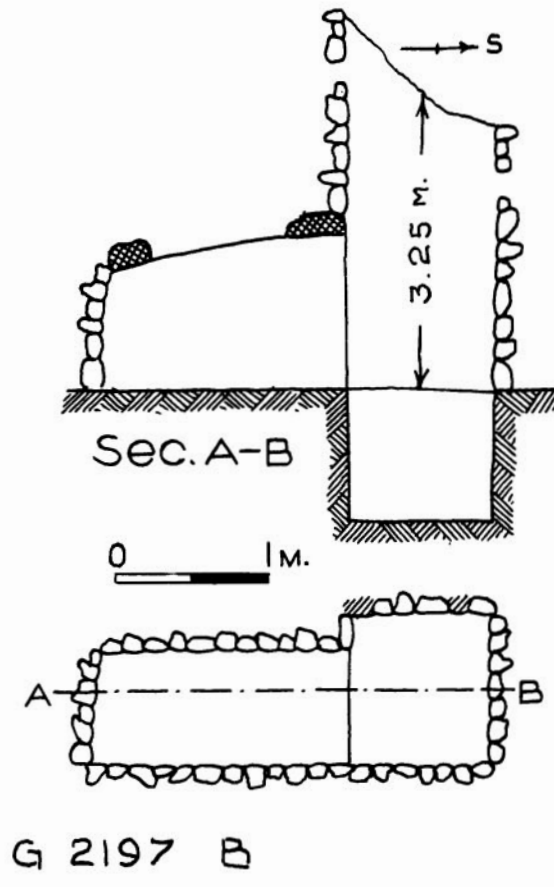
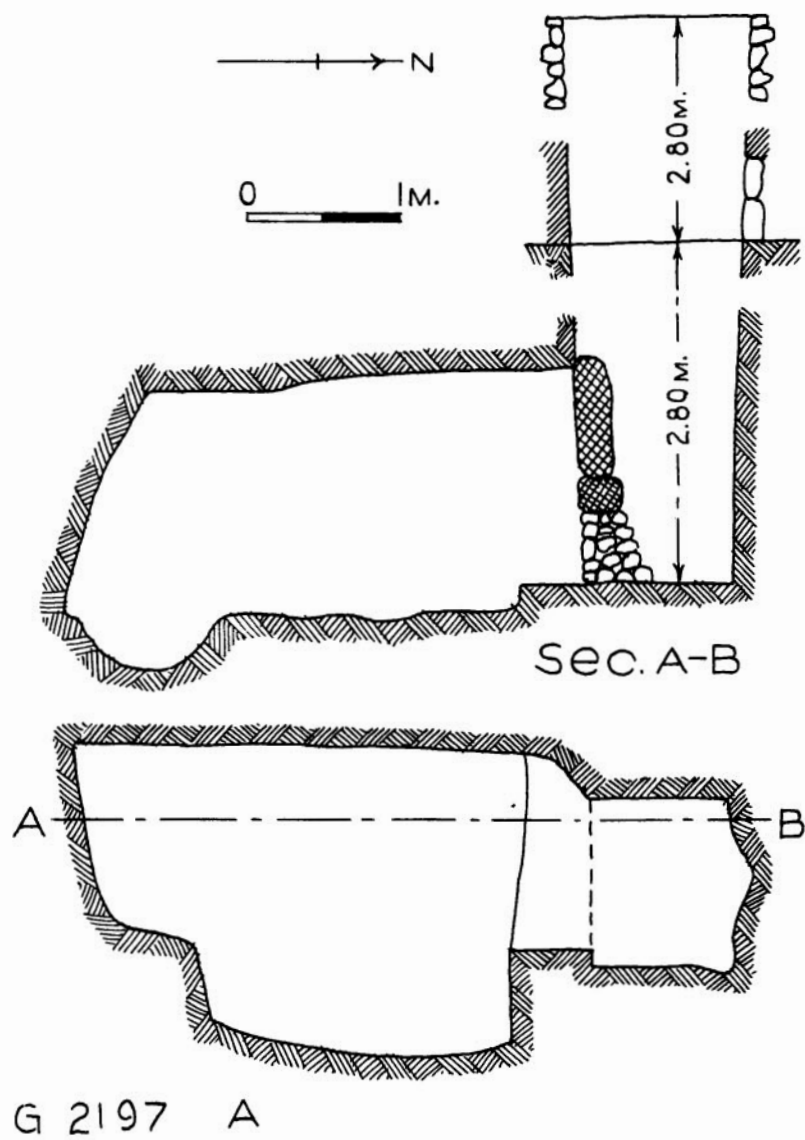

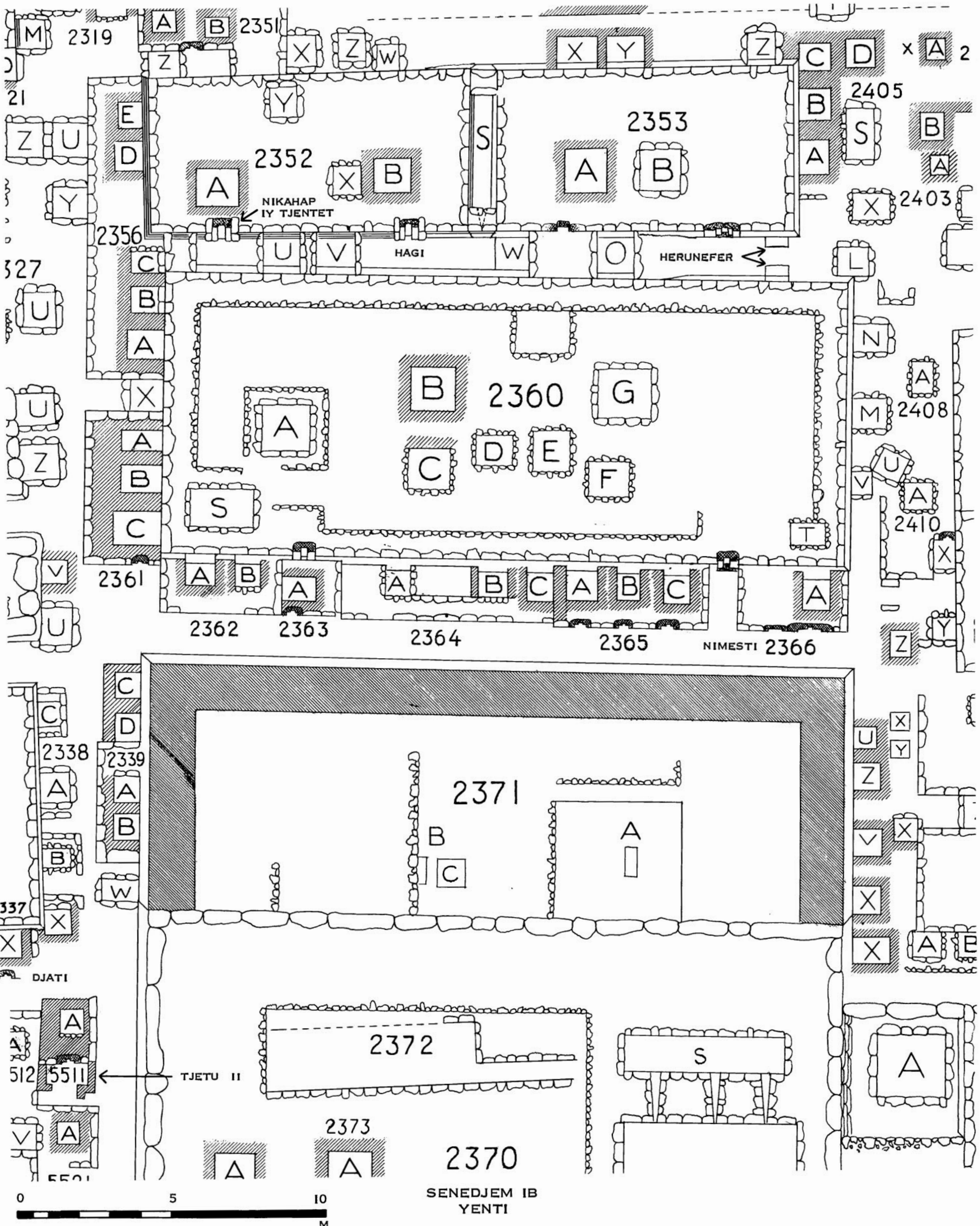

40. Map of part of cemetery en echelon with mastabas described

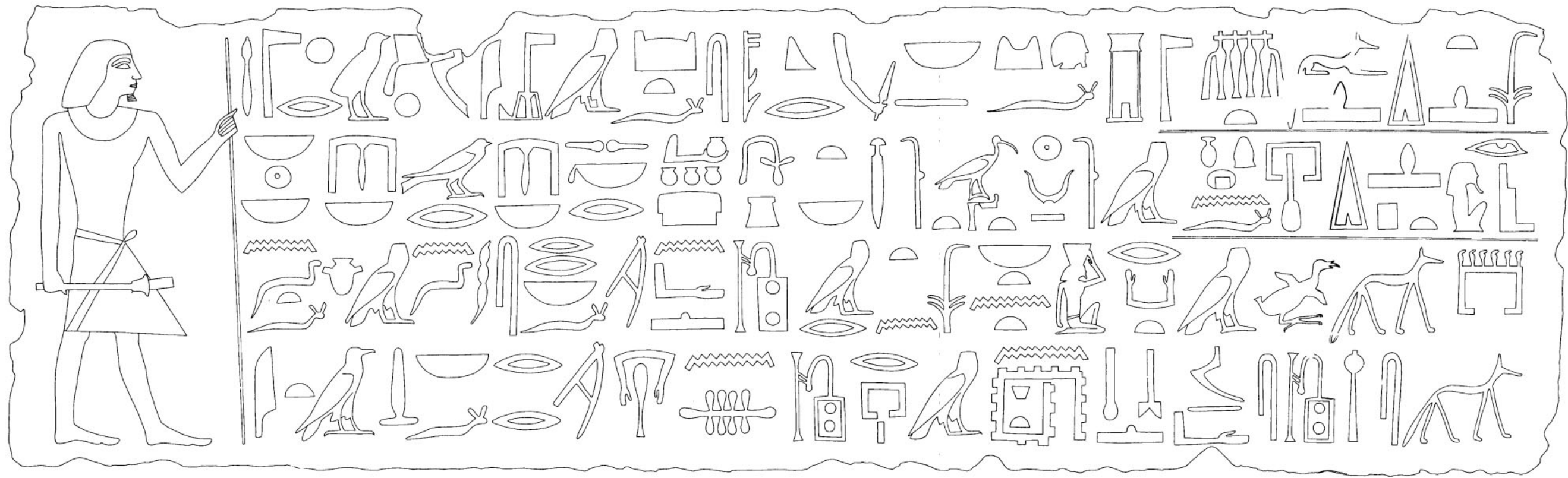

25 CM



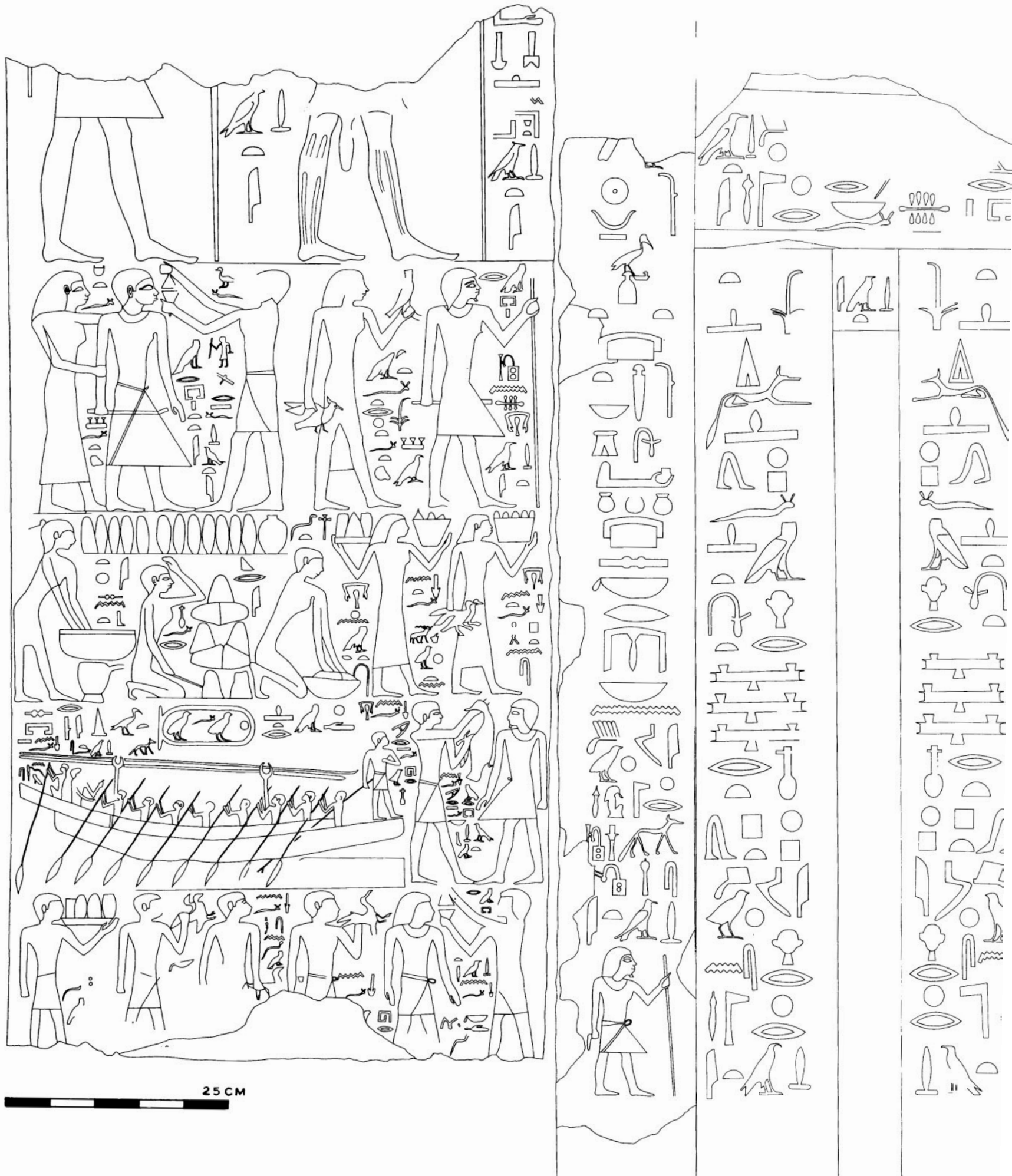

41. Djaty (G 2337 X), inscribed elements

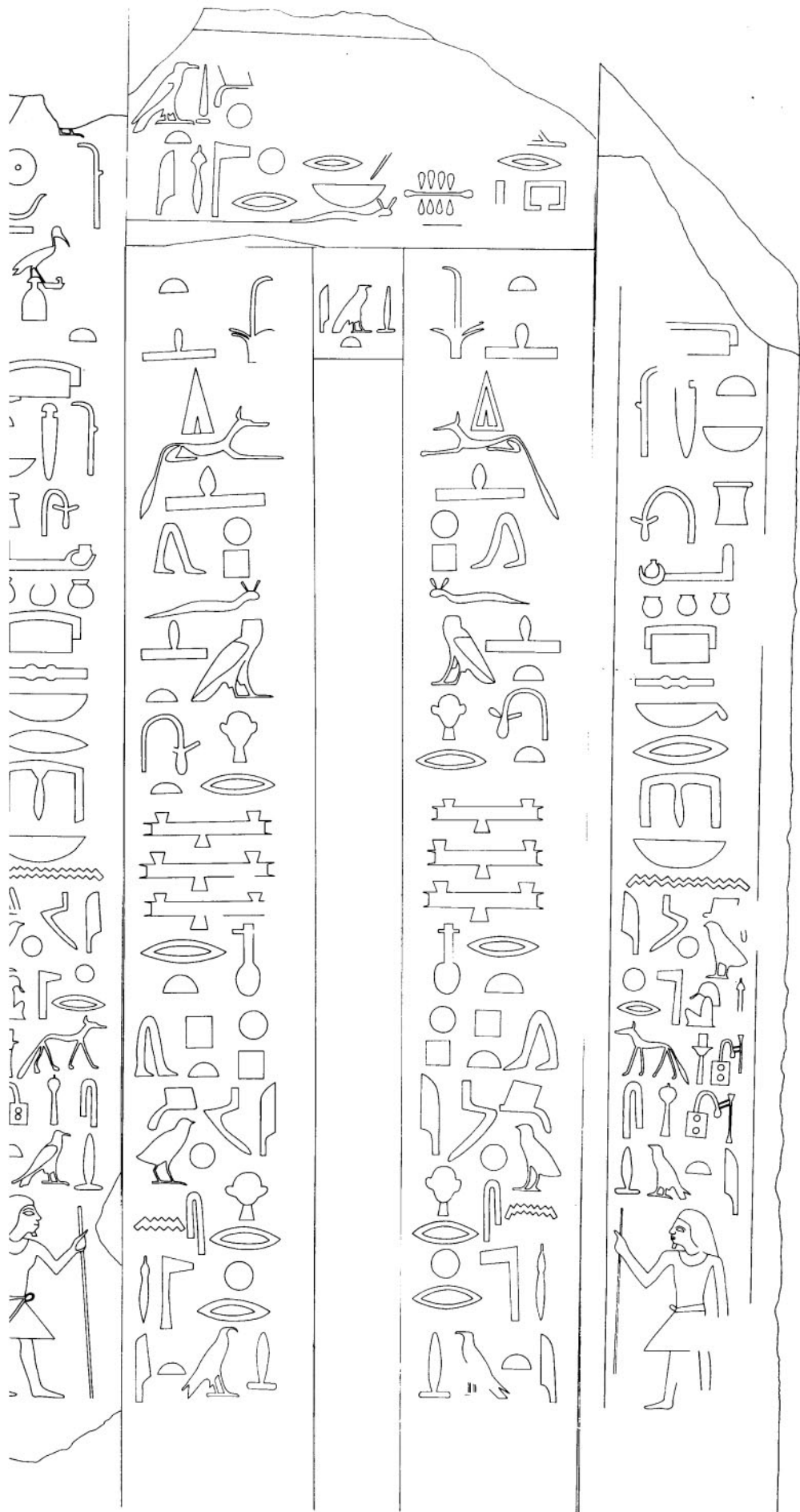

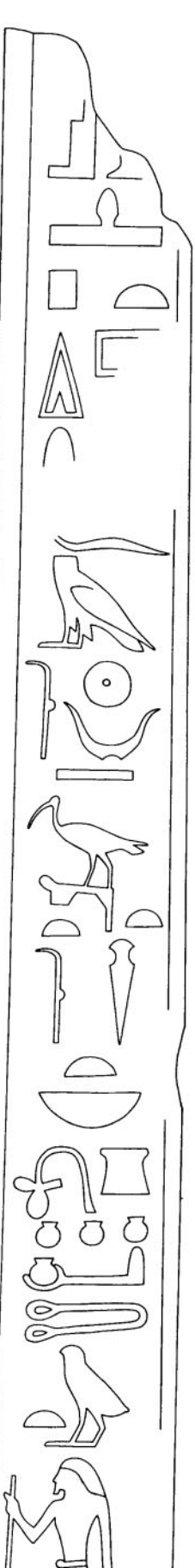
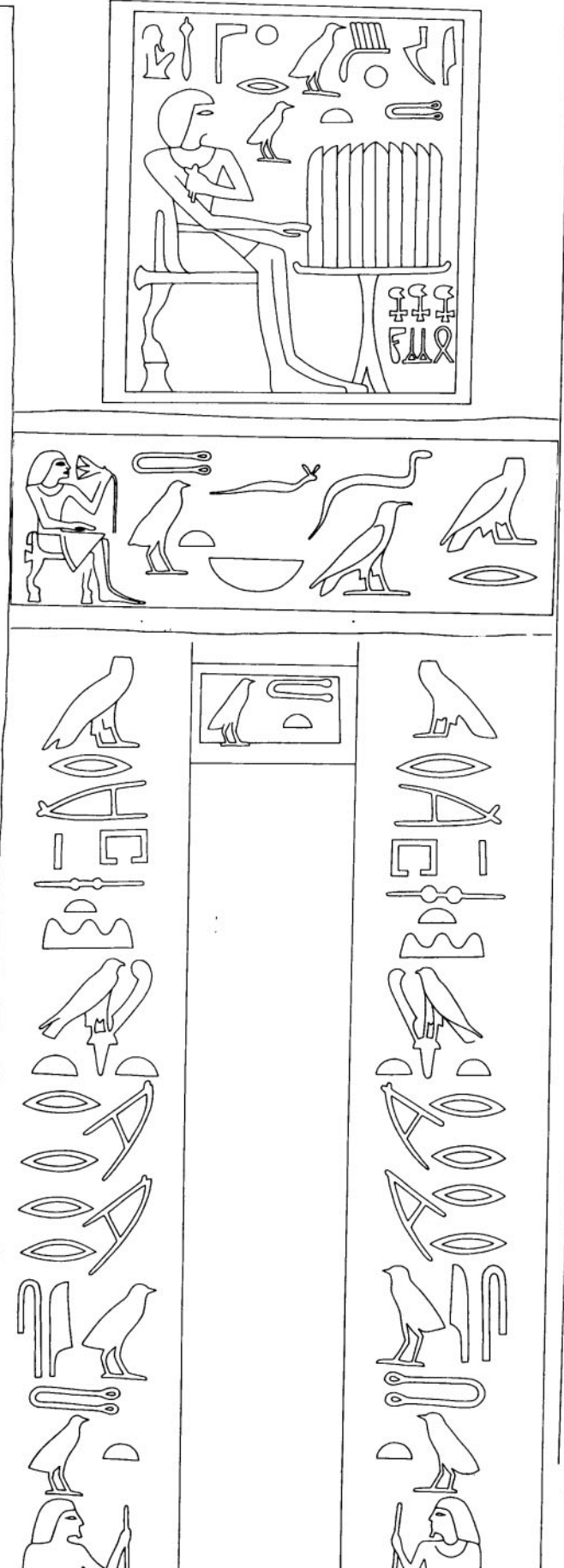
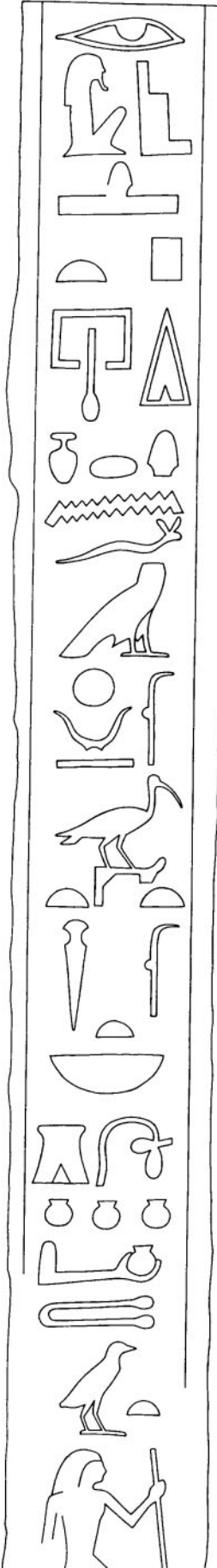

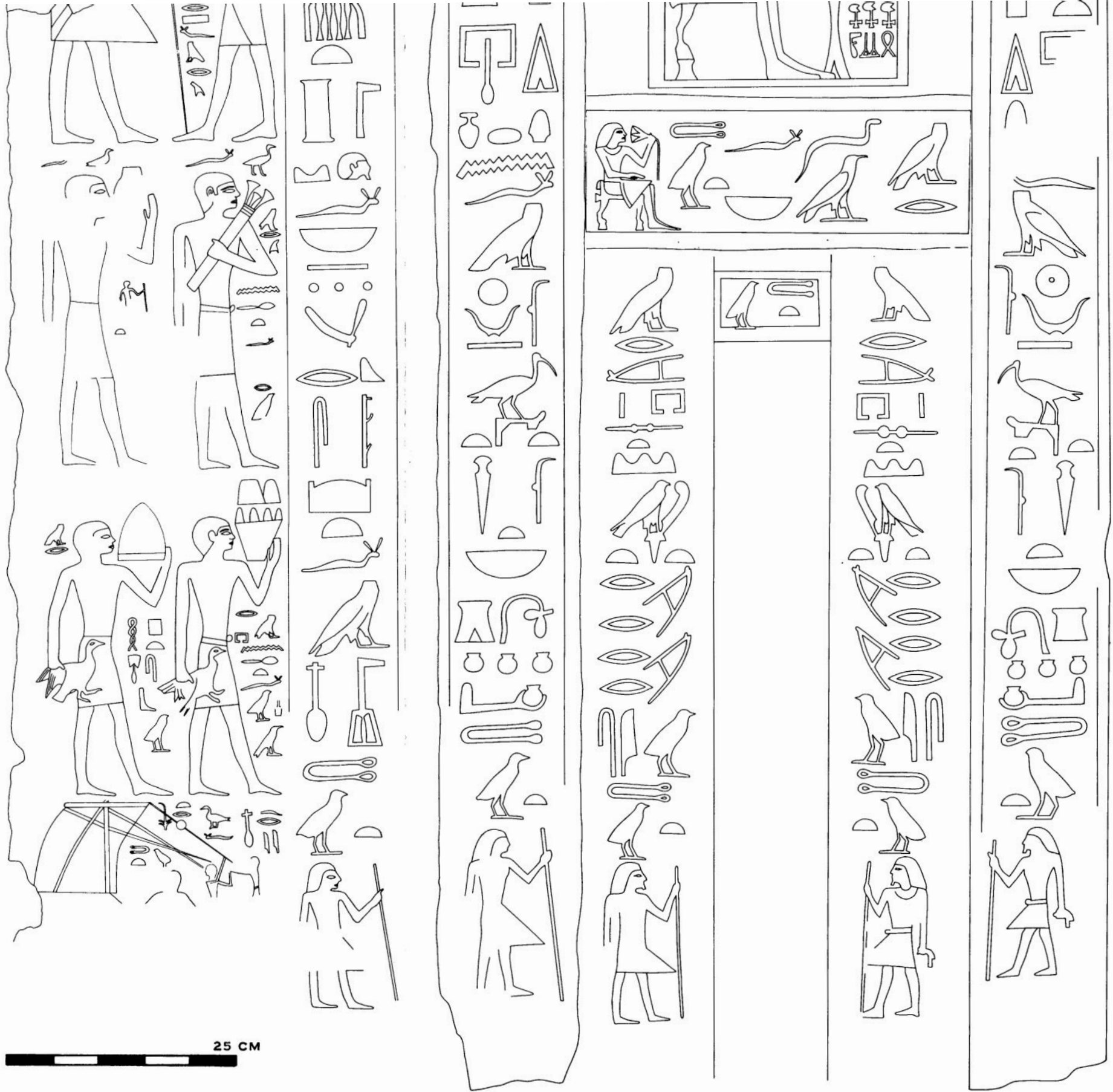

42. Tjetu II (G 2343/5511), inscribed elements of false door

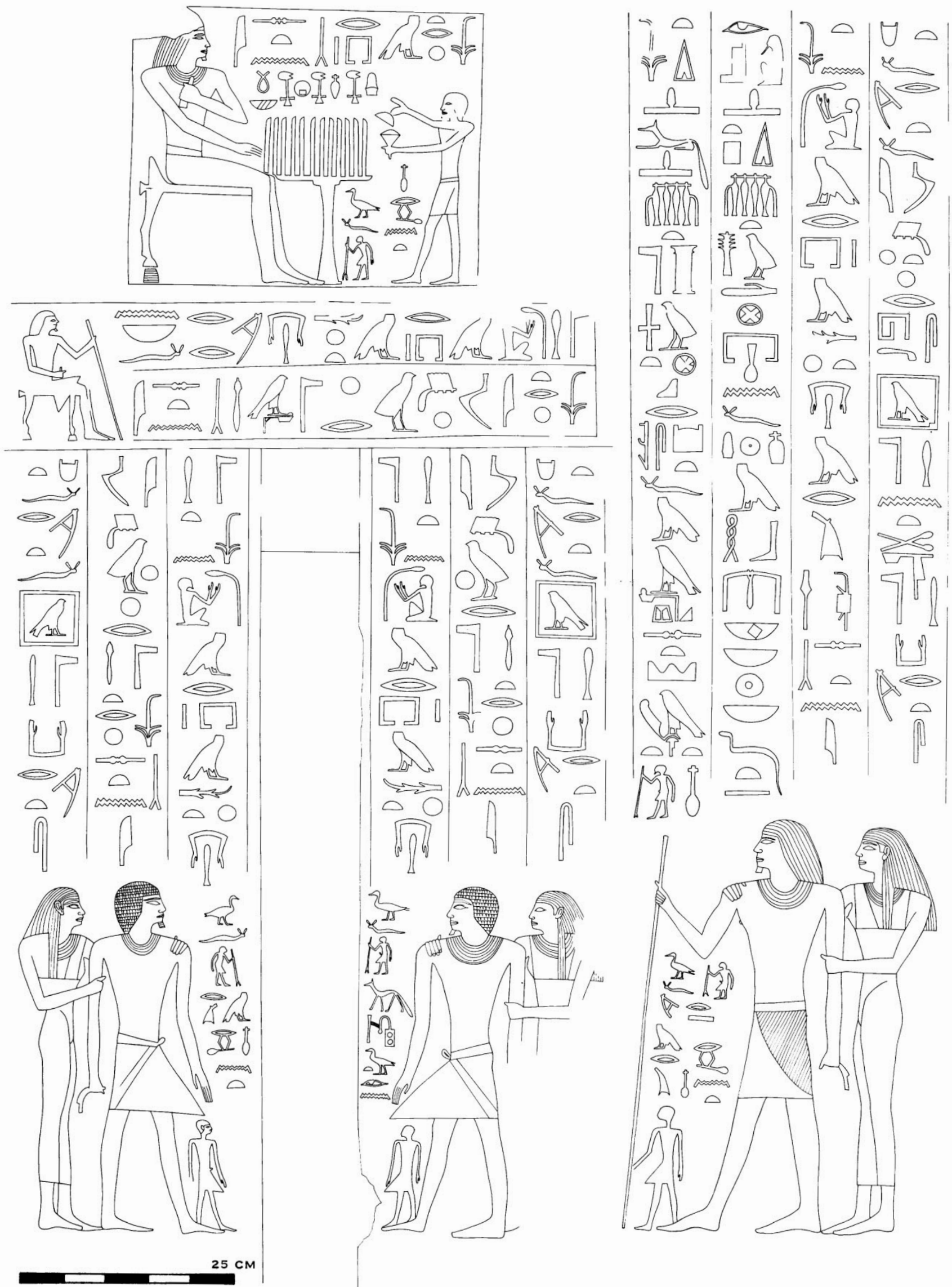

43. Nimesti (G 2366), inscribed elements of false door

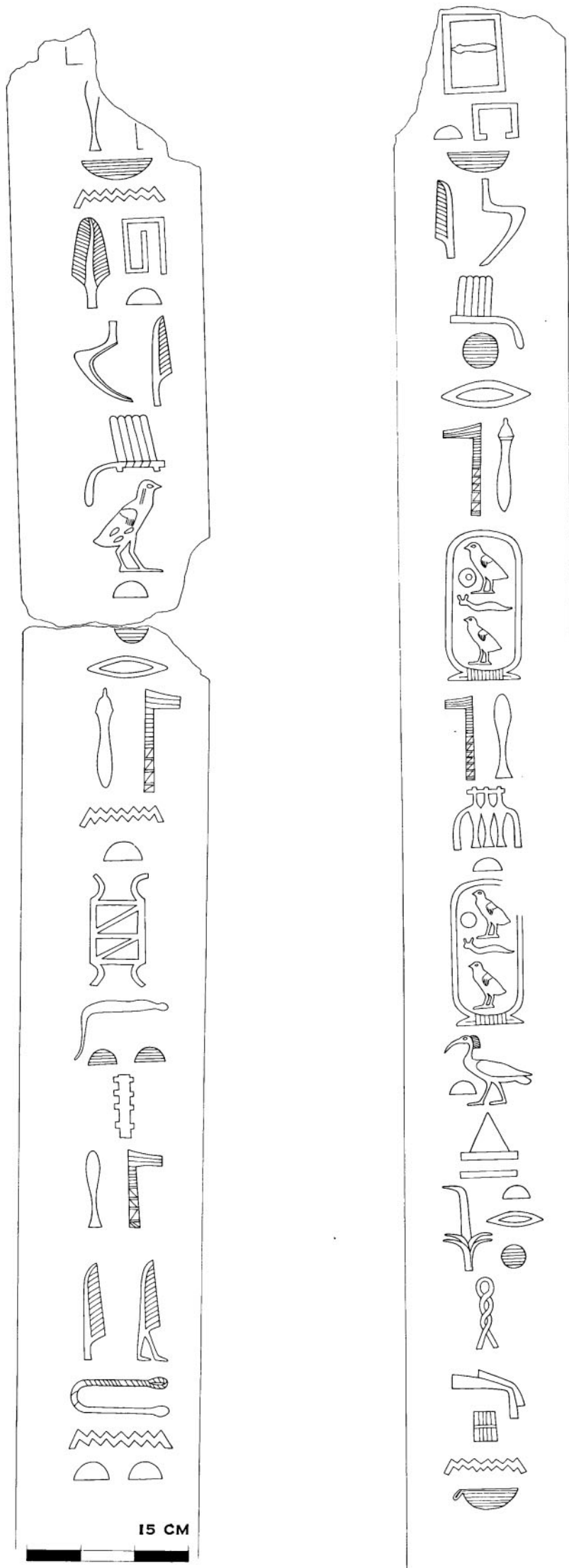

44. Iy-tjentet and Nykahap (G 2352), south false door, inscribed elements

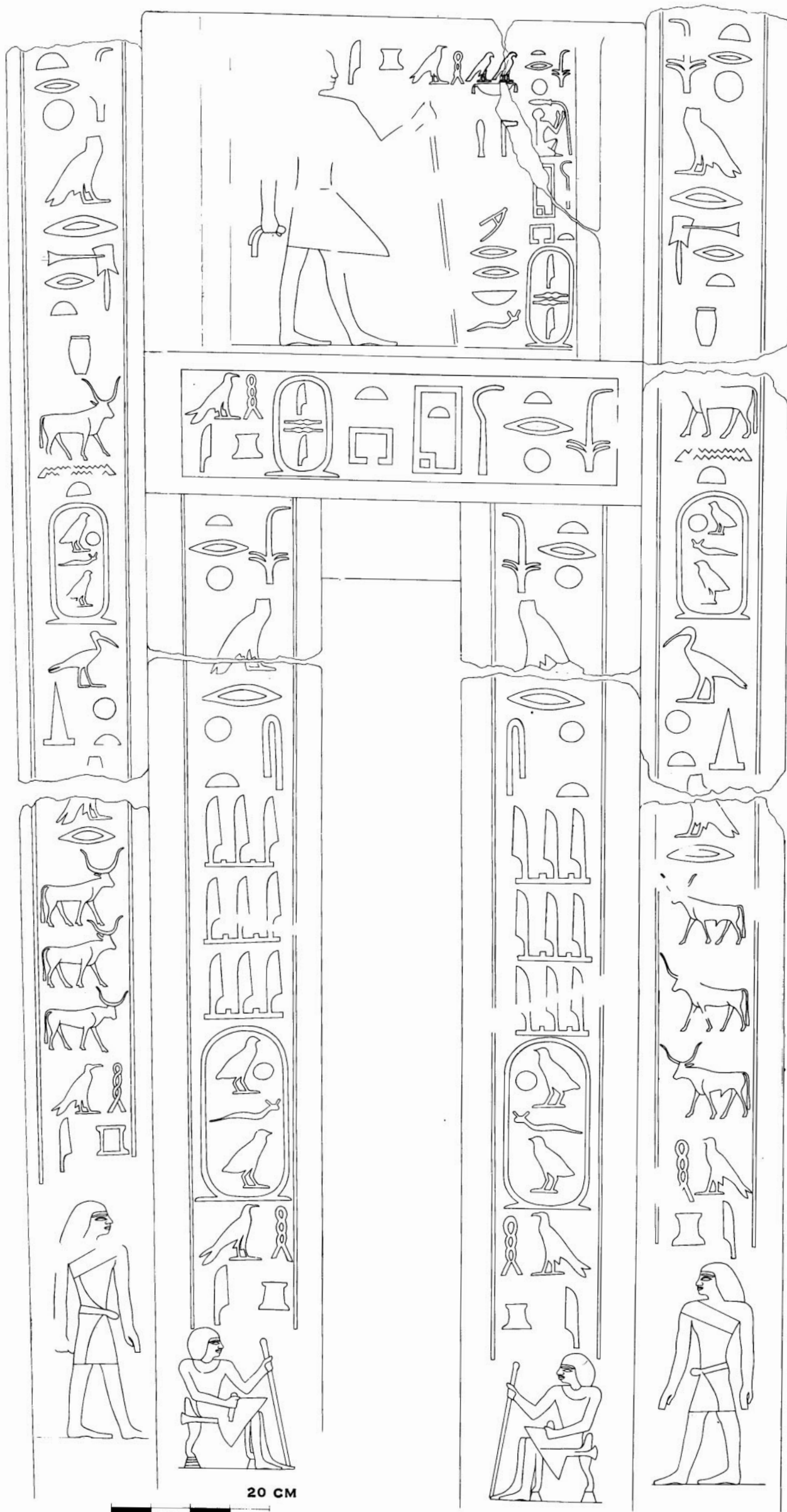

45. Hagya (G 2352), north false door

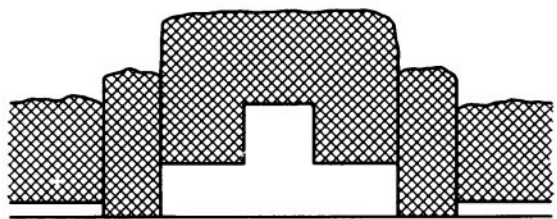
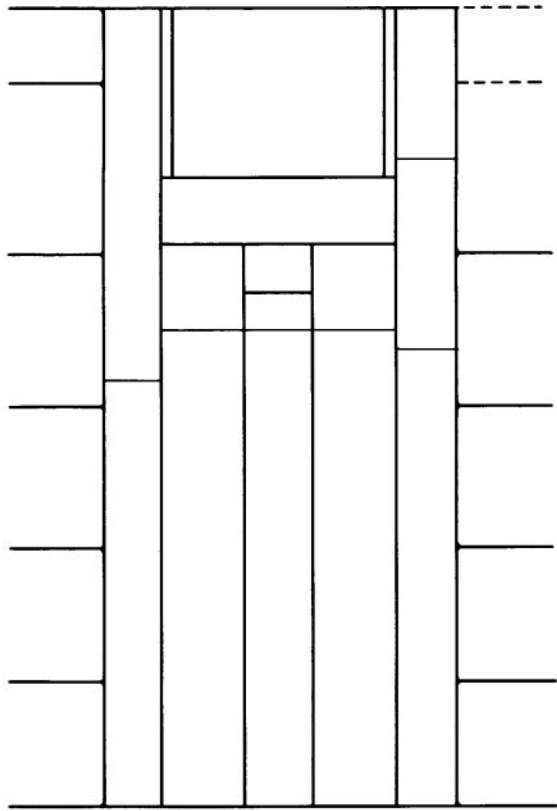

0 1m.

G 2352

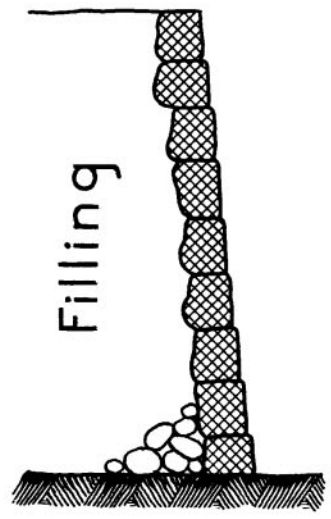

0 1 2m.

Casing type ZU
G 2352

46. Hagy (G 2352), north false door and section of mastaba

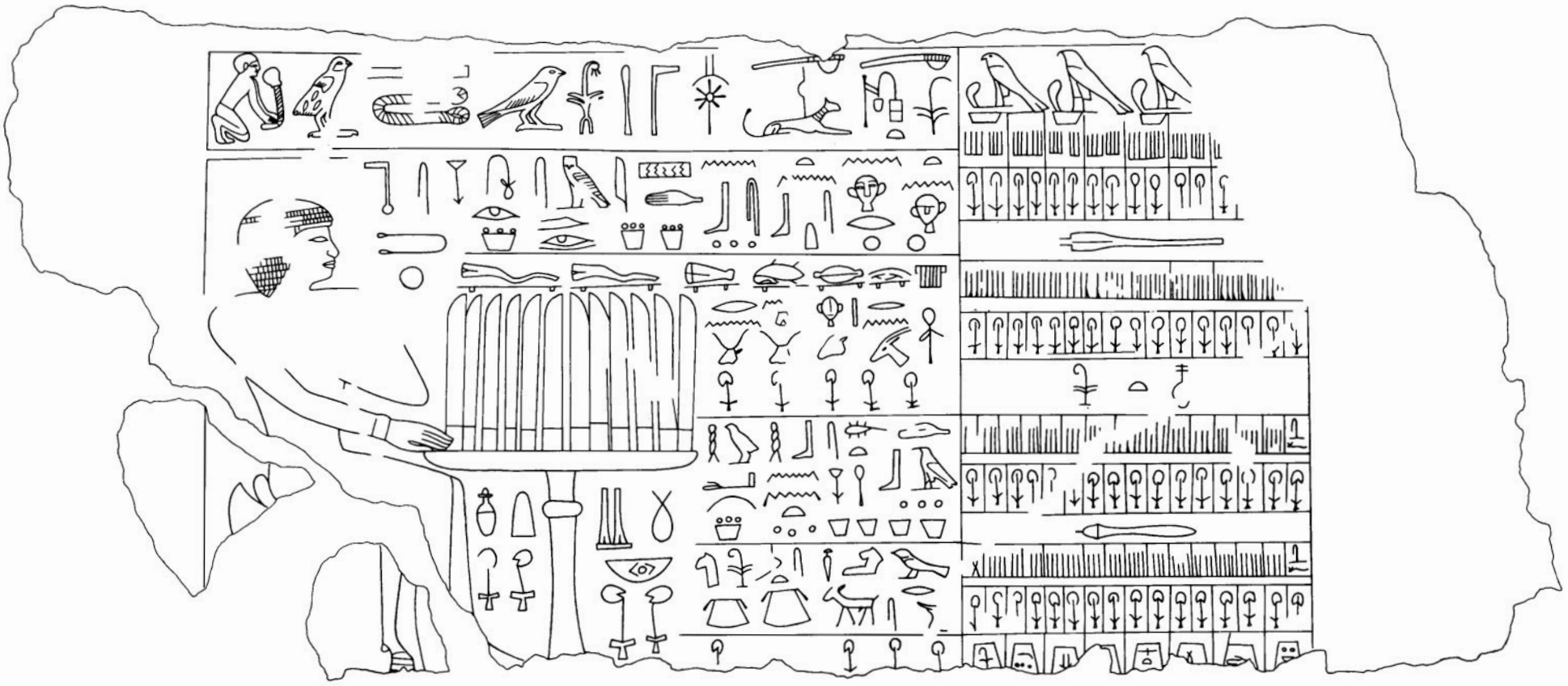

10 CM



47. G 2352 B, filling of shaft, slab stela of Setju, MFA acc. no. 13.4341

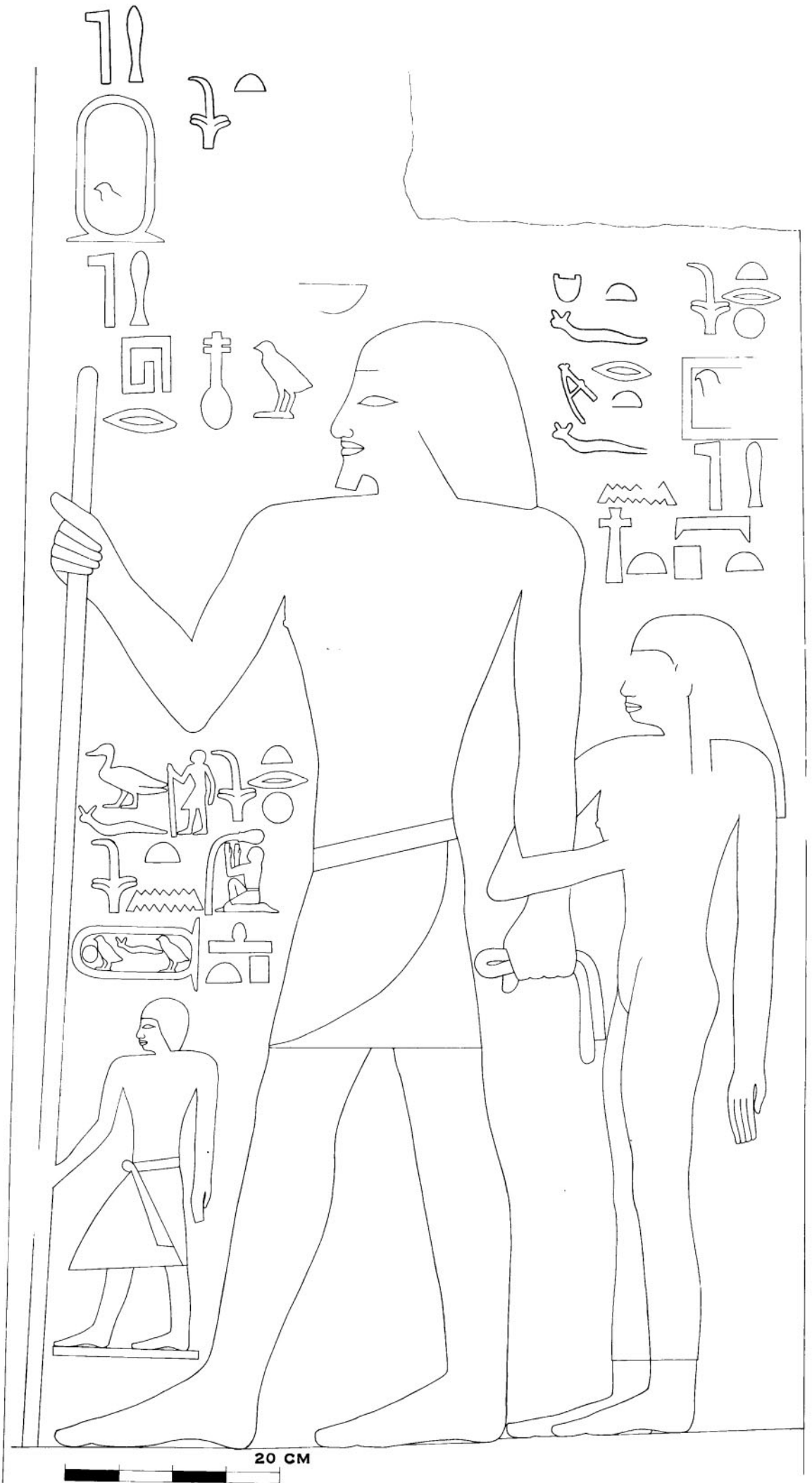

48. Herunefer (G 2353), east entrance jamb

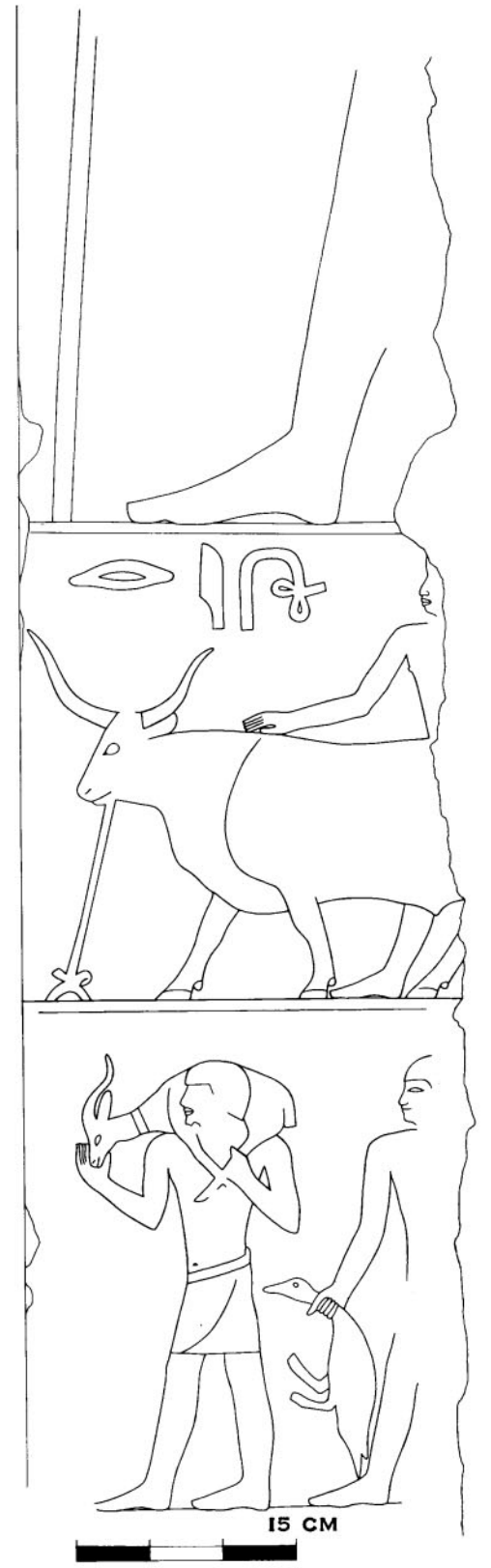
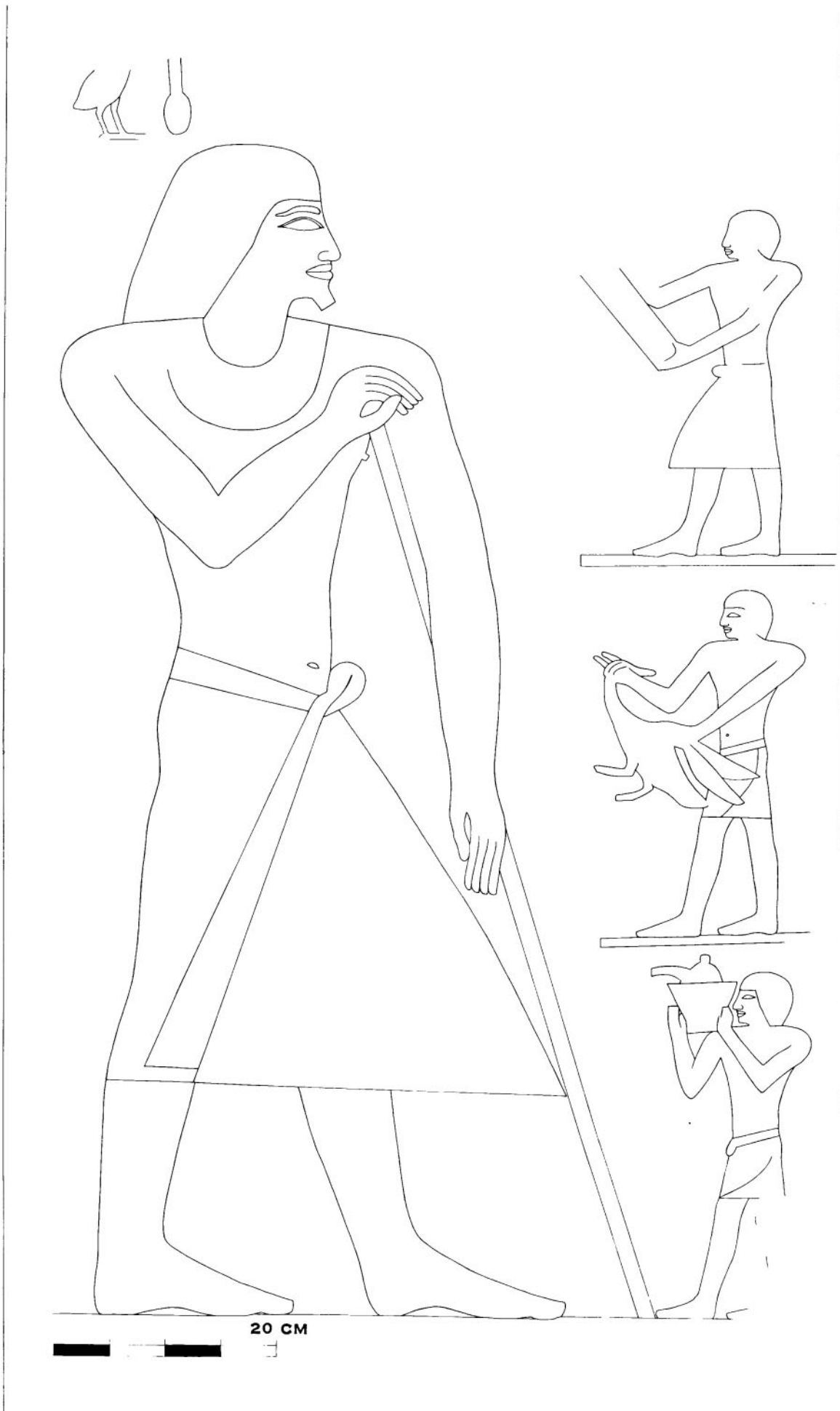

49. Herunefer (G 2353), west entrance jamb

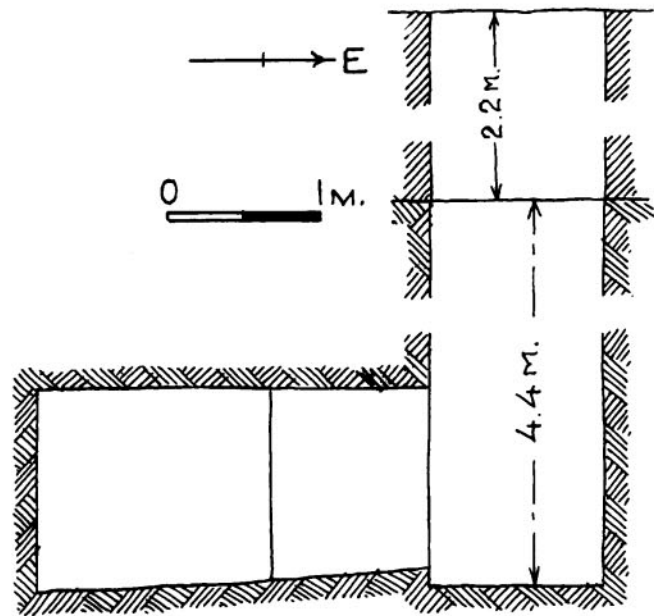

Sec. A-B

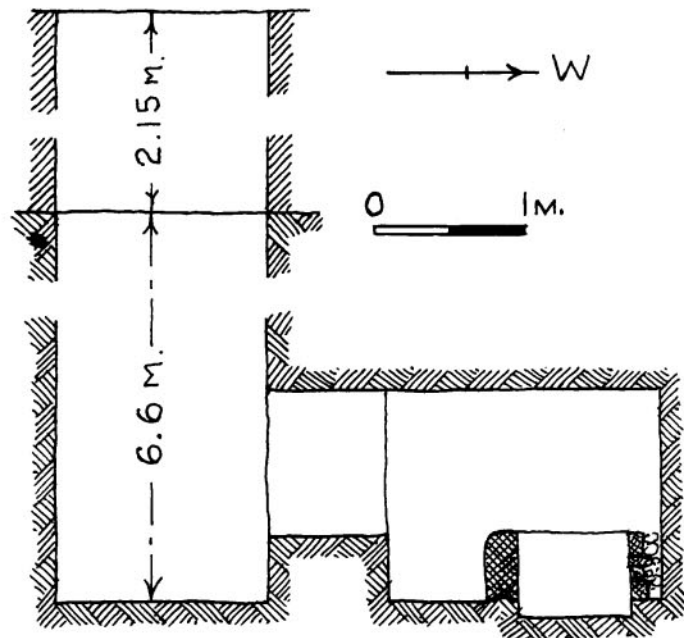

Sec. A-B

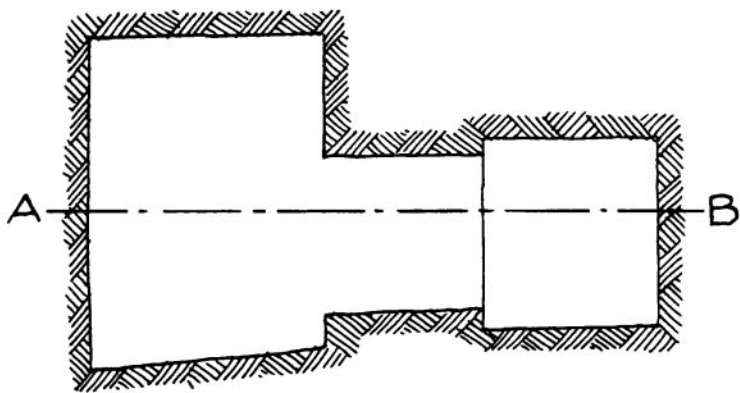

G 2352 A

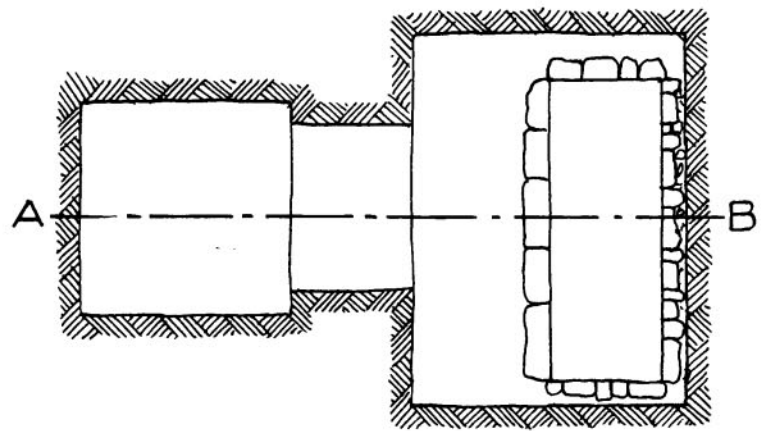

G 2352 B

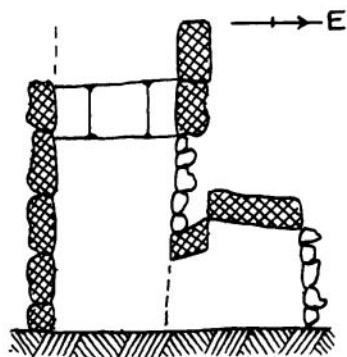

Sec. A-B

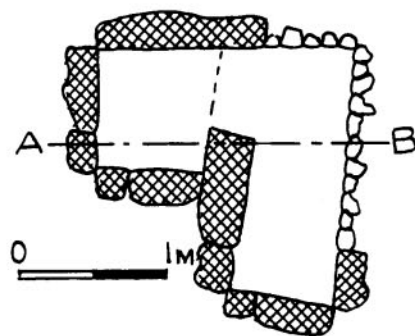

G 2352 Z

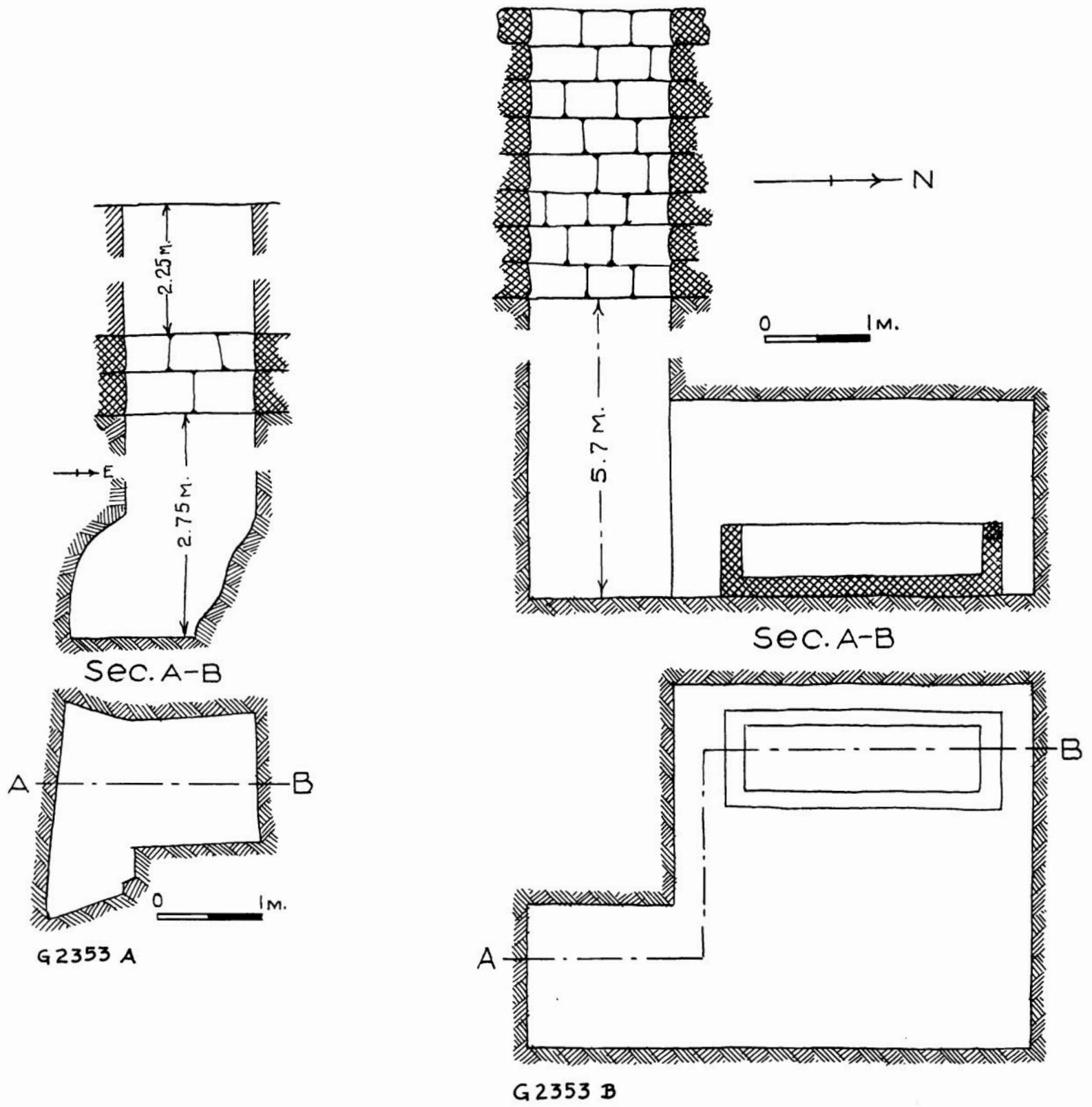

51. G 2353, plans and sections, burials G 2353 A, B



52. G 2353 Y, intrusive stela of Weser