

38. G 6020: Second chamber, west wall

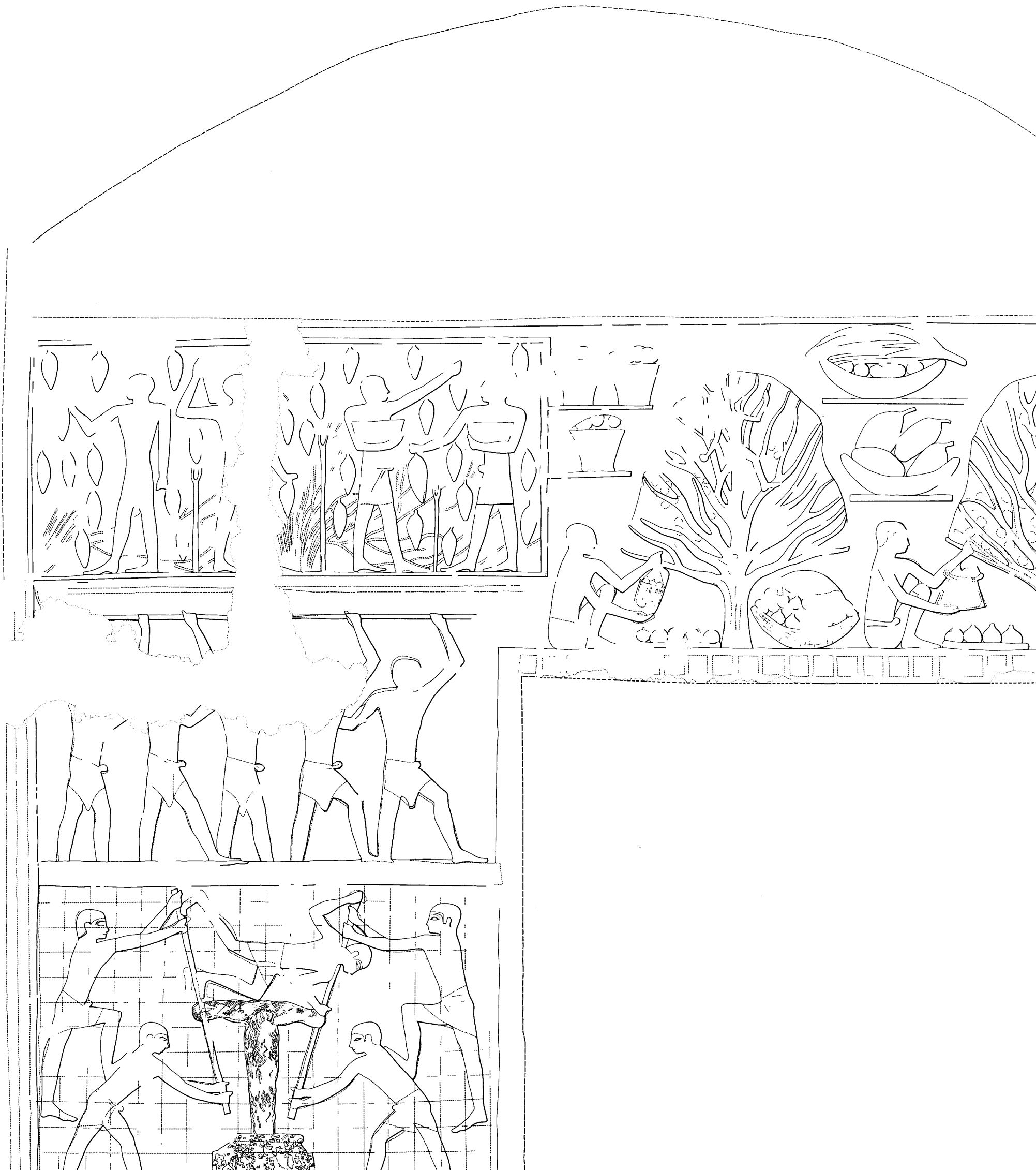

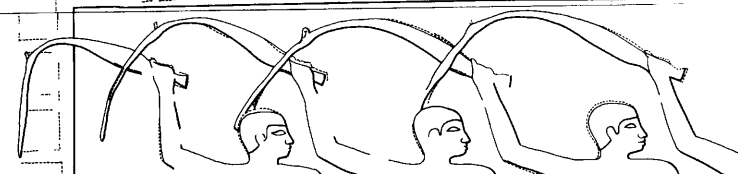

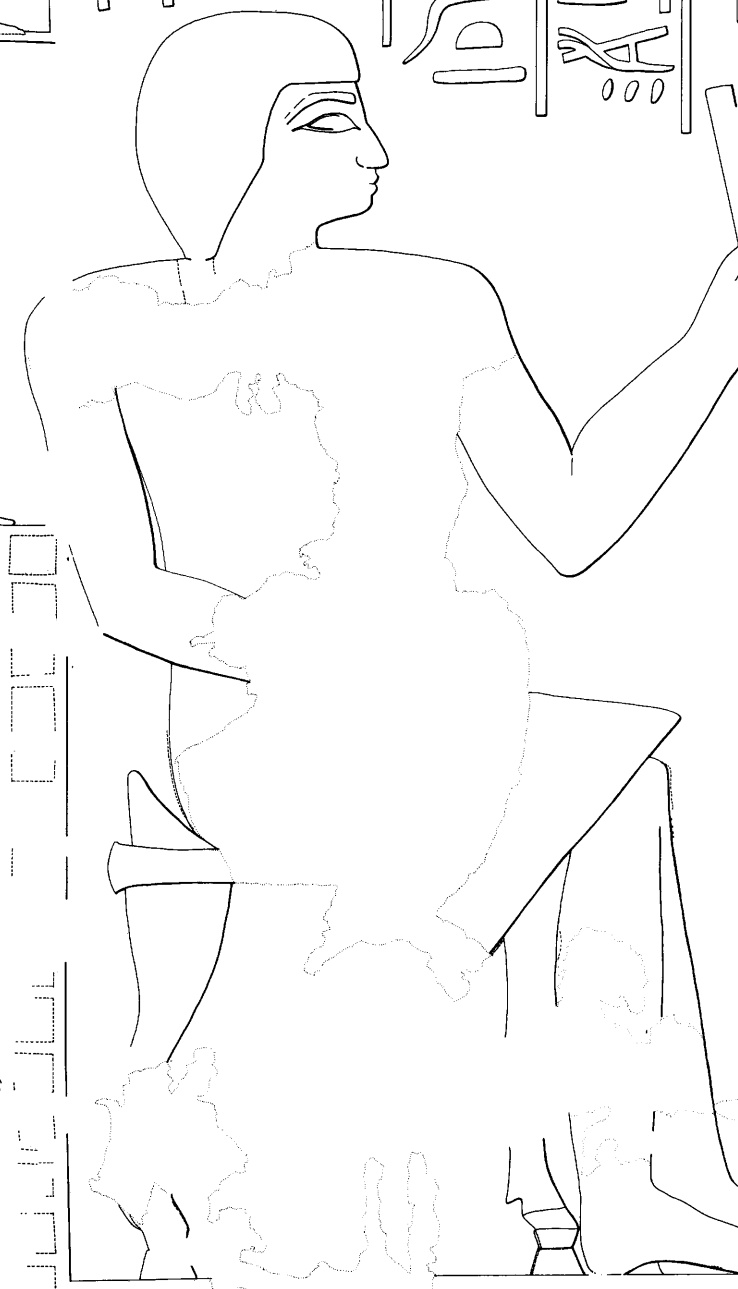

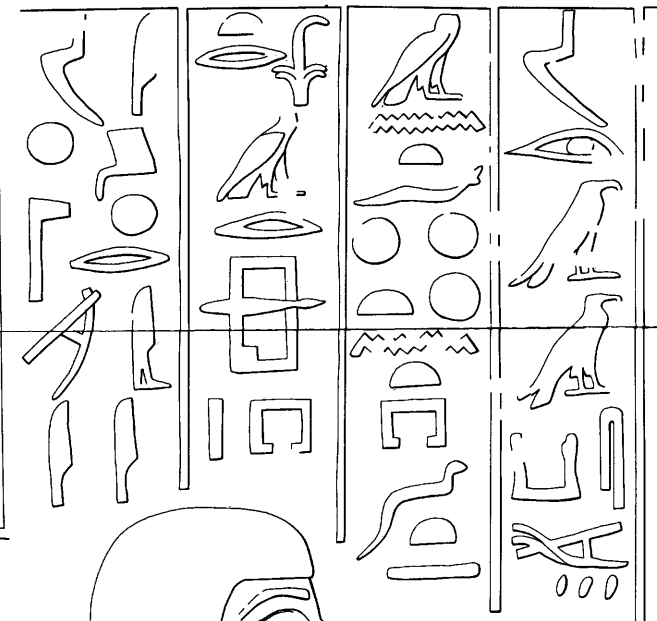
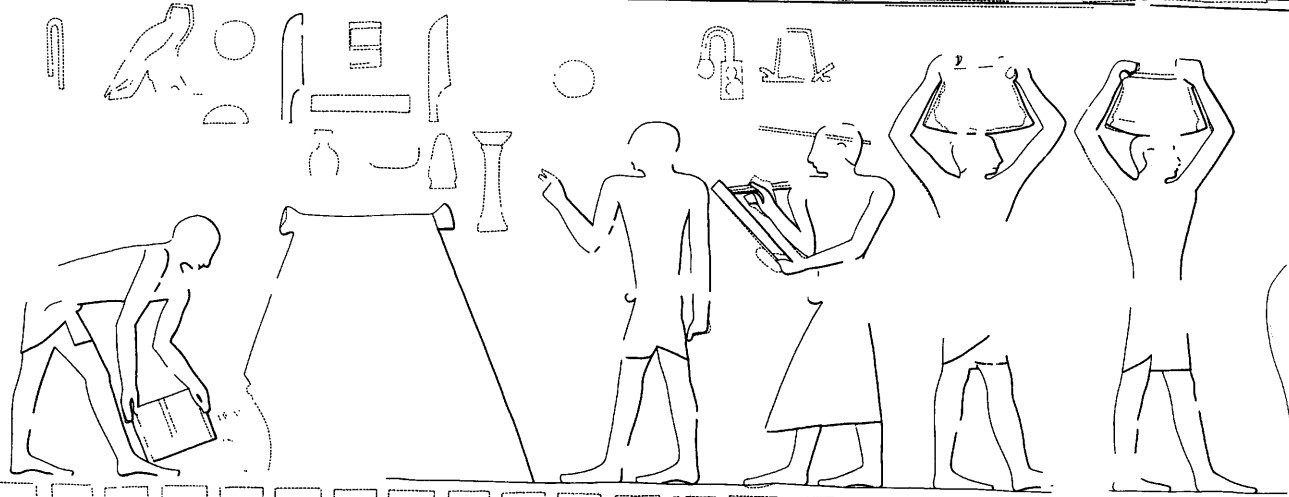
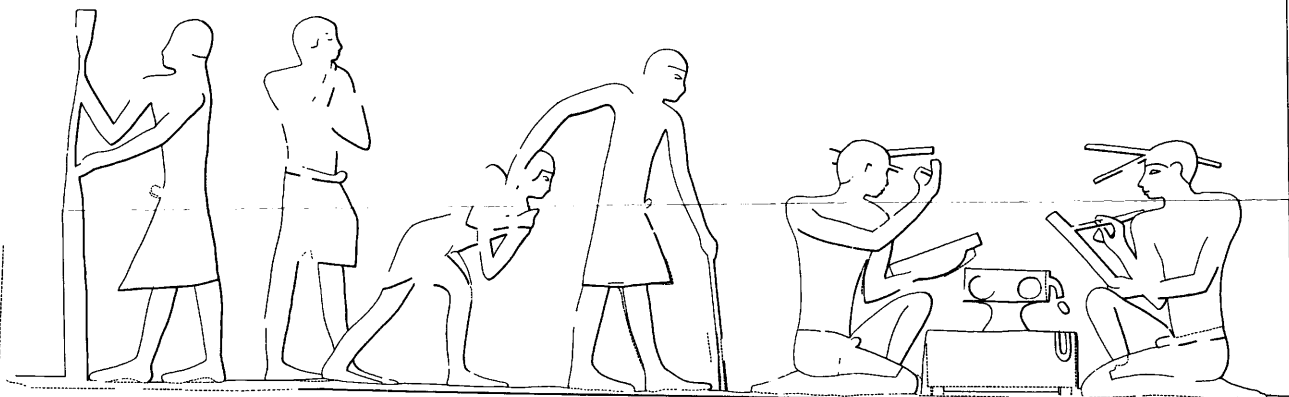
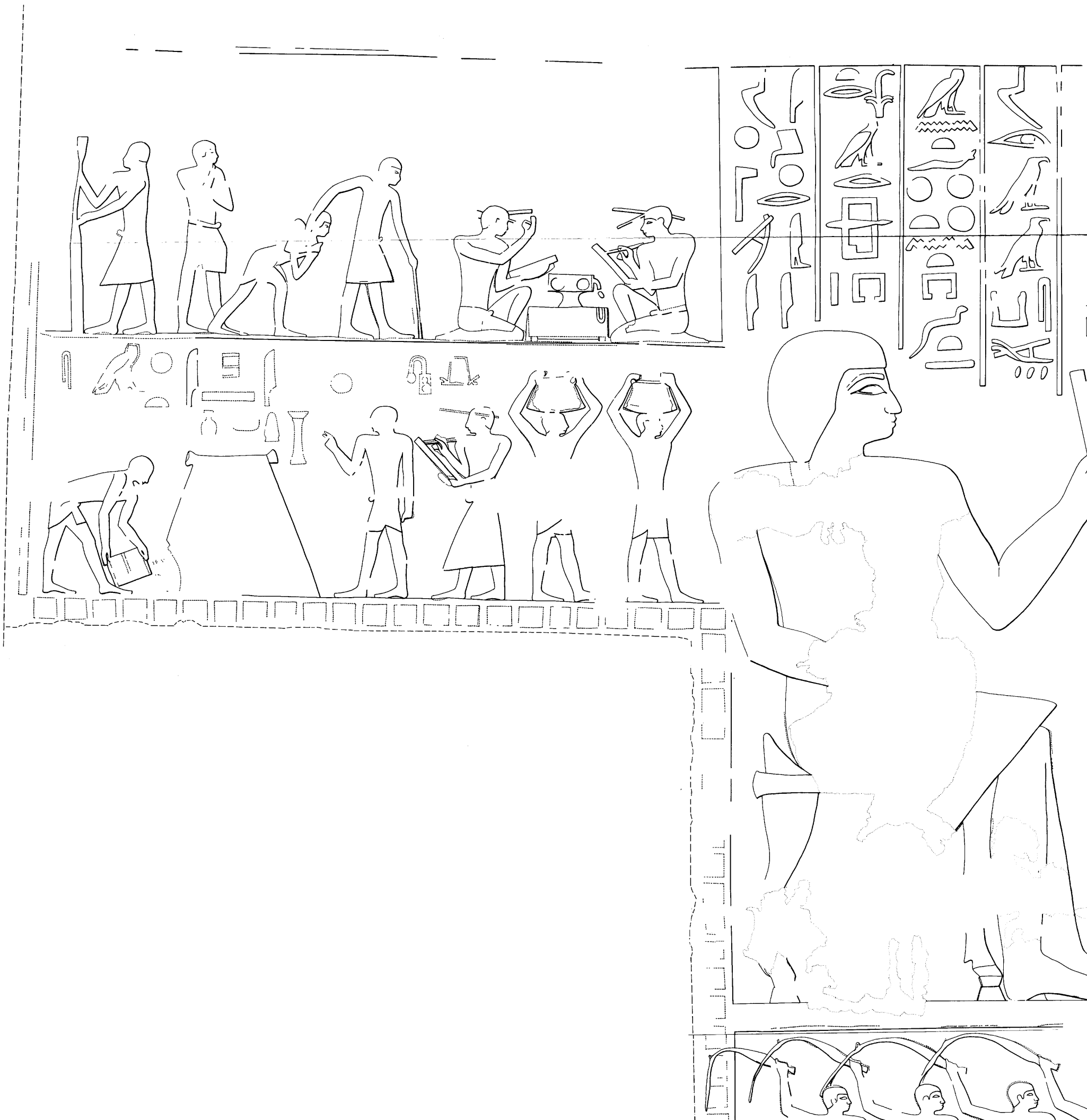

39. G 6020: Second chamber, north wall, above doorway and central area

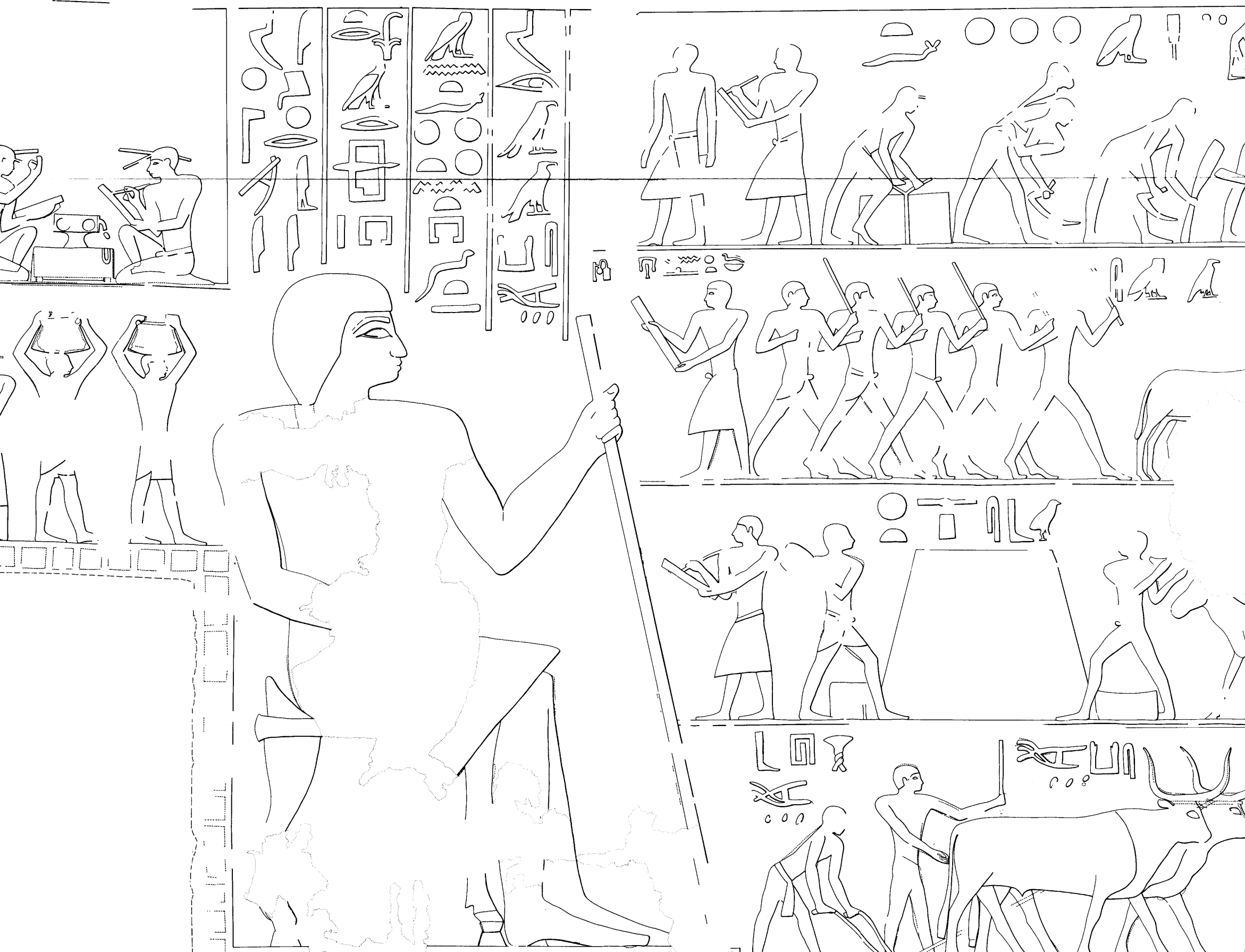

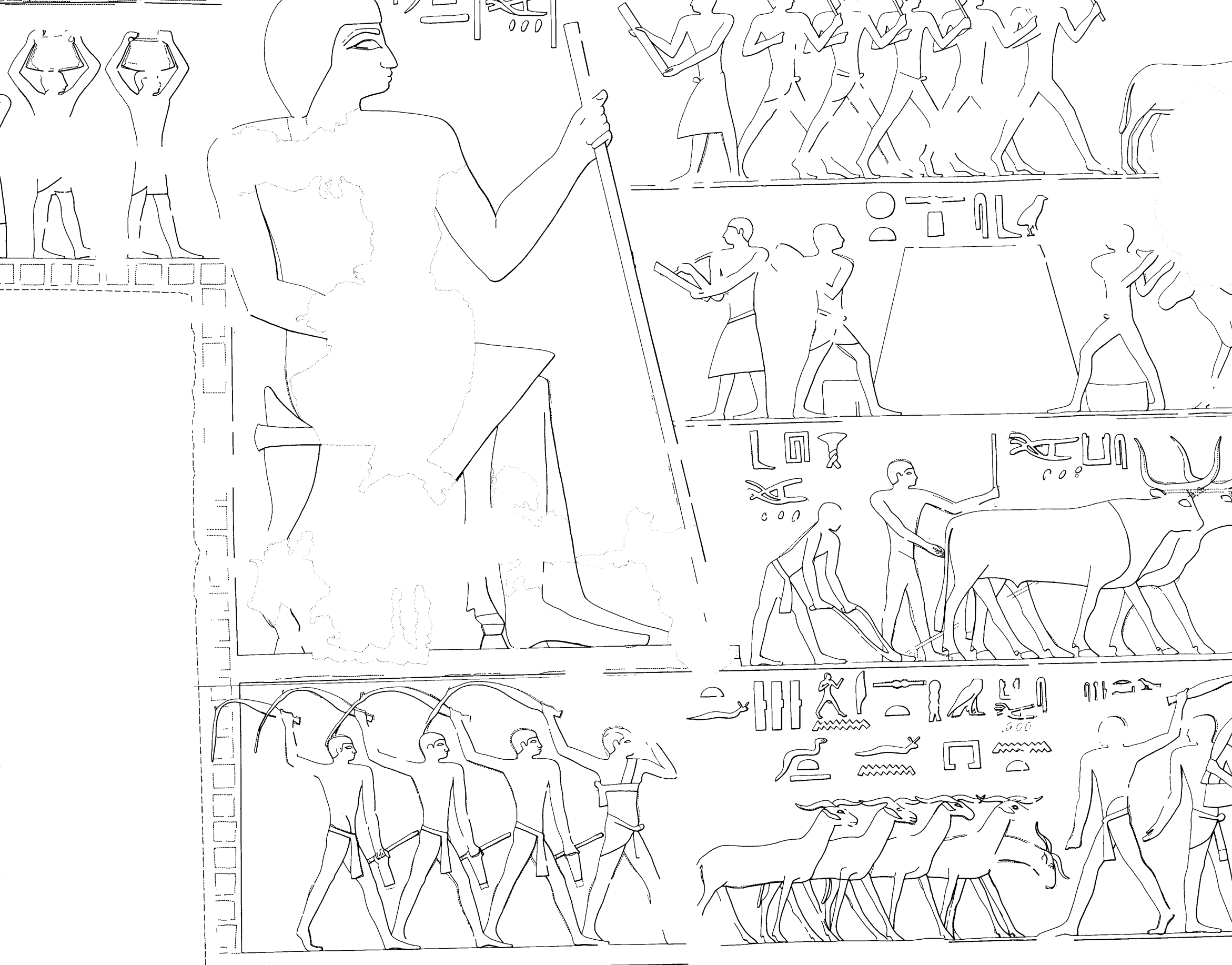

39. G 6020: Second chamber, north wall, above doorway and central section, texts [2.93-2.106]

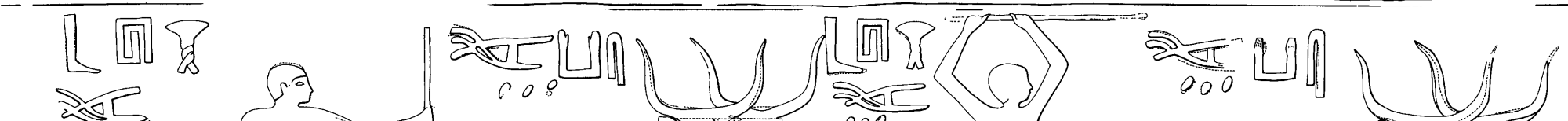
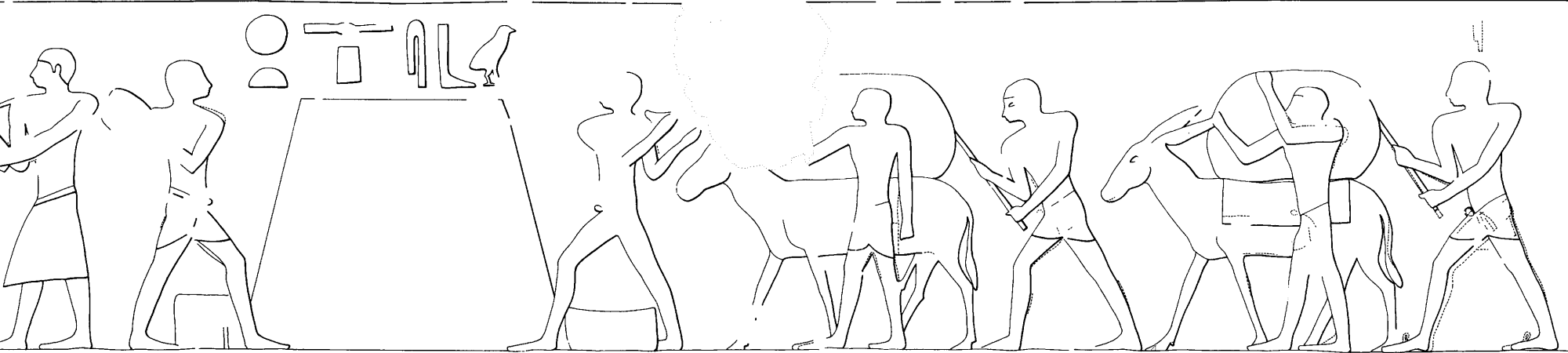
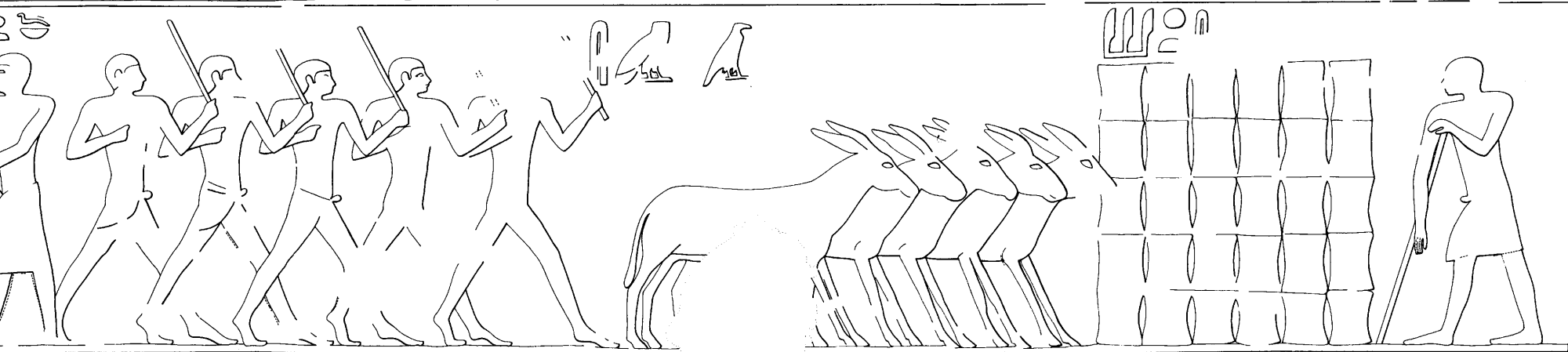
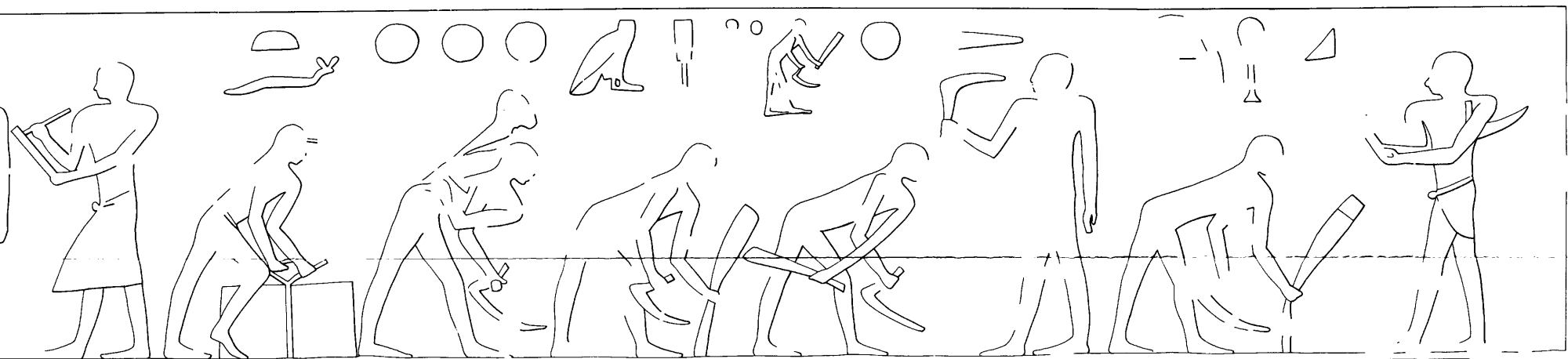

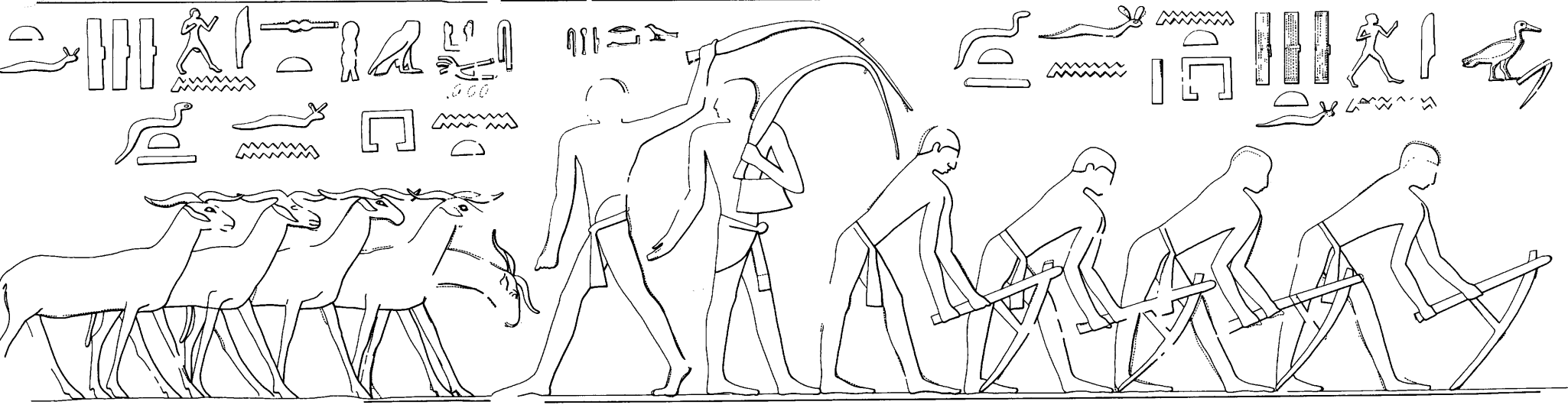
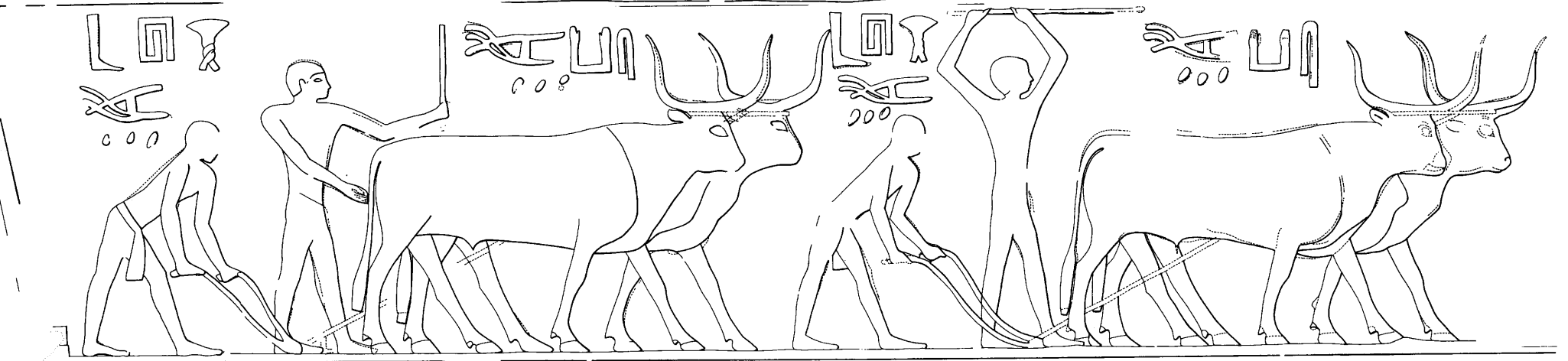
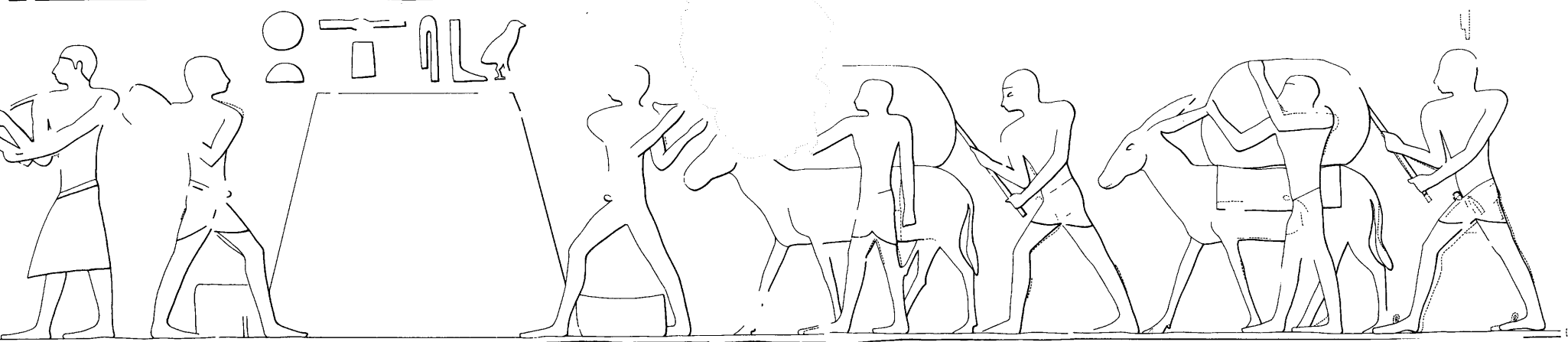
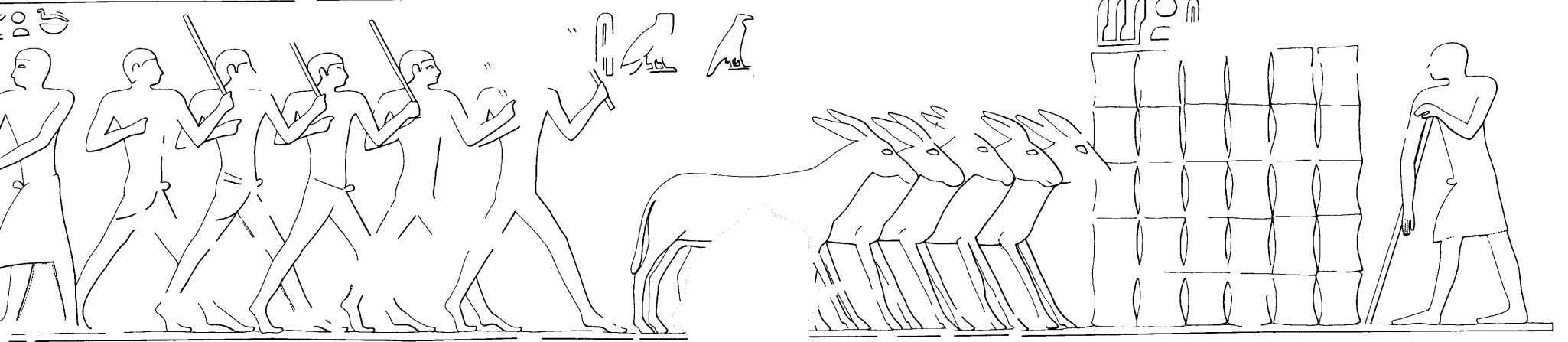



40. G 6020: Second chamber, north wall, eastern section, texts (2.107-2.109)

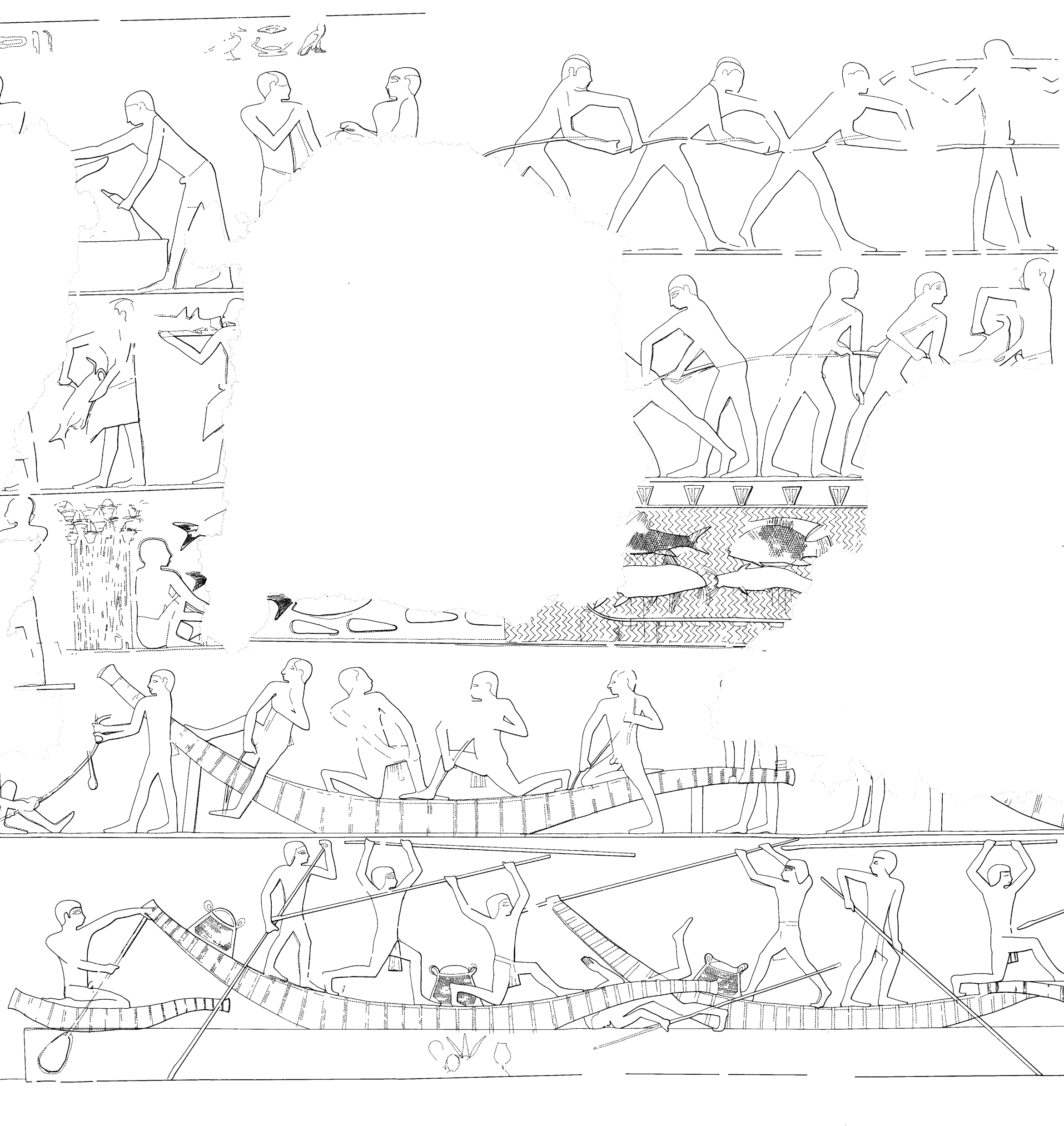

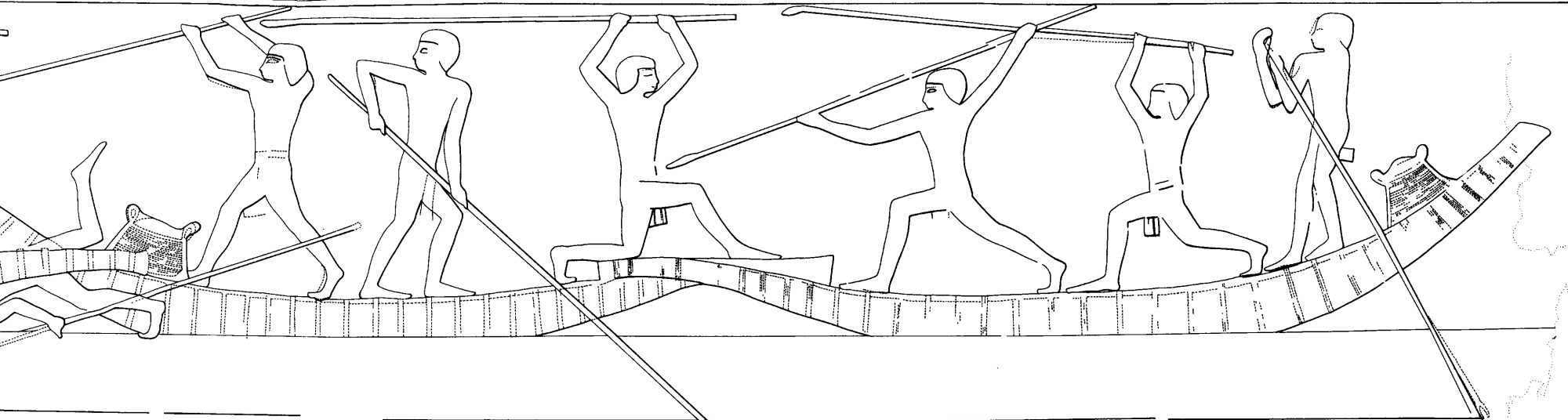
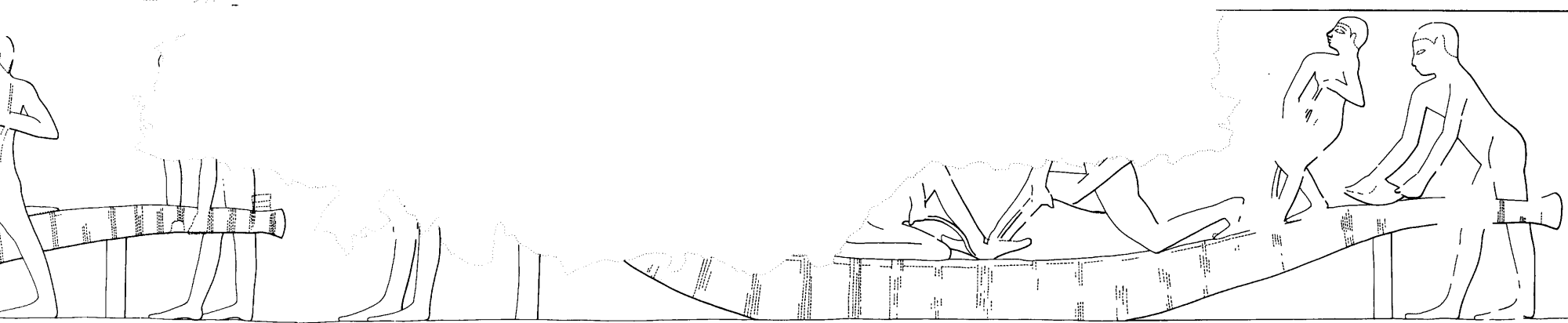
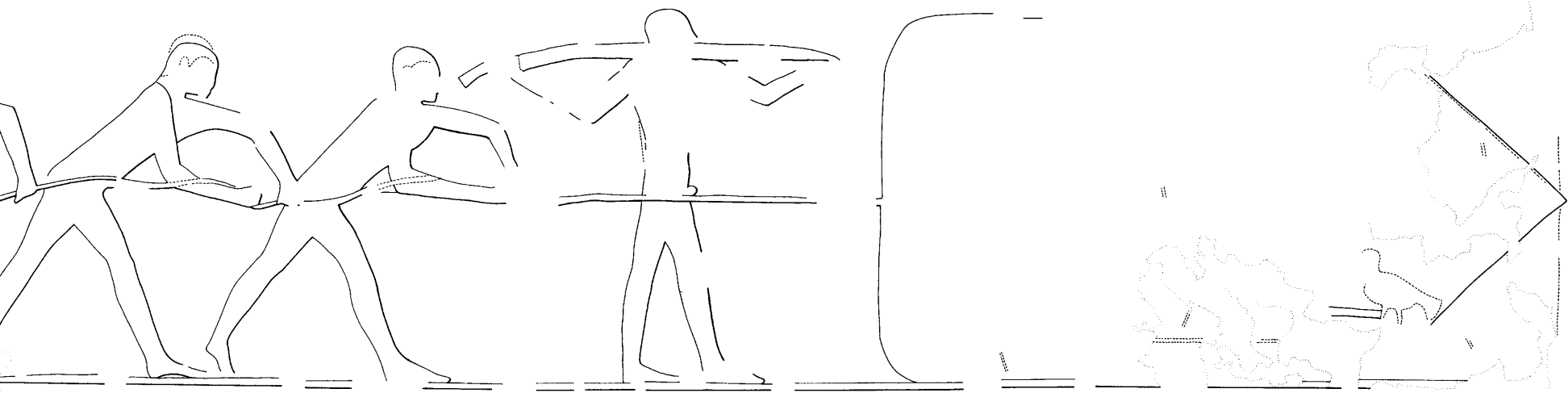

79



41. G 6020: Third chamber, east wall, northern section, texts [2.11]



41. G 6020: Third chamber, east wall, northern section, texts {2.110 -2.117}

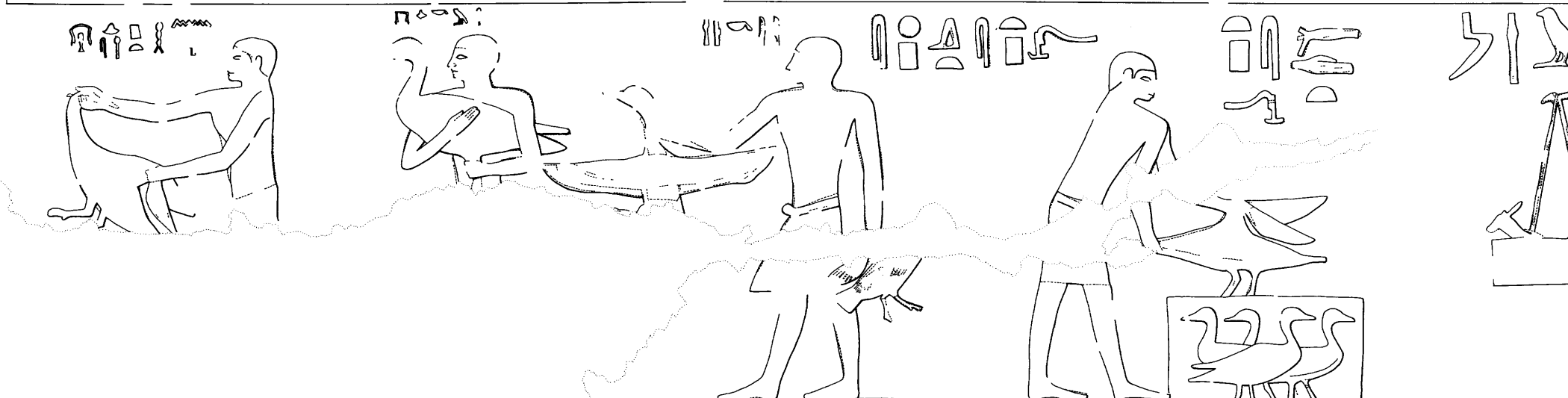
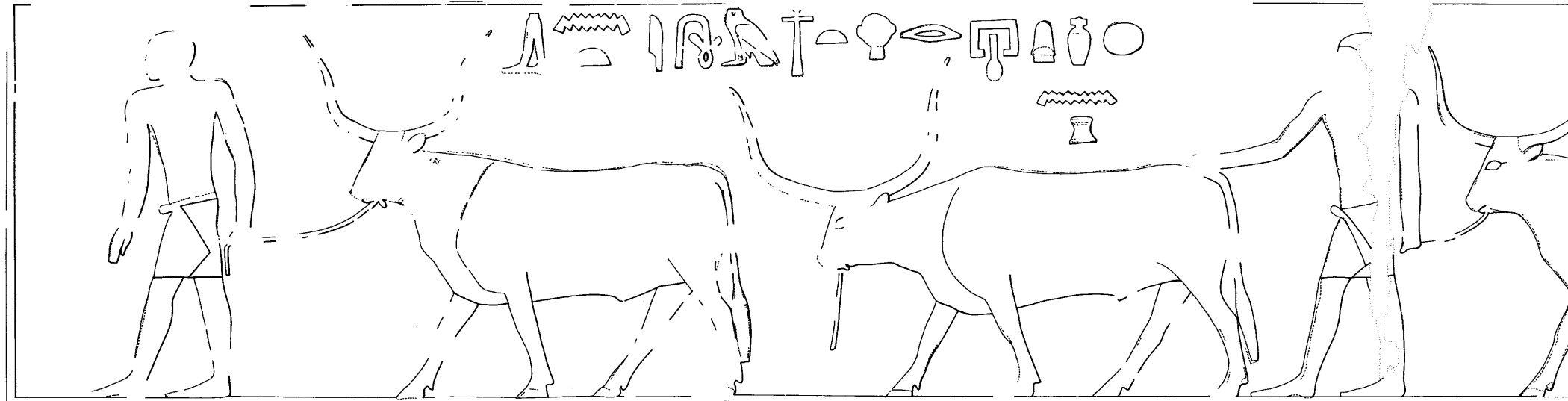
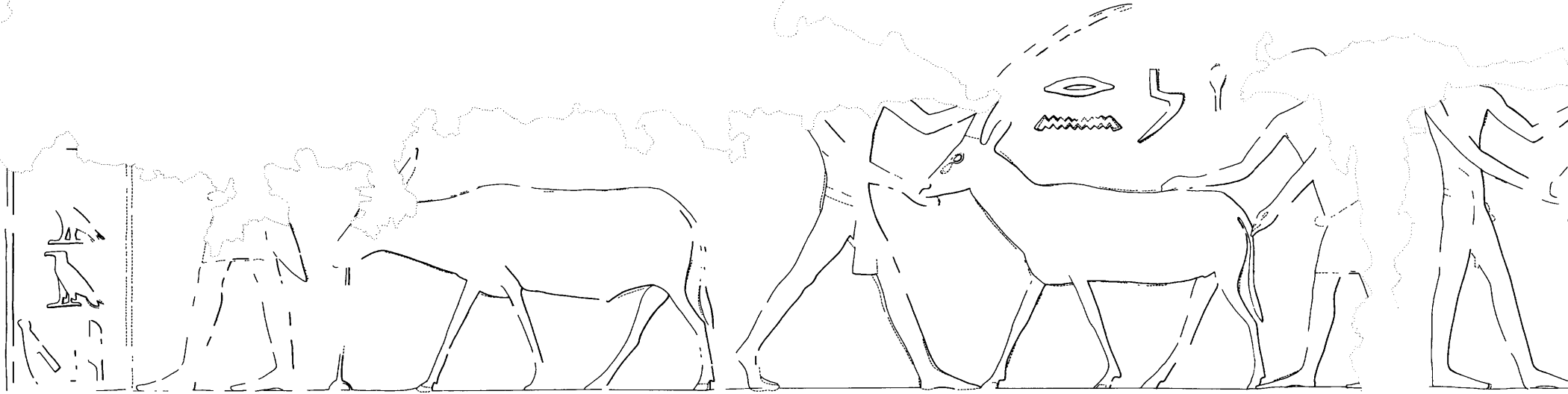
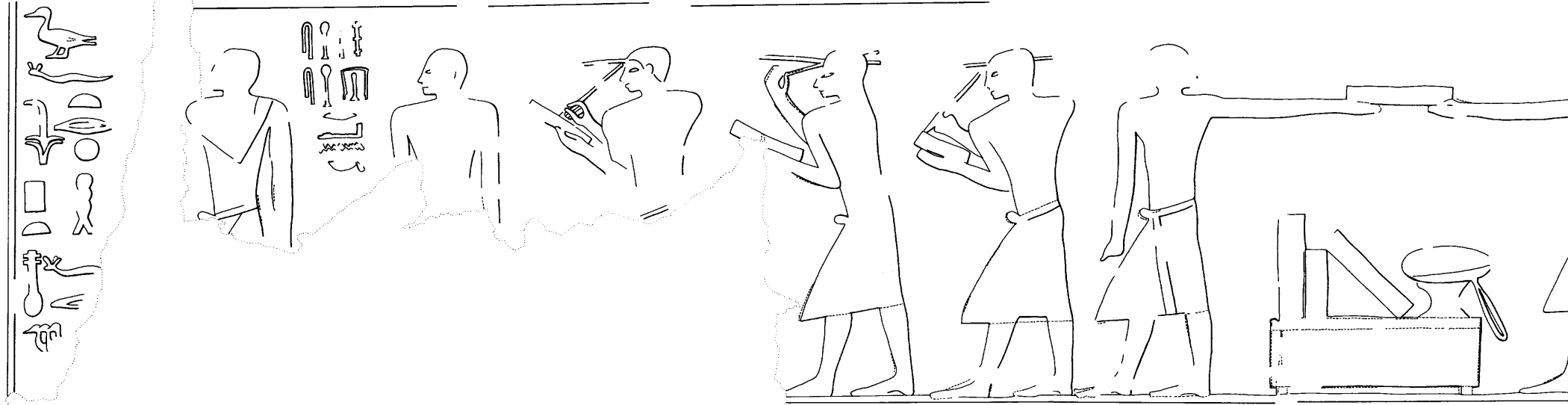

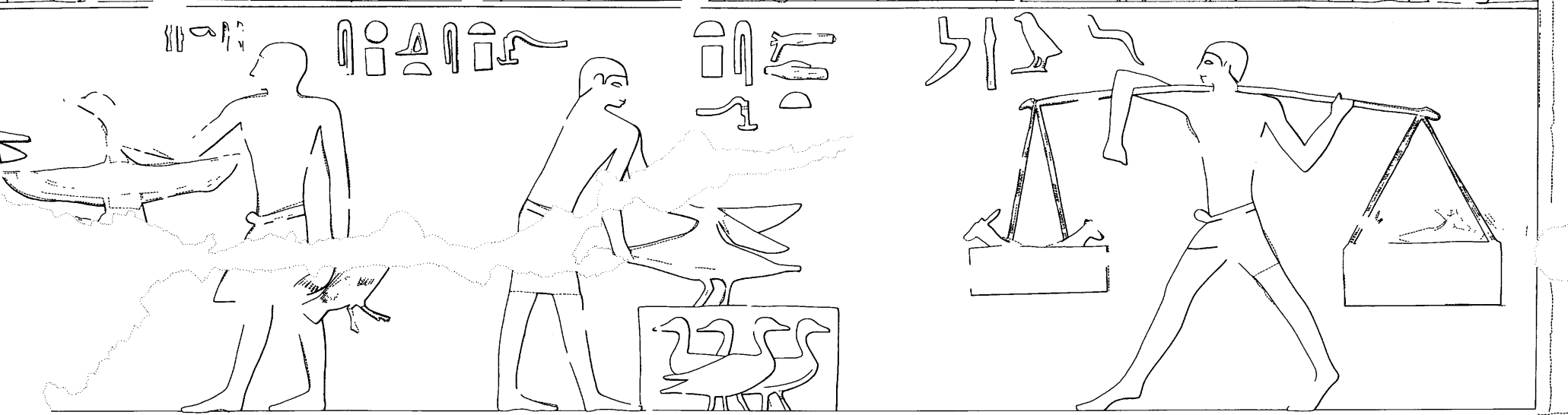
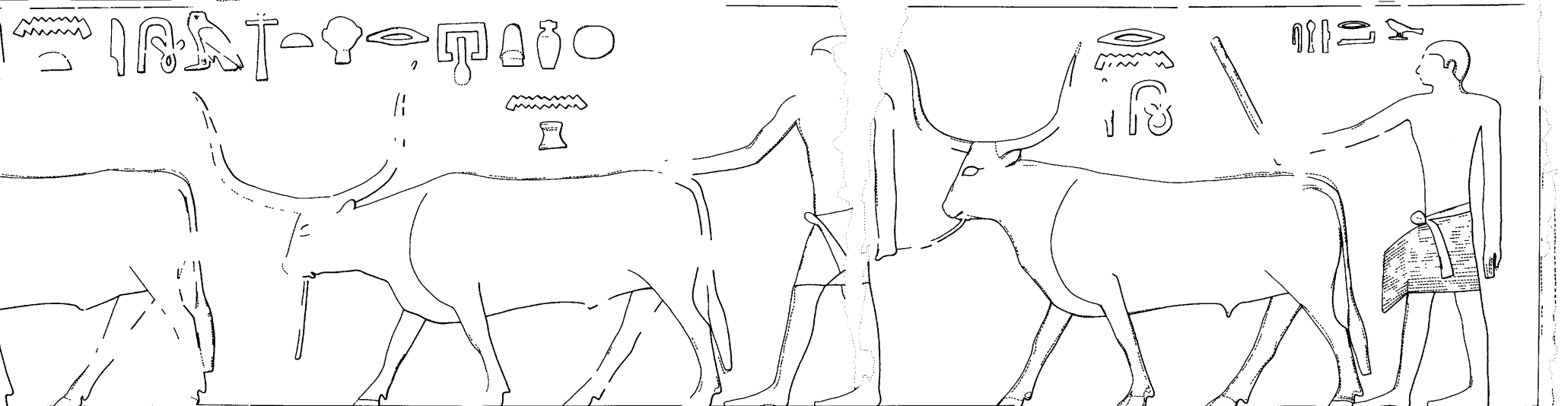
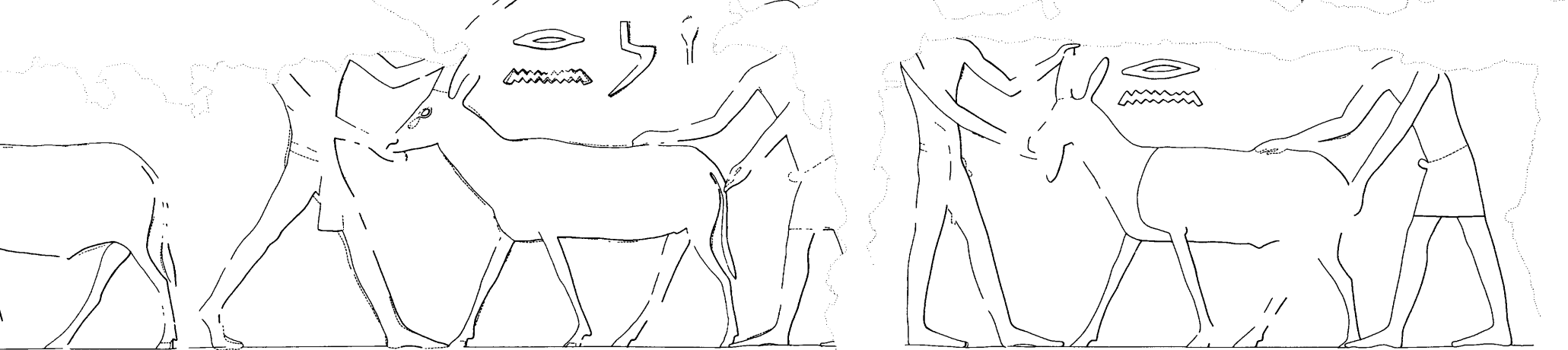
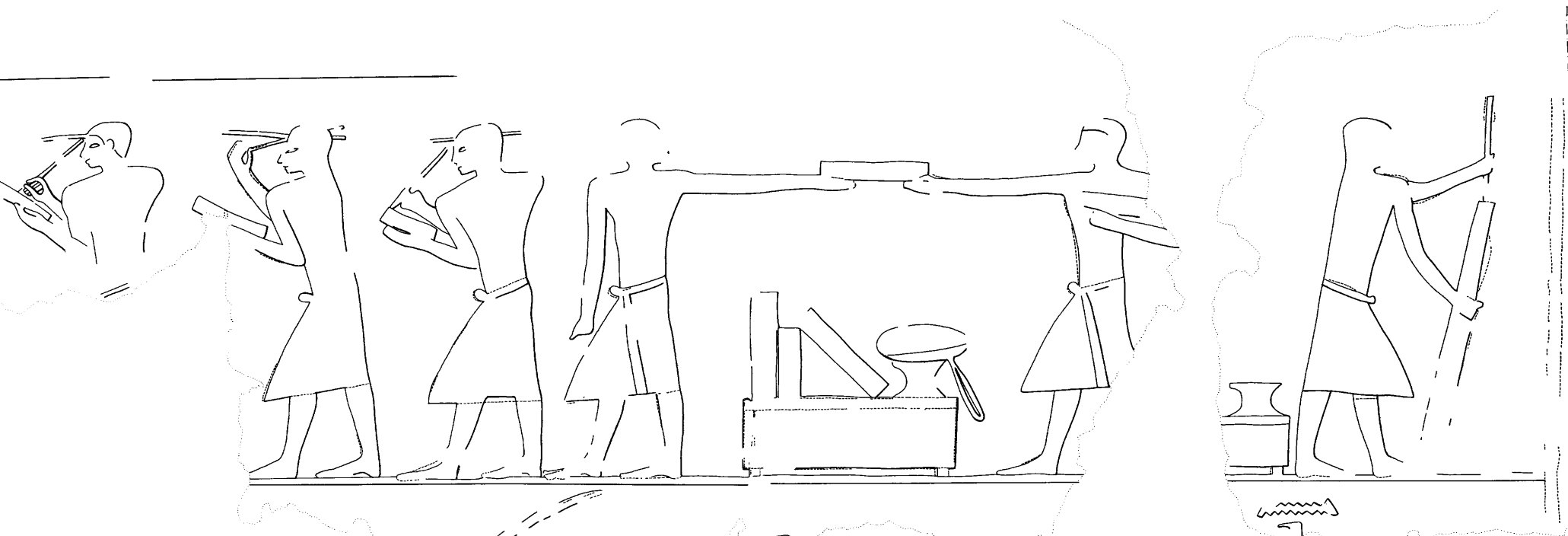

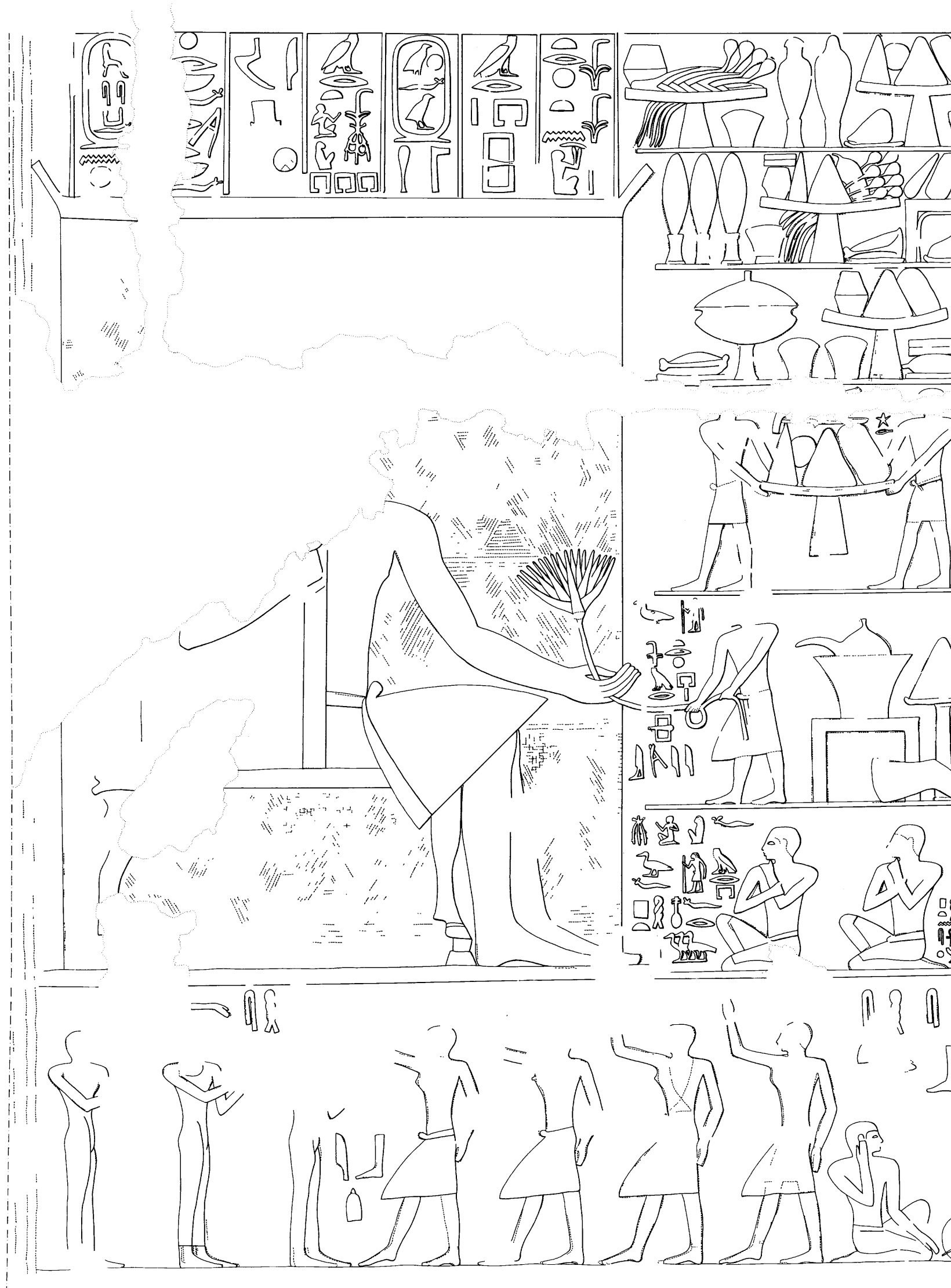

43. G 6020: Third chamber, south wall, texts [2.133–2.143]

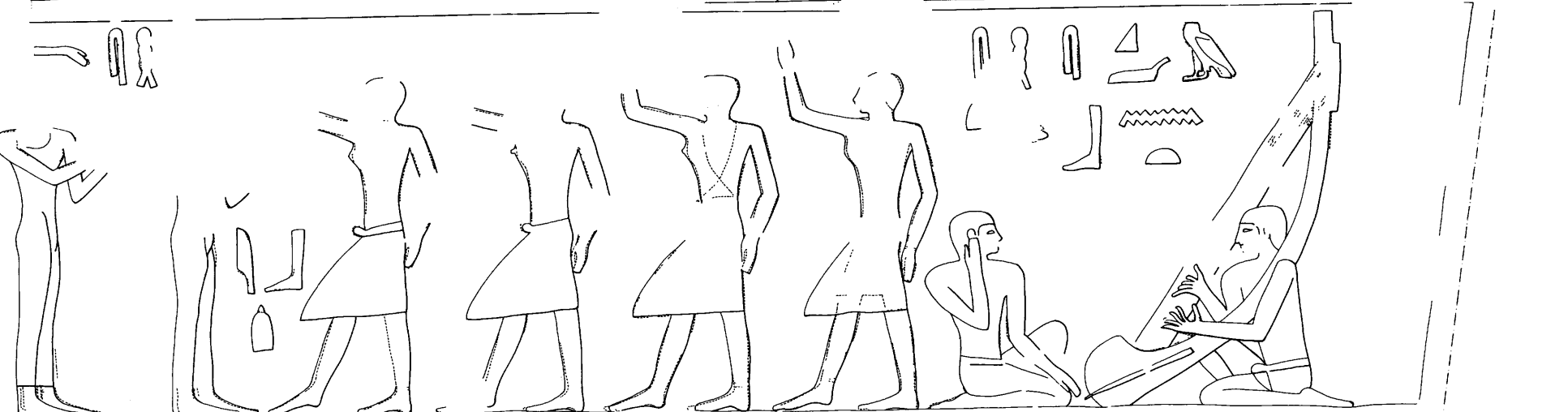
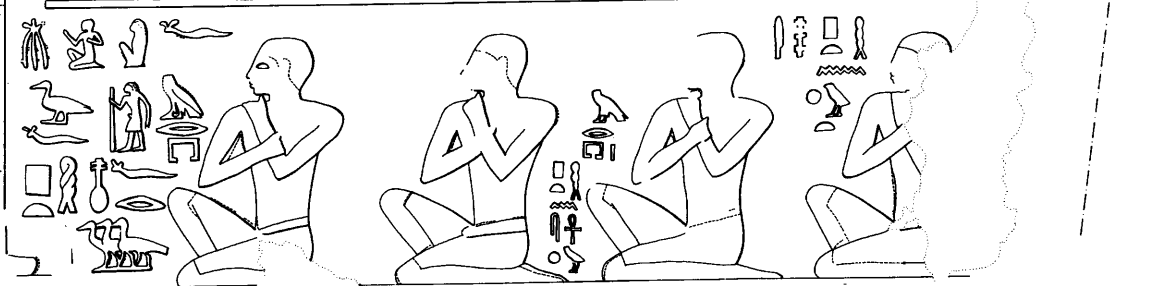
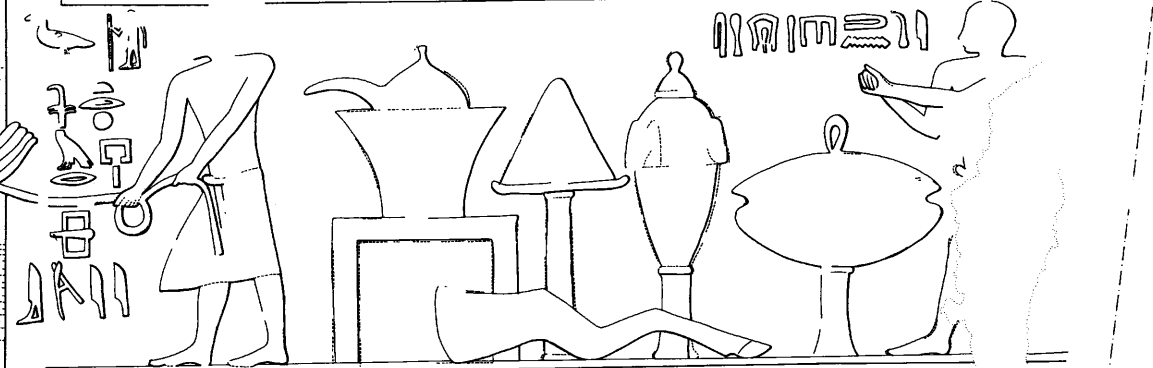
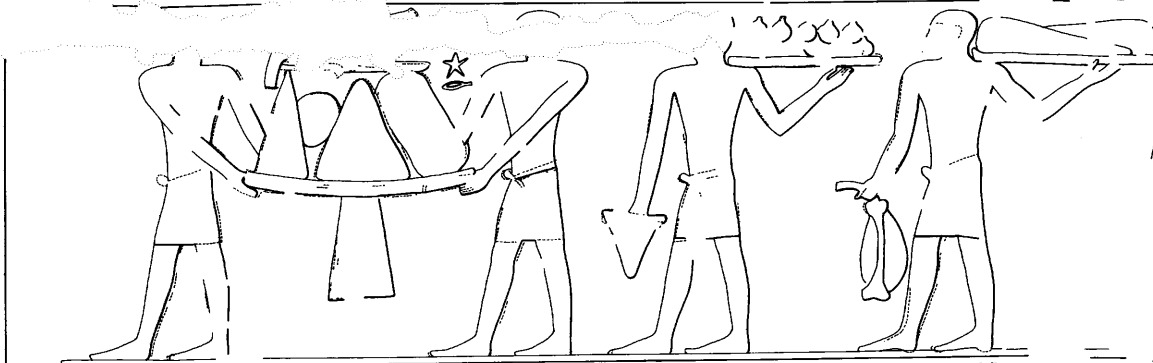
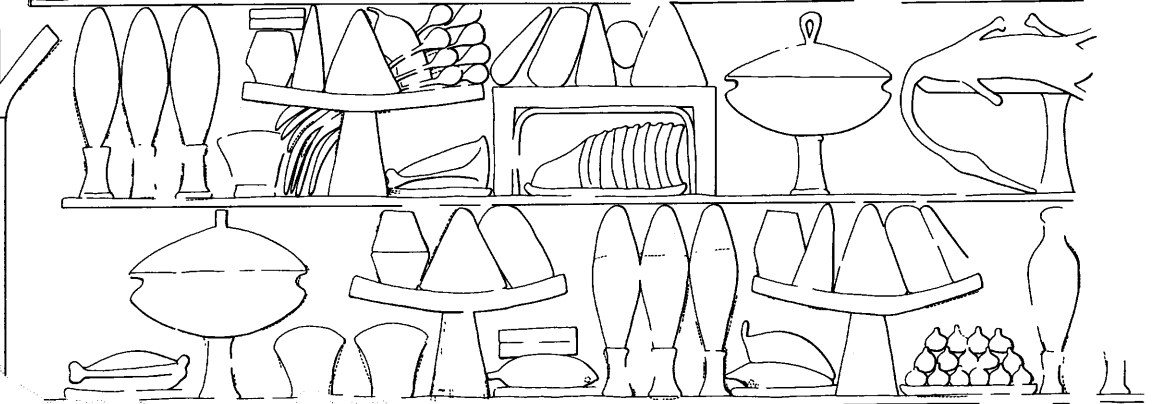
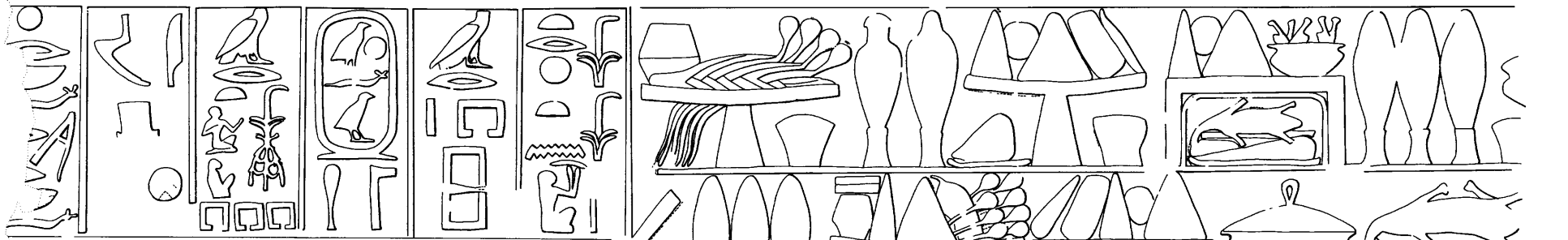

ber, south wall, texts (2.133-2.143)

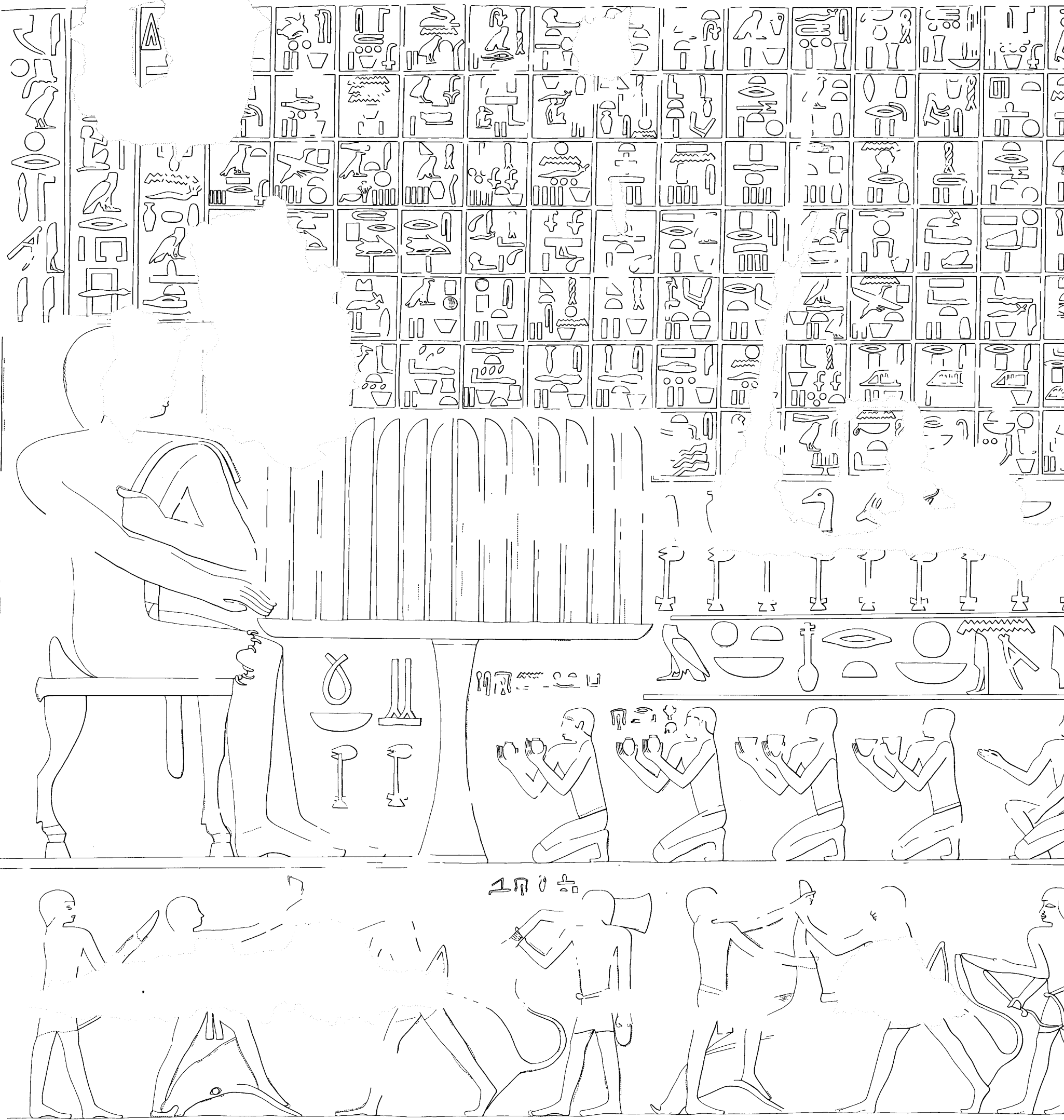

44. G 6020: Third chamber, west wall, southern section (including offering list), texts [2.144–2.151]

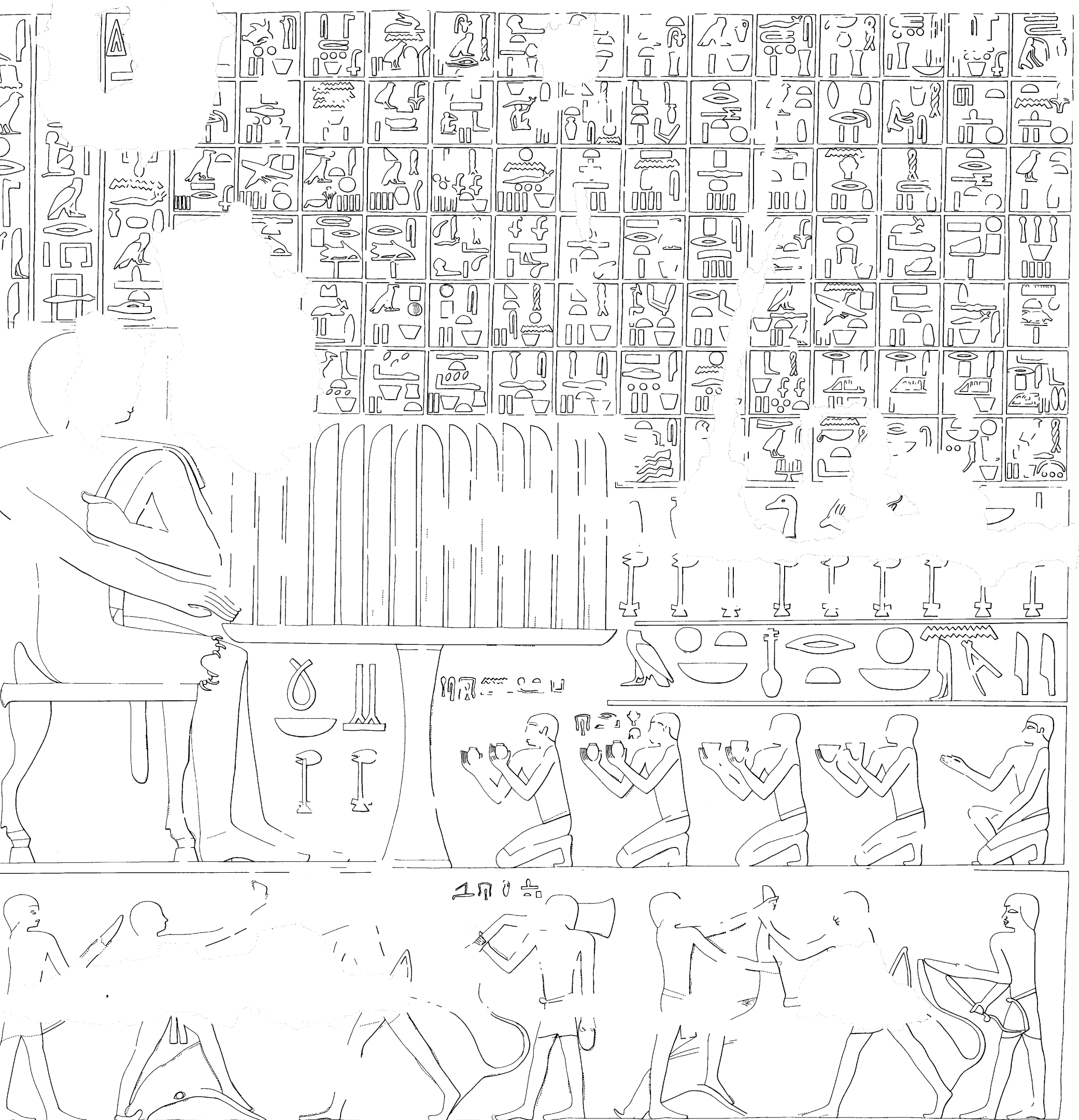

Third chamber, west wall, southern section (including offering list), texts [2.144–2.151]



45. G 6020: Third chamber, west wall, northern section, texts {2.152-1.153}

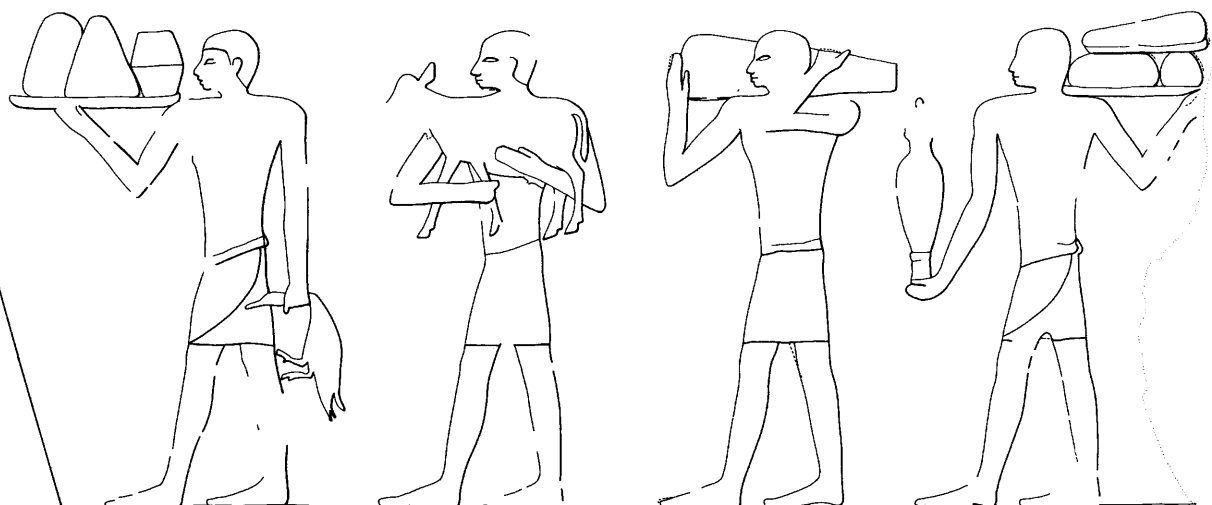
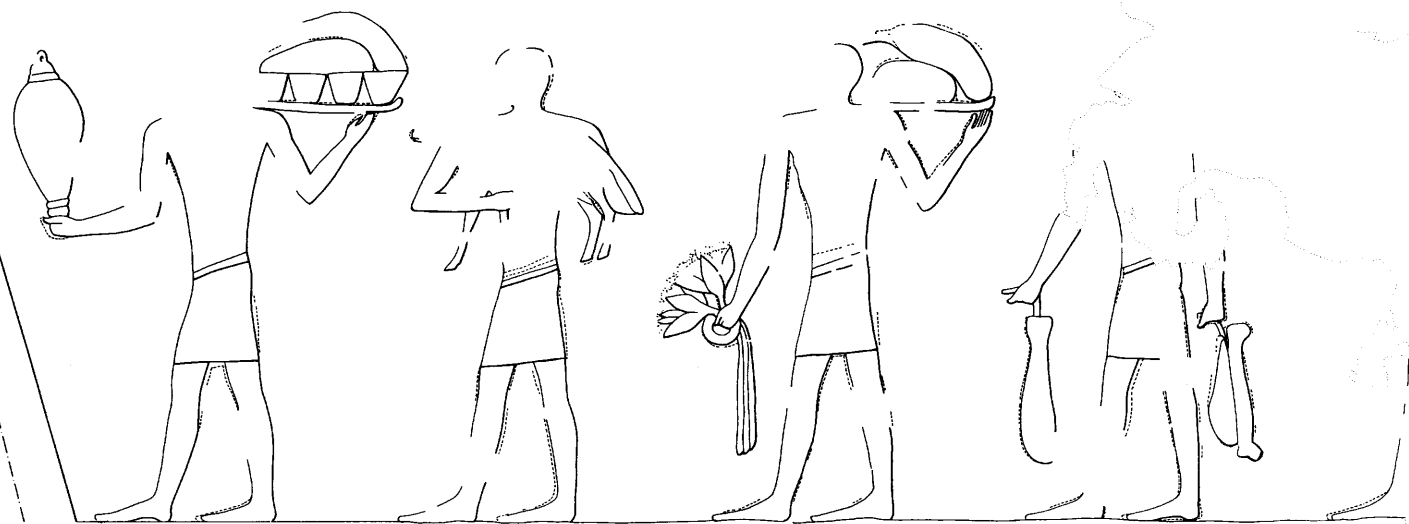
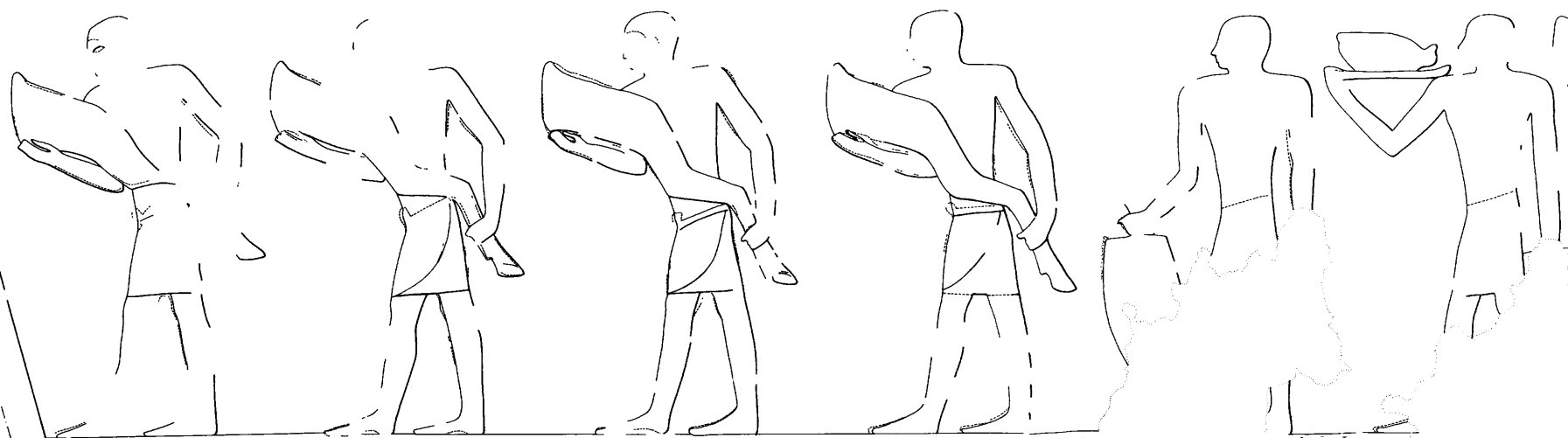

46. G 6020: Third chamber, north wall, first register, texts (2.154–2.156)

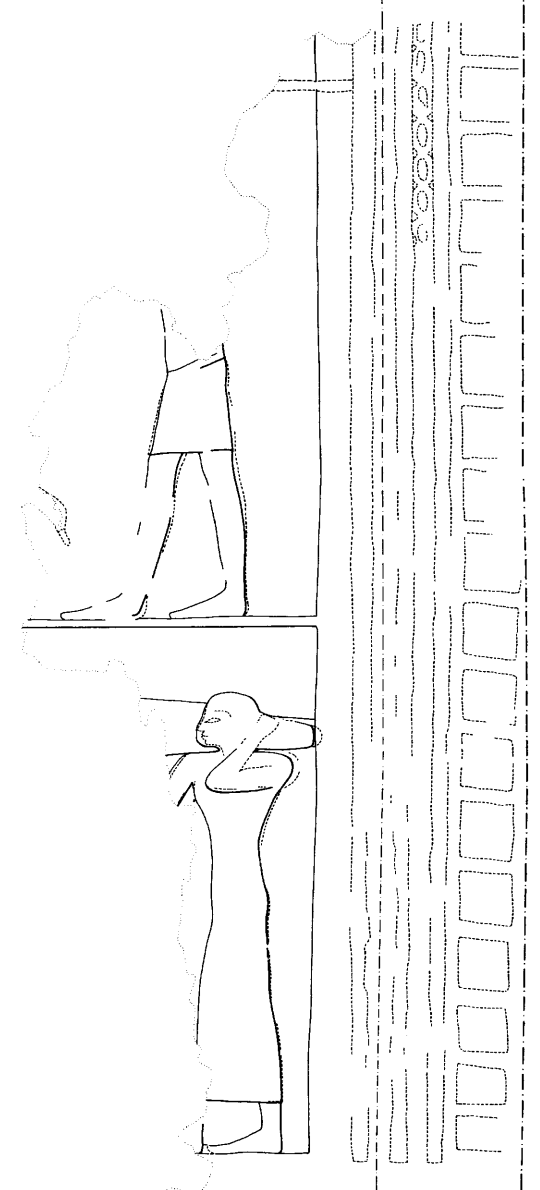
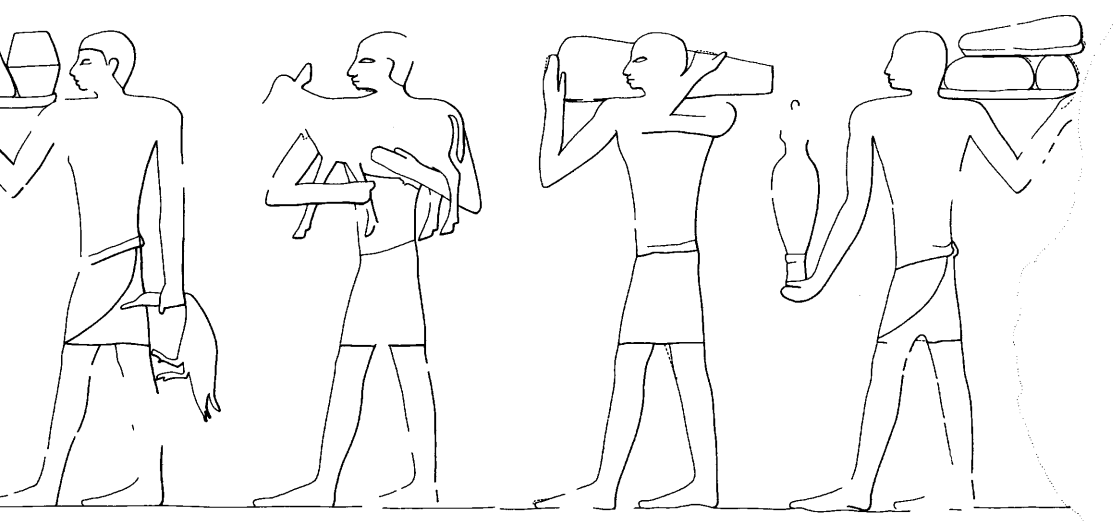
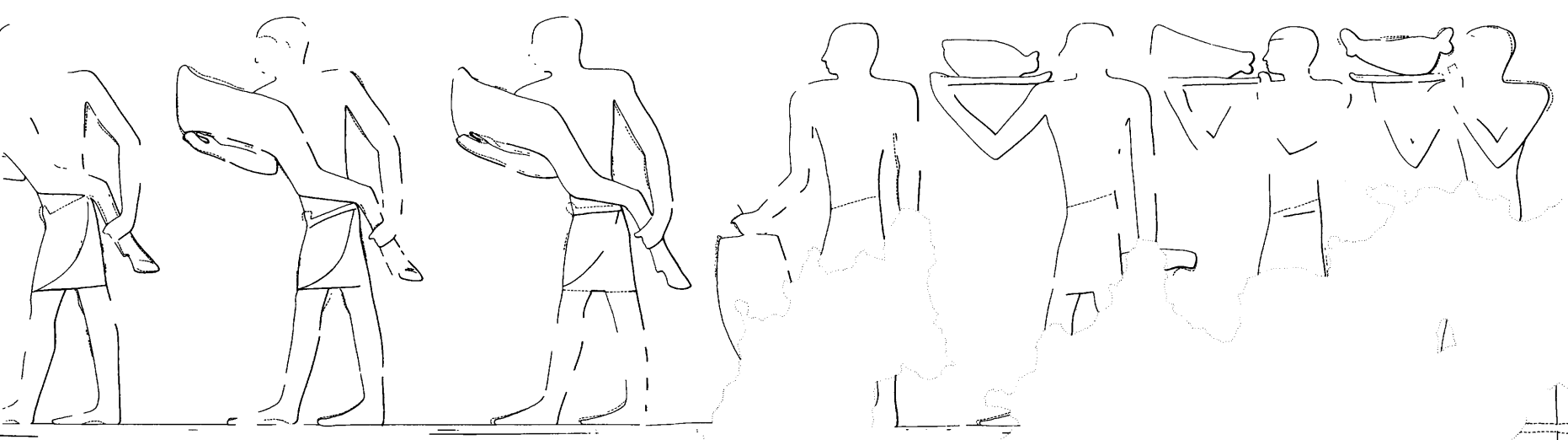
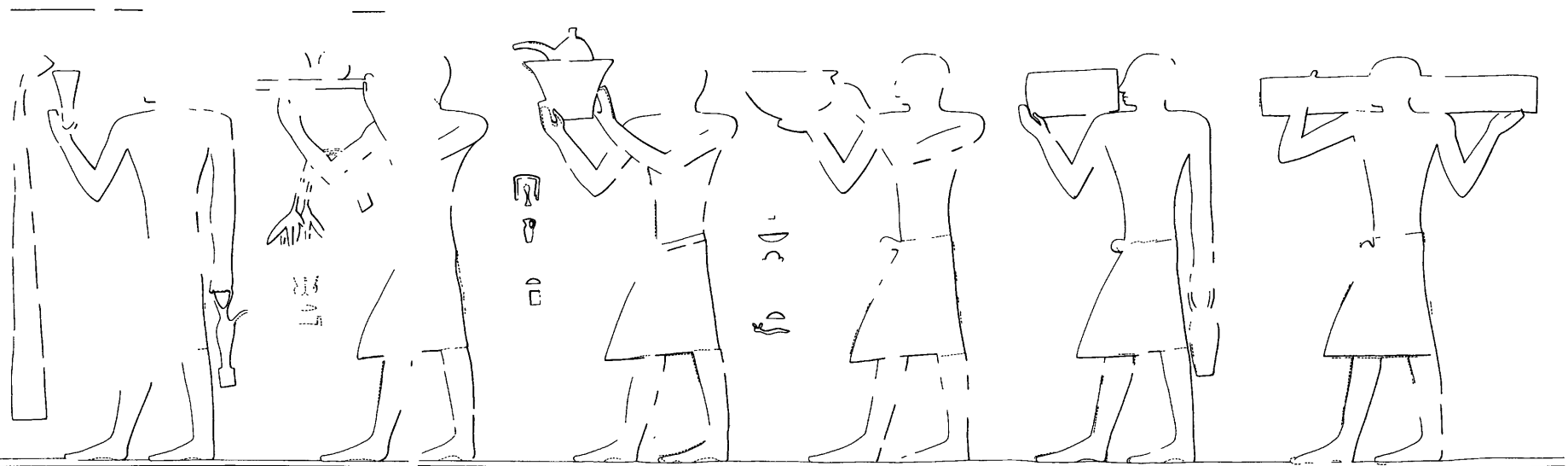

: Third chamber, north wall, first register, texts {2.154-2.156}



47. G 6030: Entrance, outer face, south side, standing figure of Ity

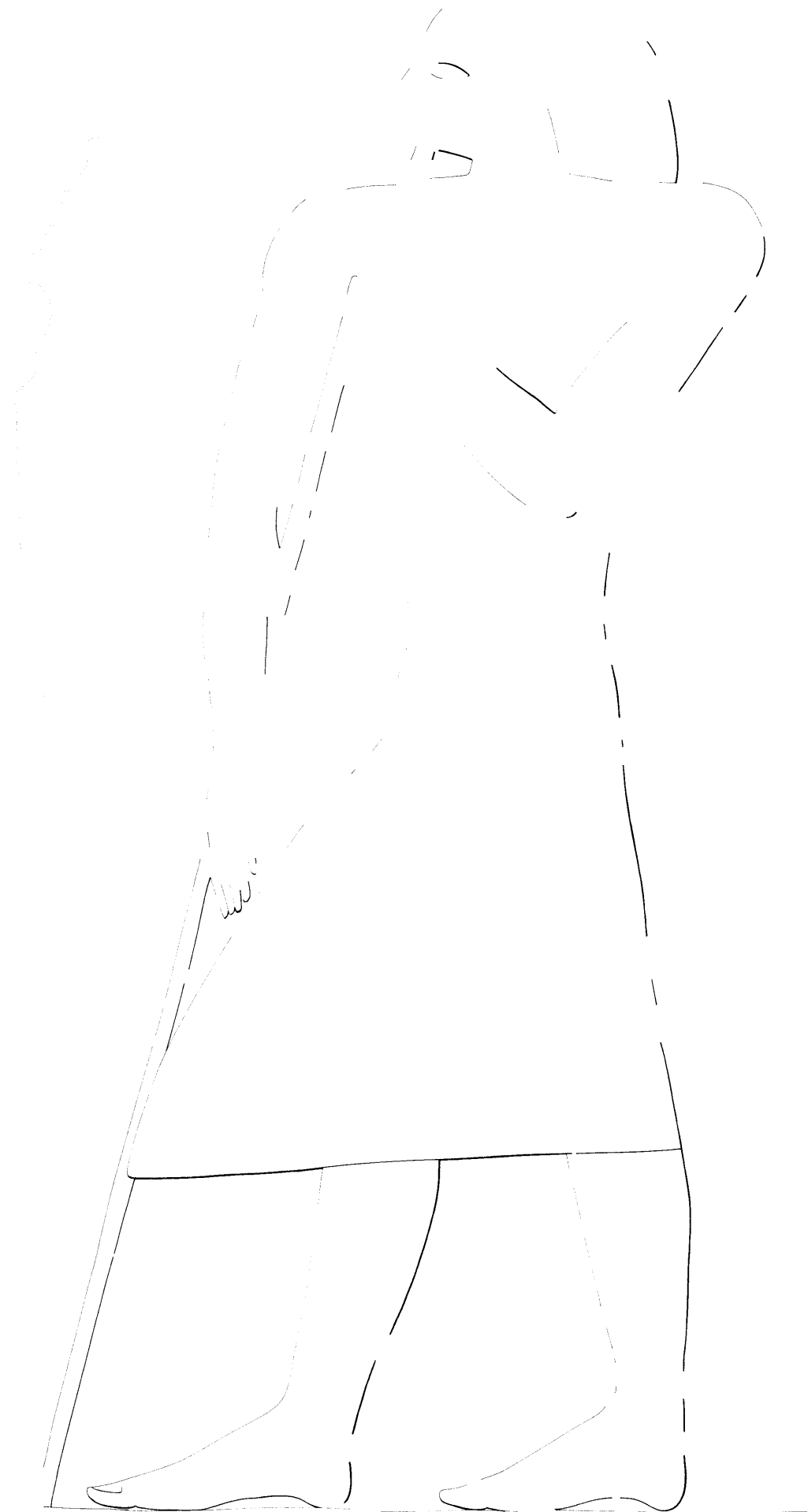

48. G 6030: Entrance, outer face, north side, standing figure of Ity

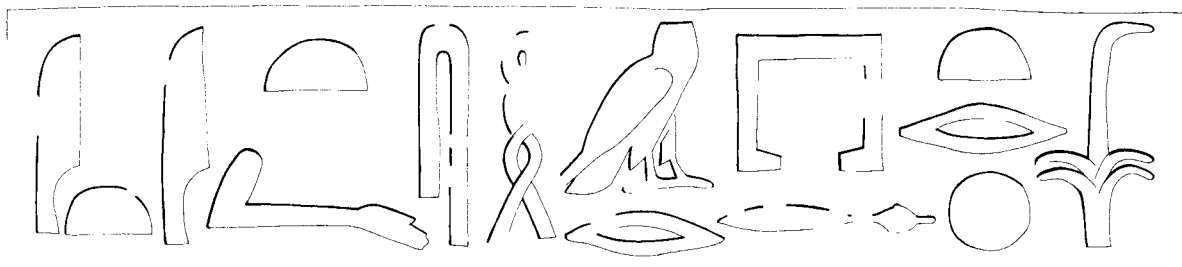
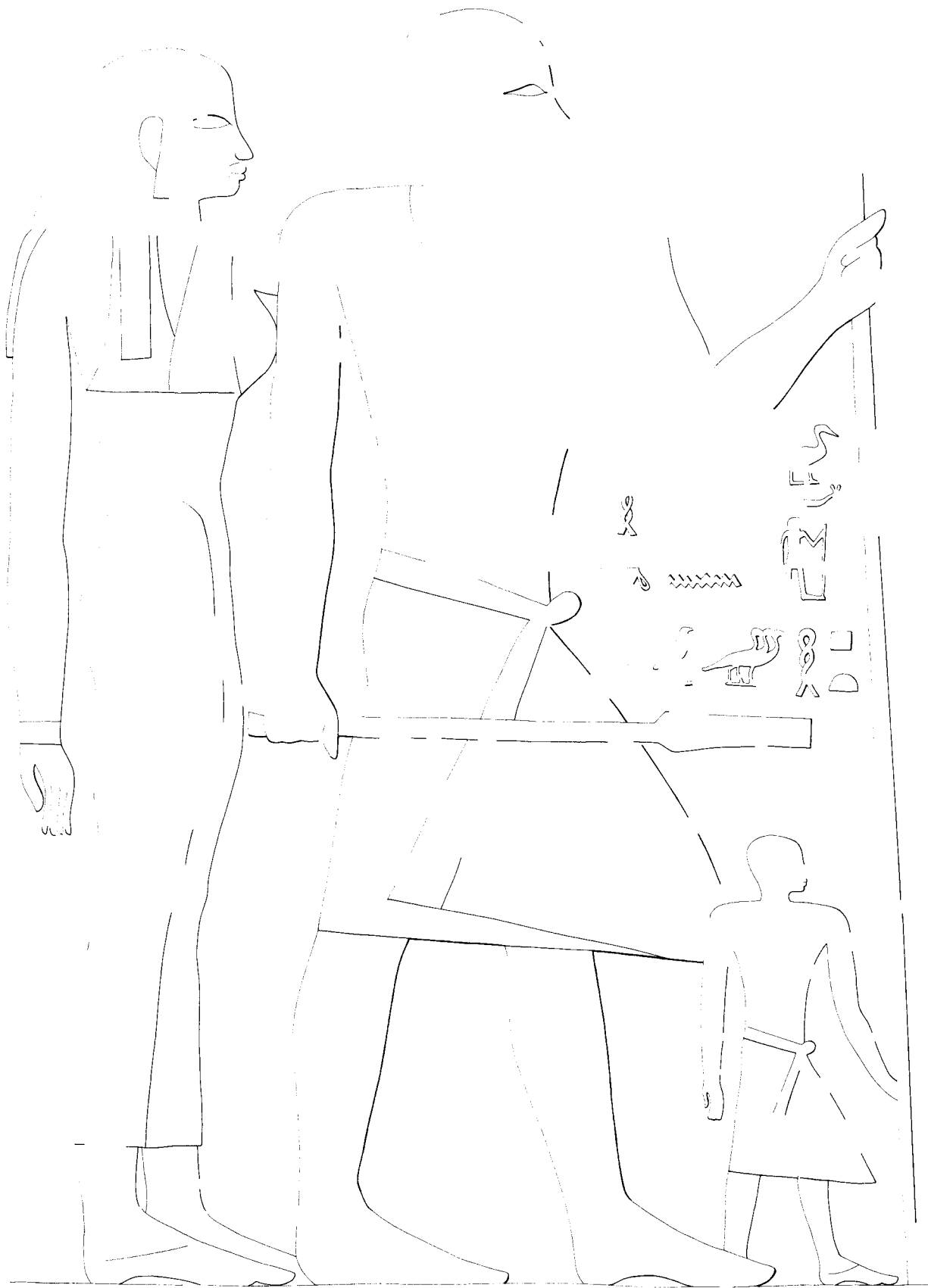

49. G 6030: Entrance, lintel and northern jamb, texts {3.1-3.4}



50. G 6030: Entrance, southern jamb, texts [3.2-3.3]

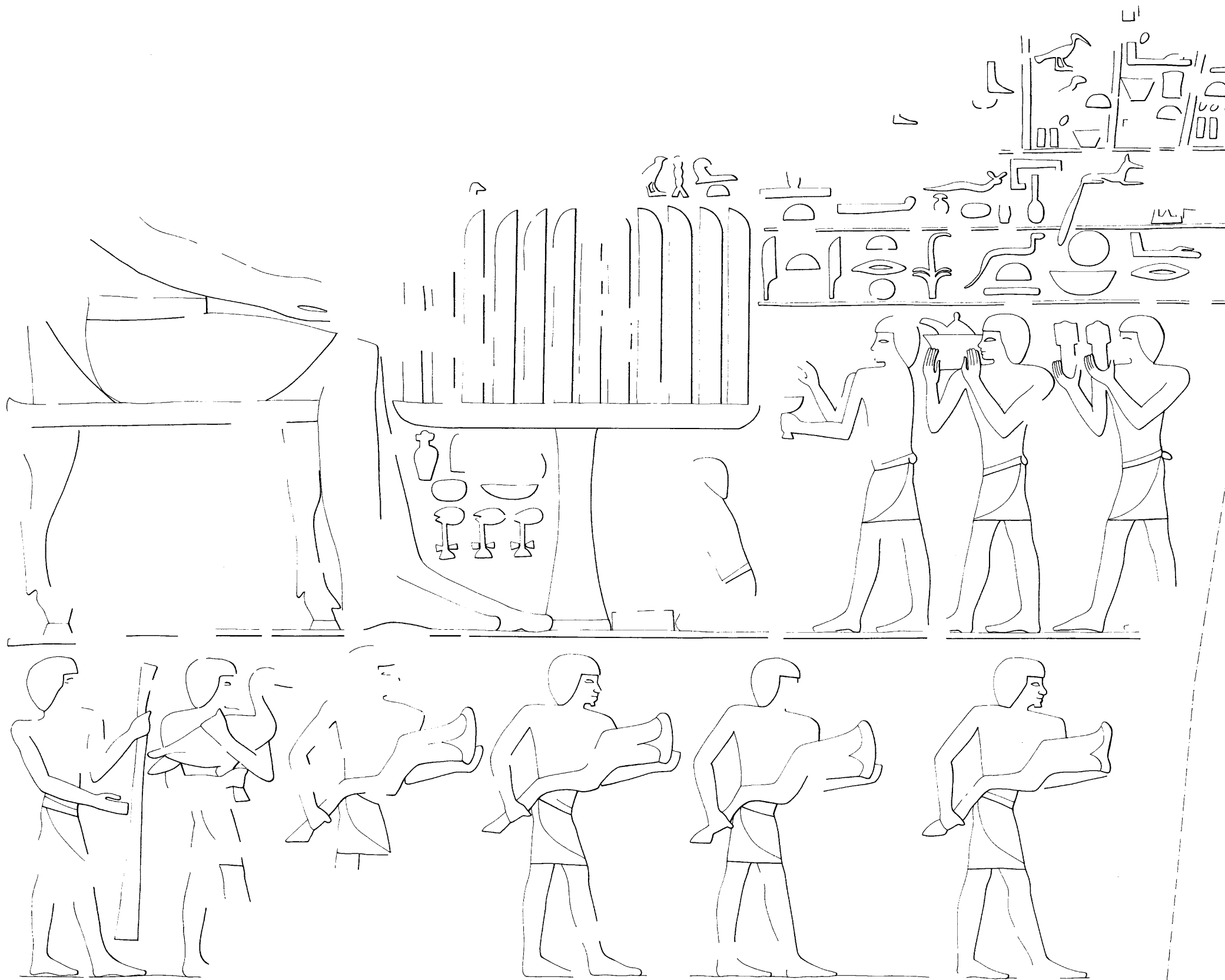

51. G 6030: South wall, texts [3.4-3.8]

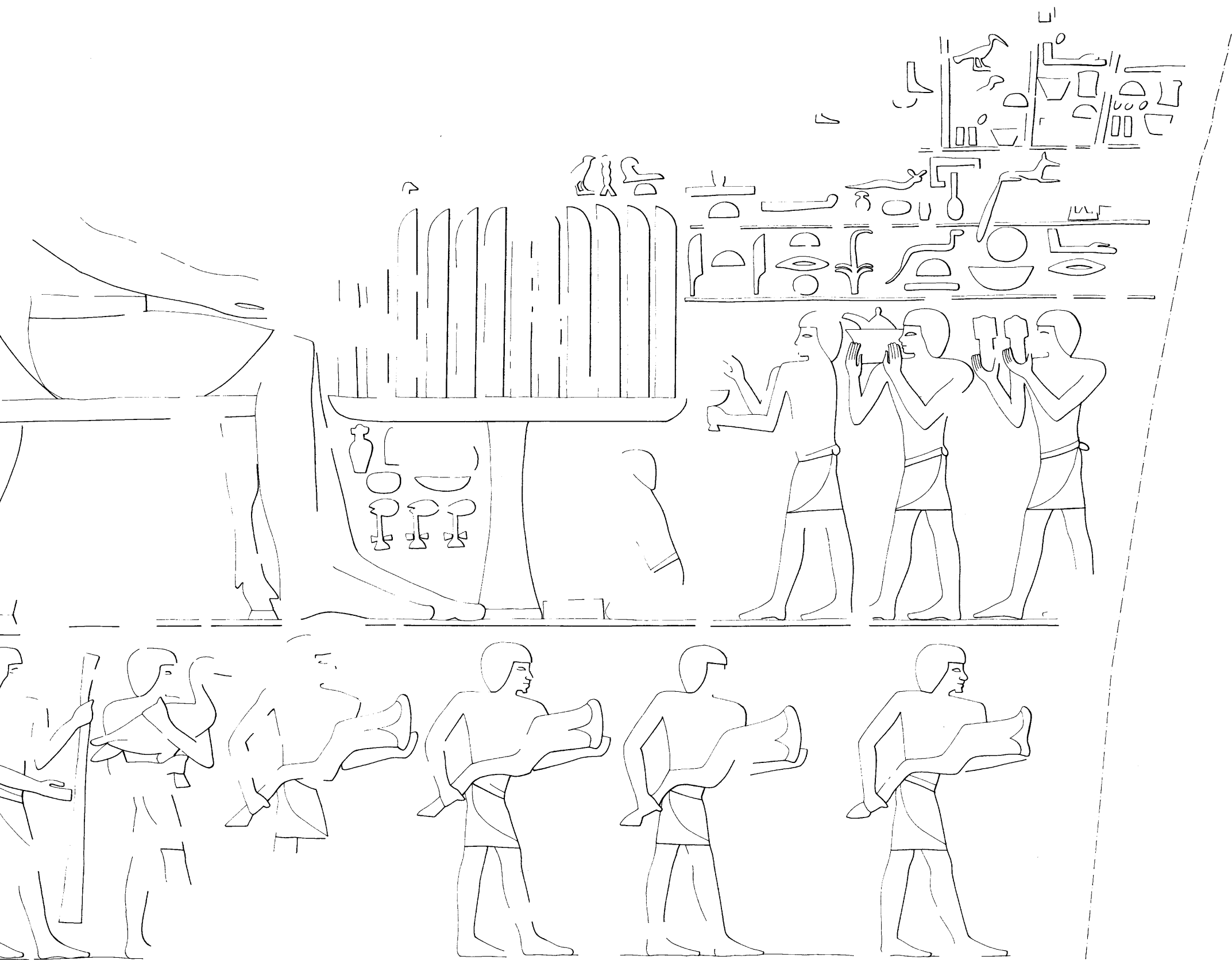

6030: South wall, texts (3.4-3.8)

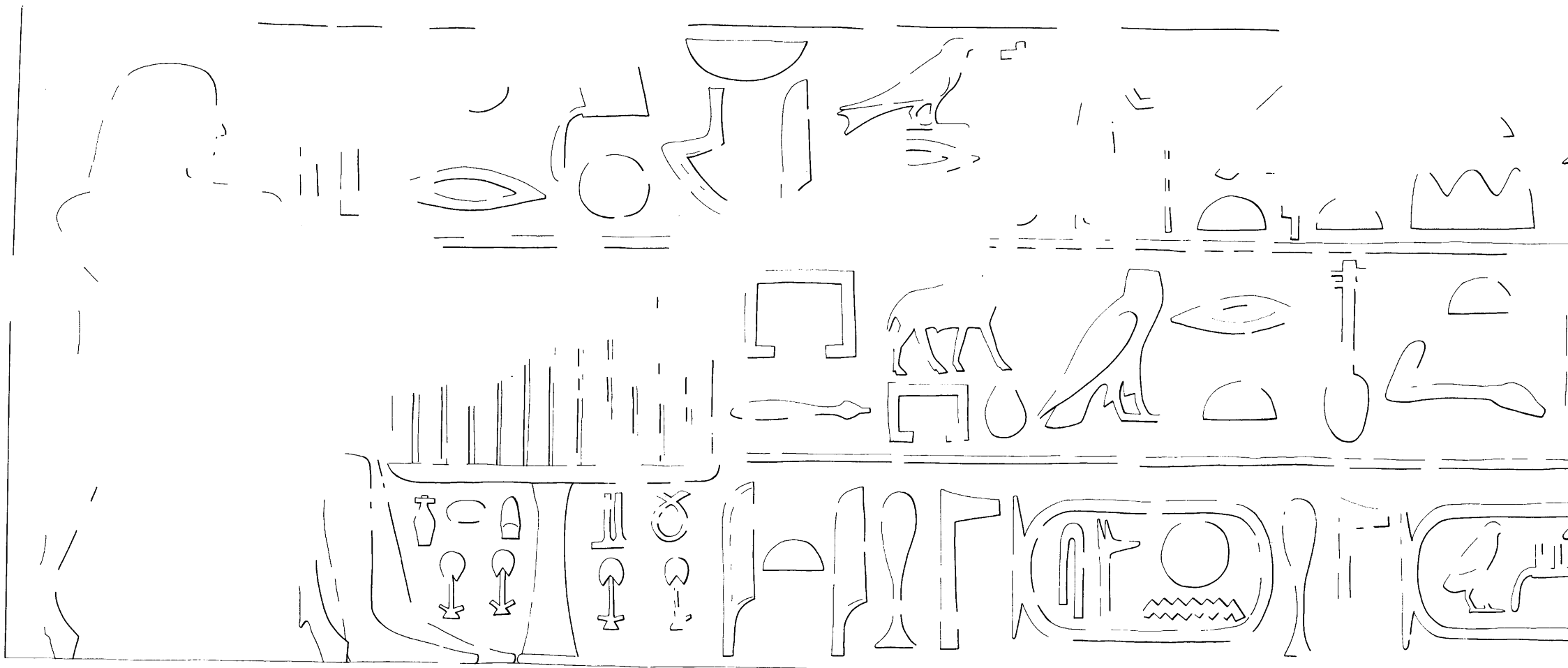

52. G 6030: Architrave, texts {3.9-3.10}

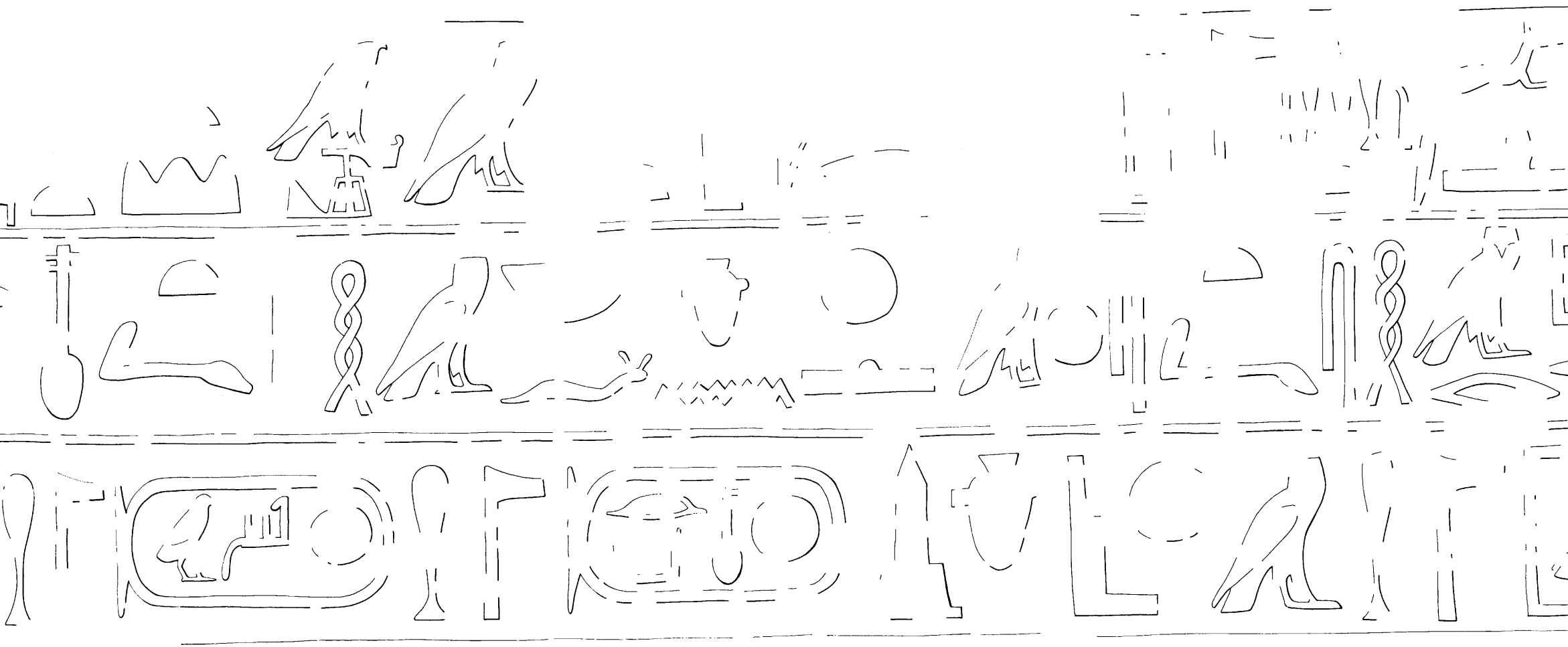

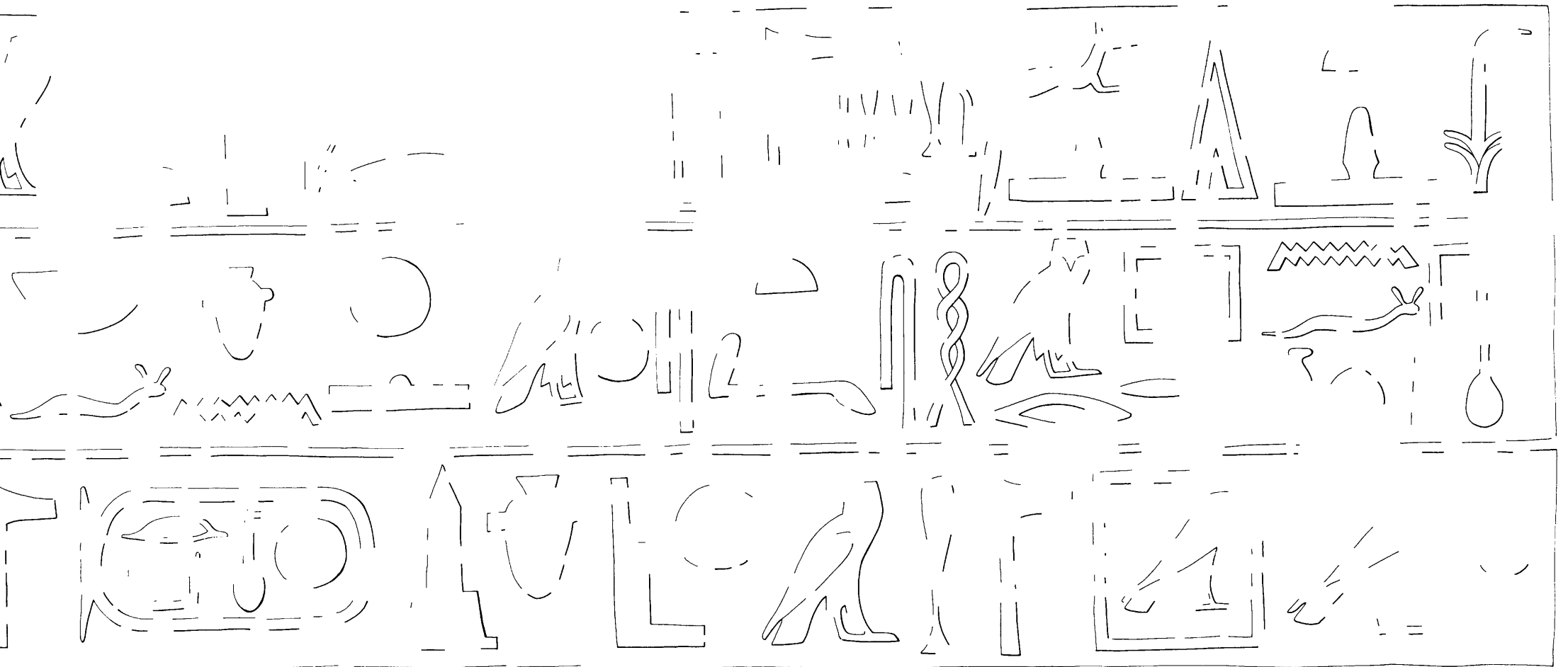

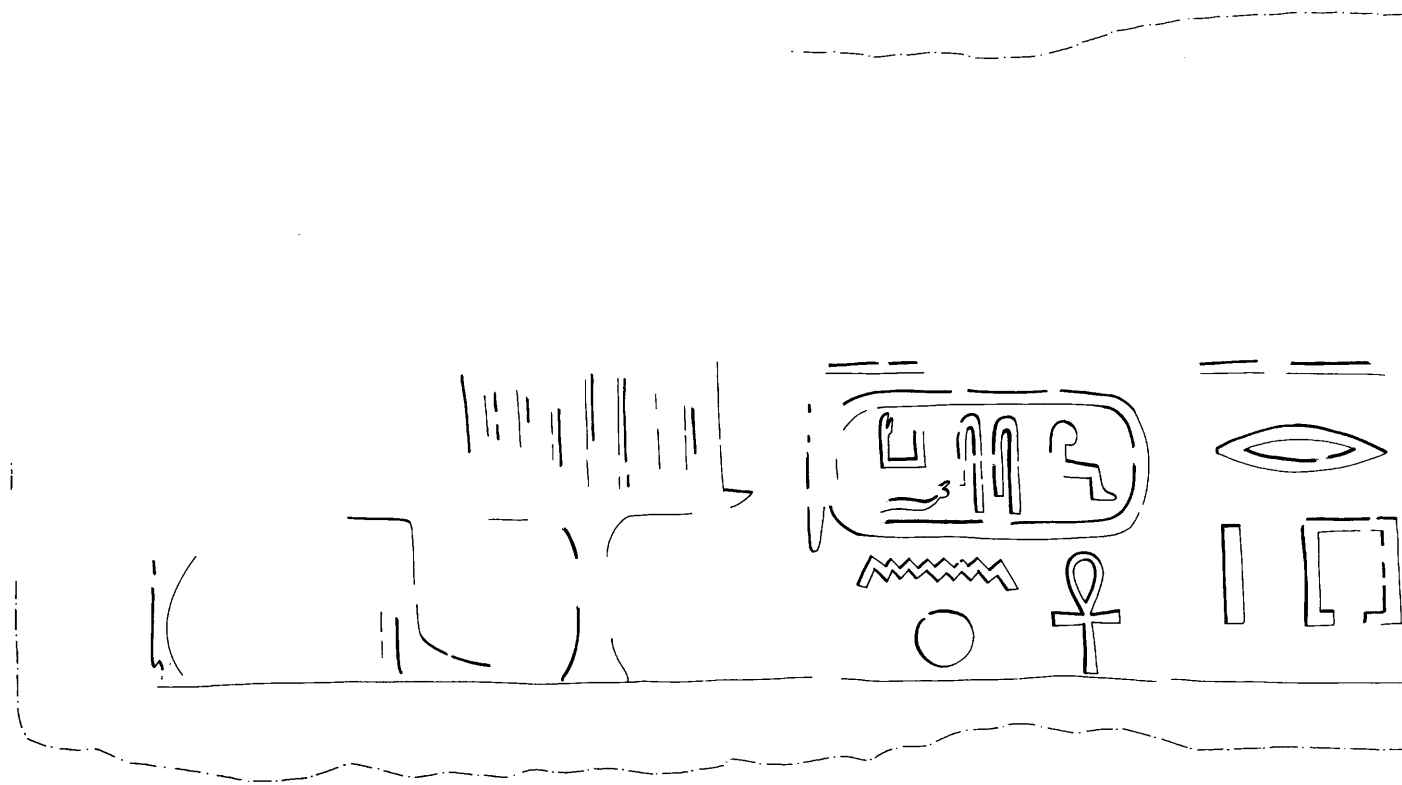

53. G 6040: First chamber, lintel above false door, text [4.1]

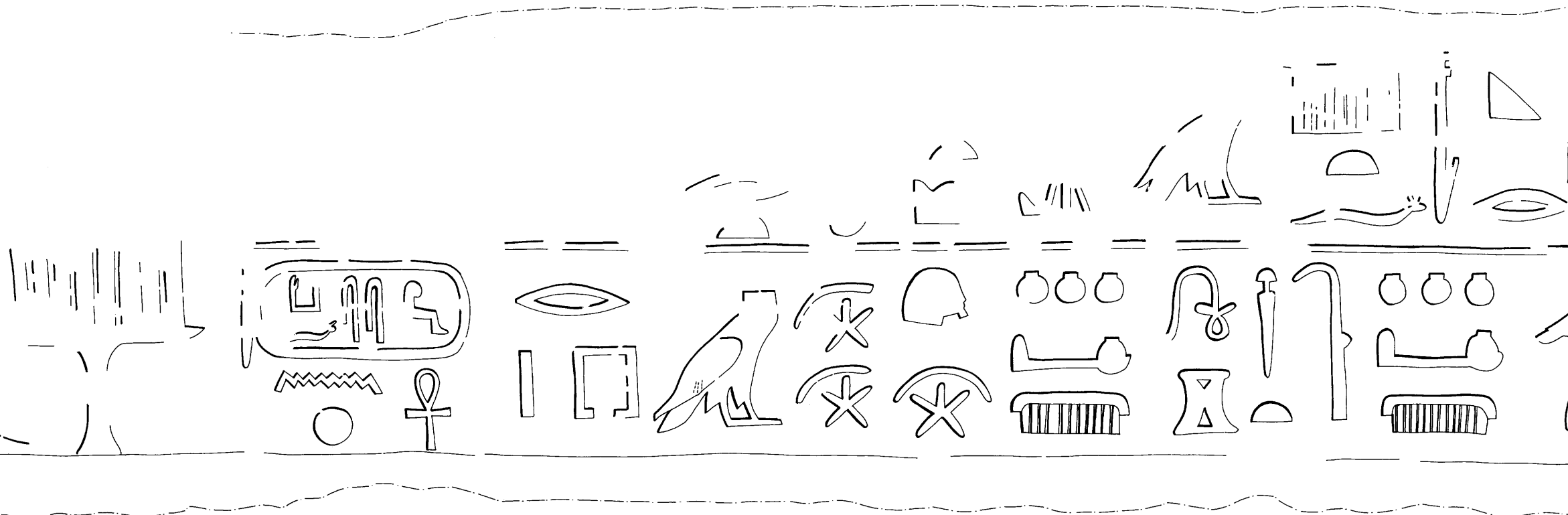

alse door, text {4.1}

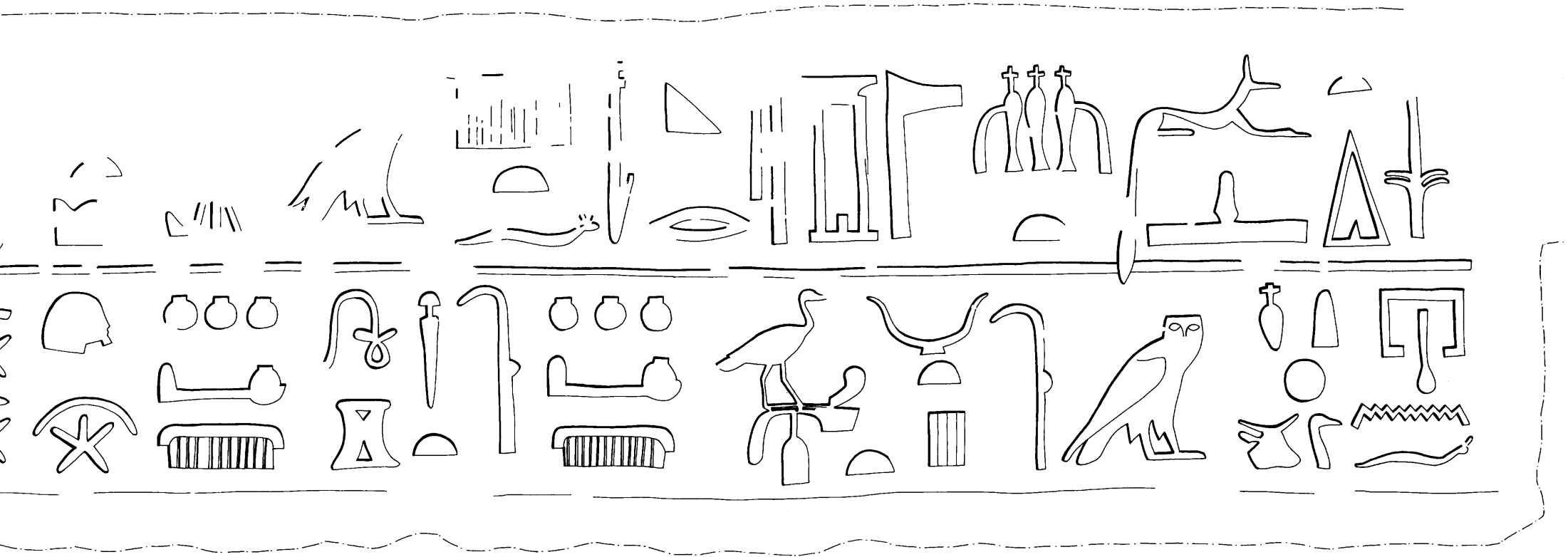

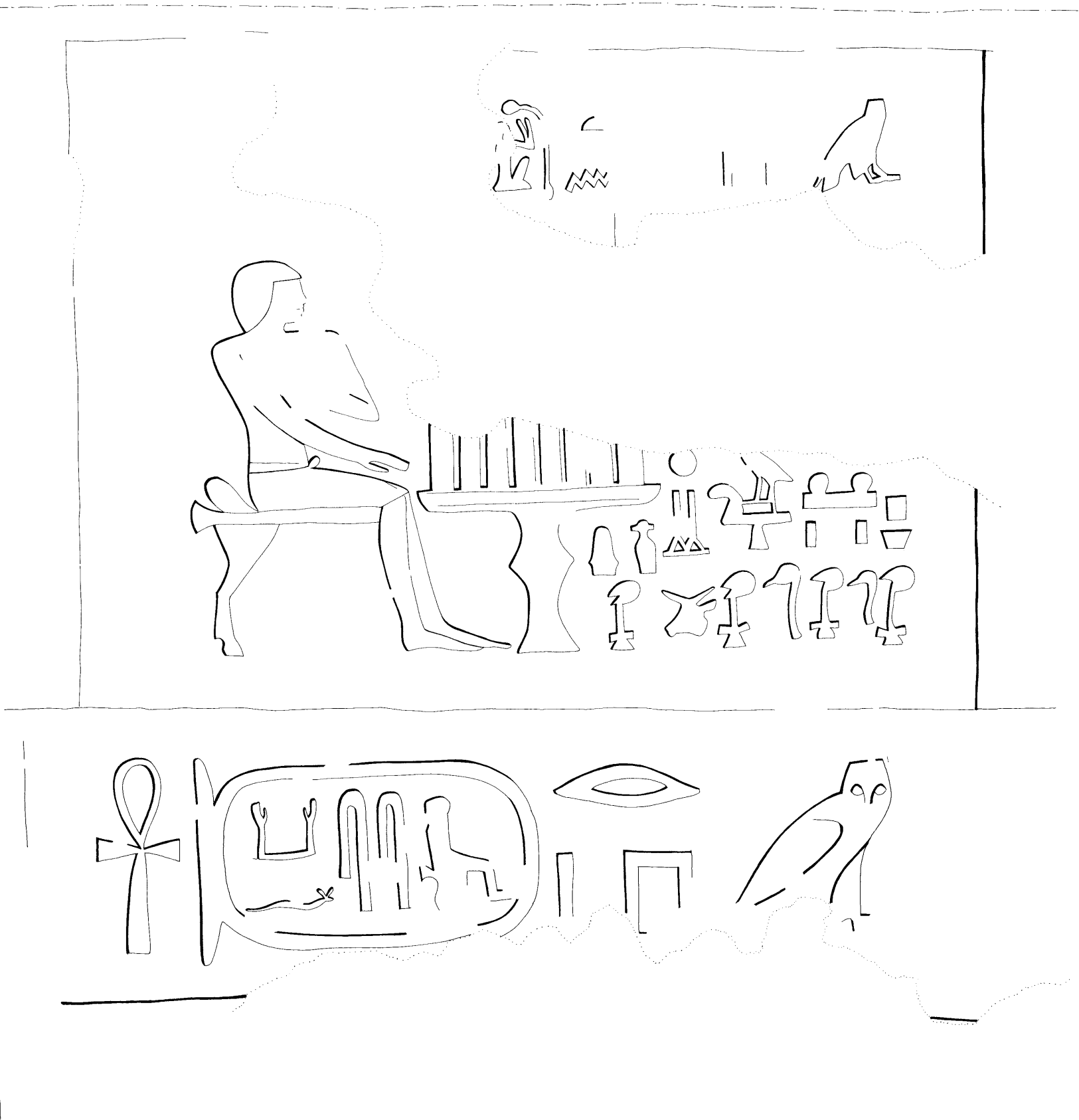

54. G 6040: First chamber, drum and stela above doorway, texts {4.2-4.5}

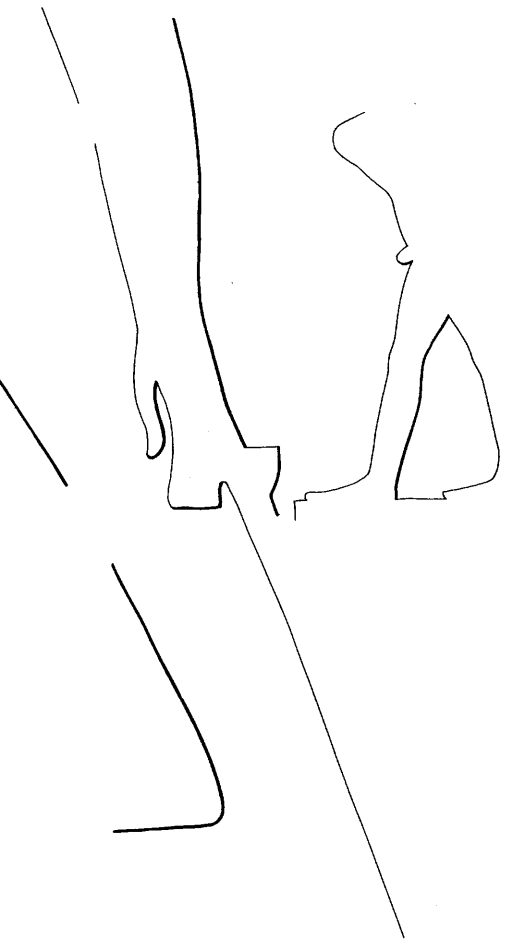
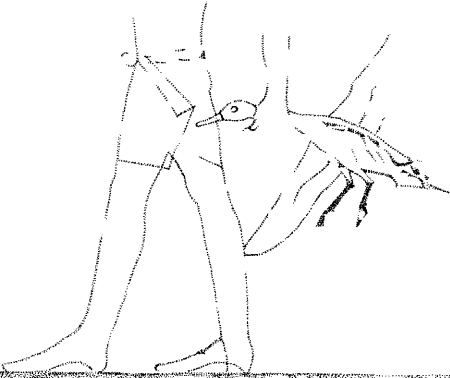
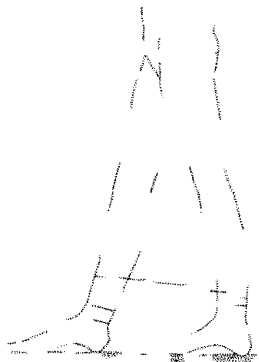
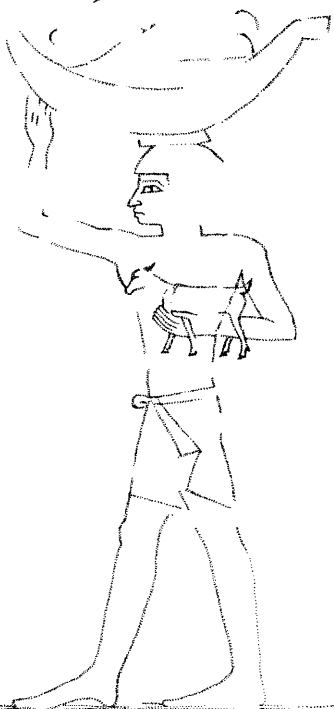
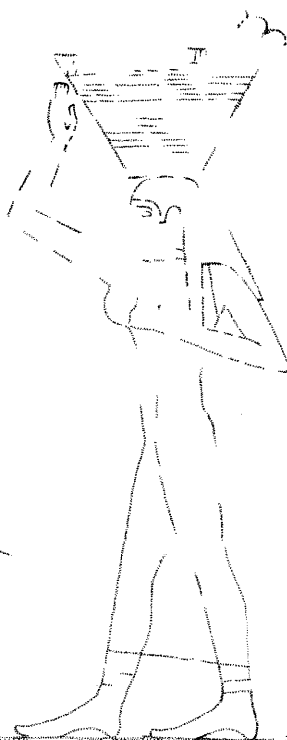
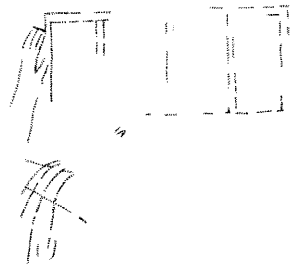
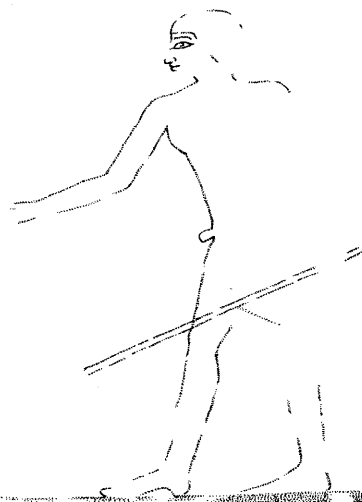

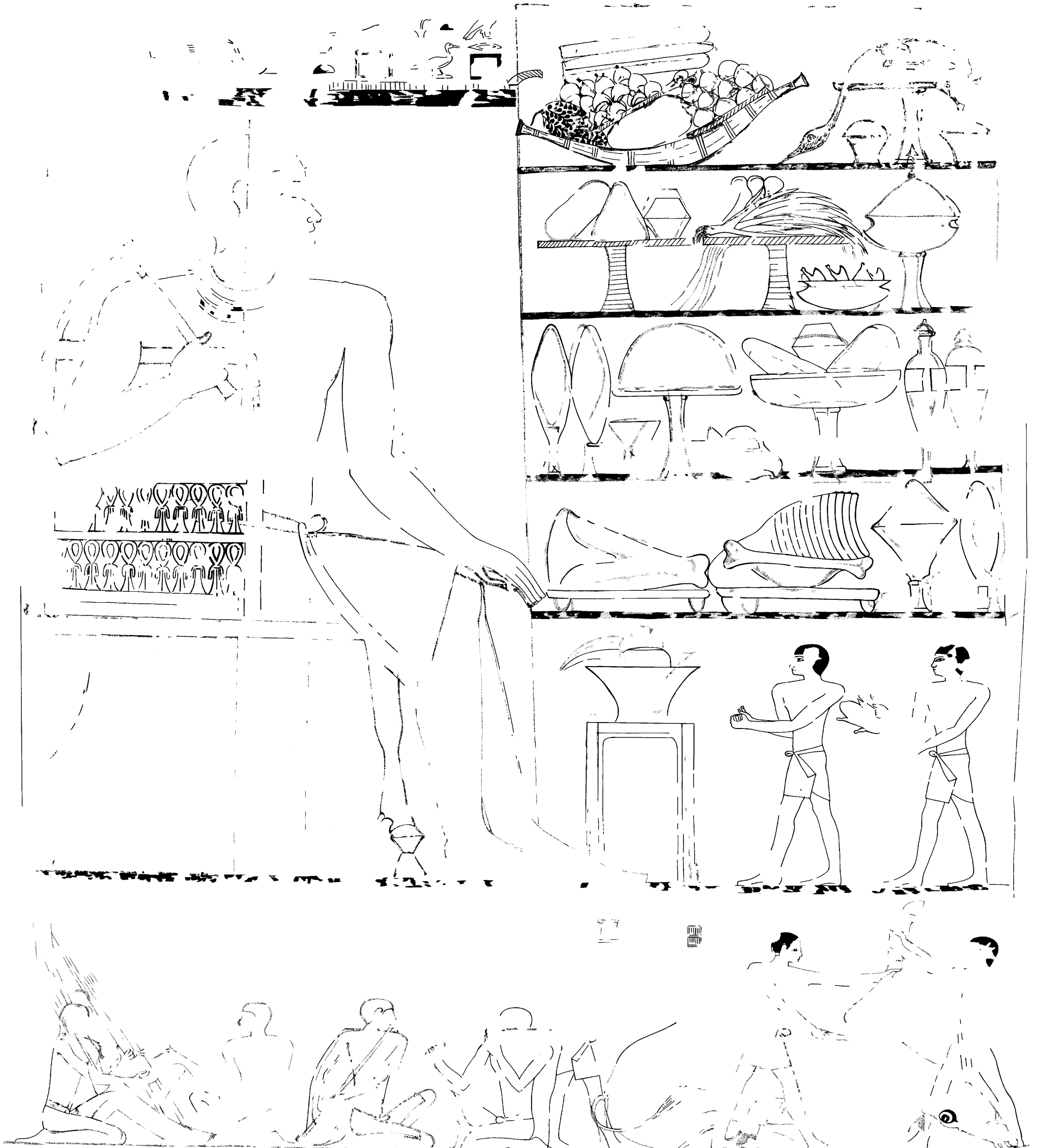

56. G 6040: Second chamber, south wall, texts {4.6-4.7}

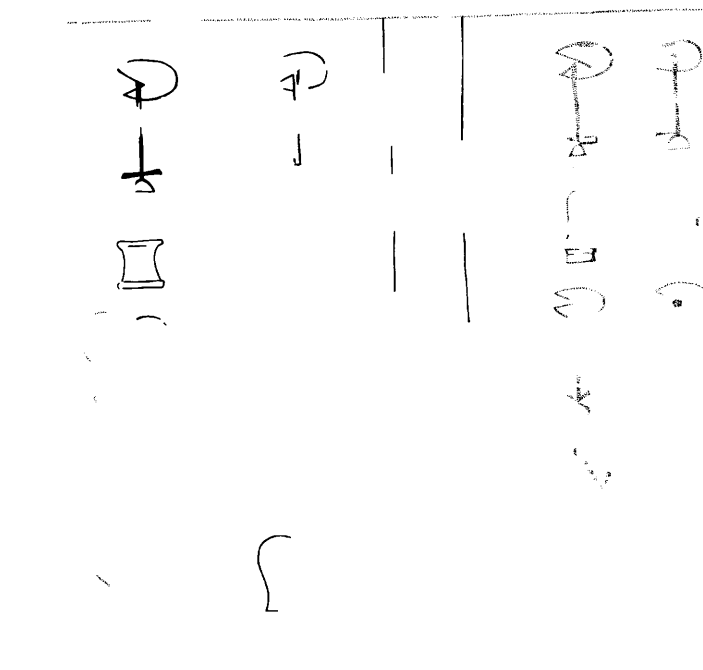
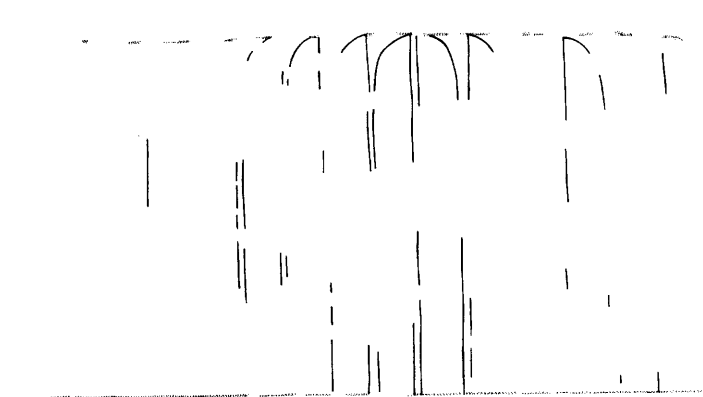
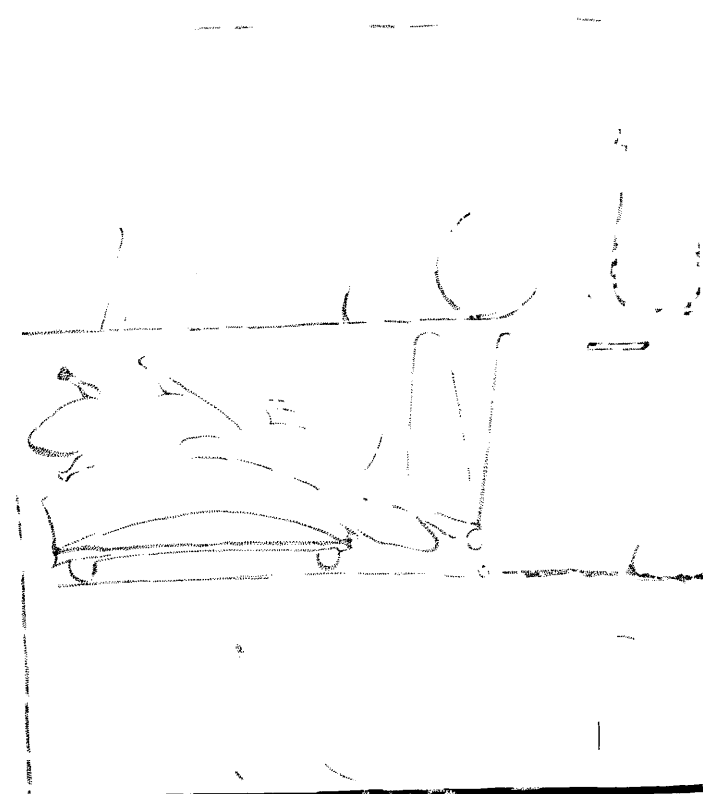
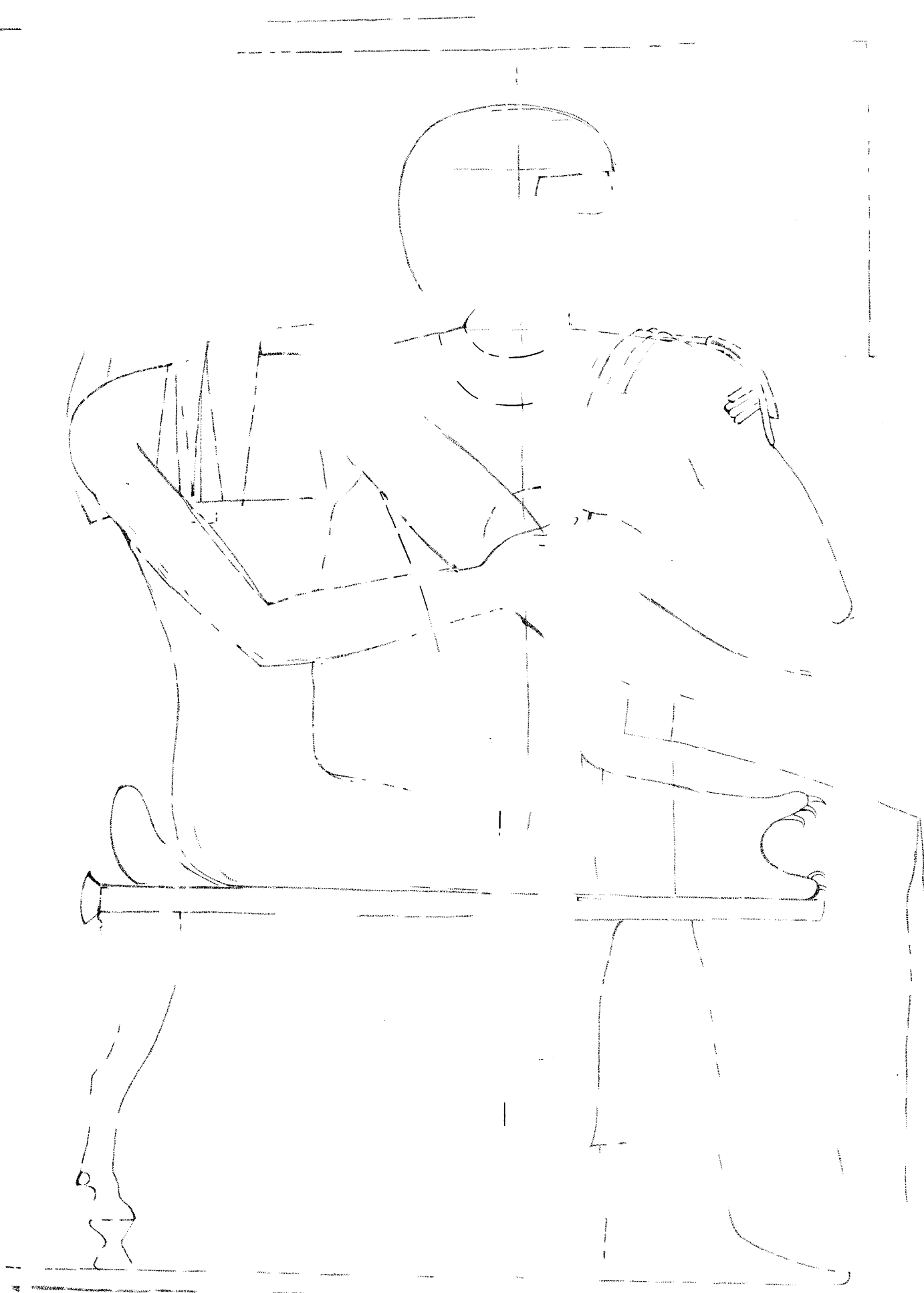

57. G 6040: Second chamber, west wall, text [4.8]



58. G 6010, shaft A: East-west section looking south

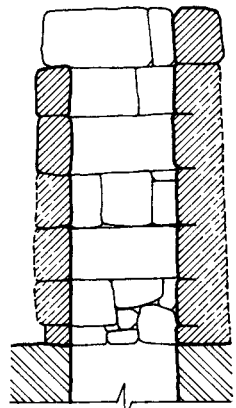
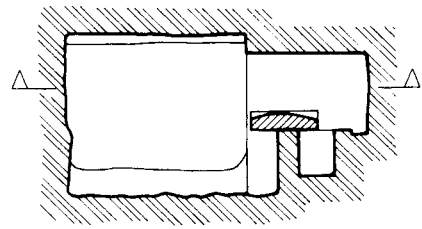

59. G 6010, shaft A: Plan of shaft and chamber

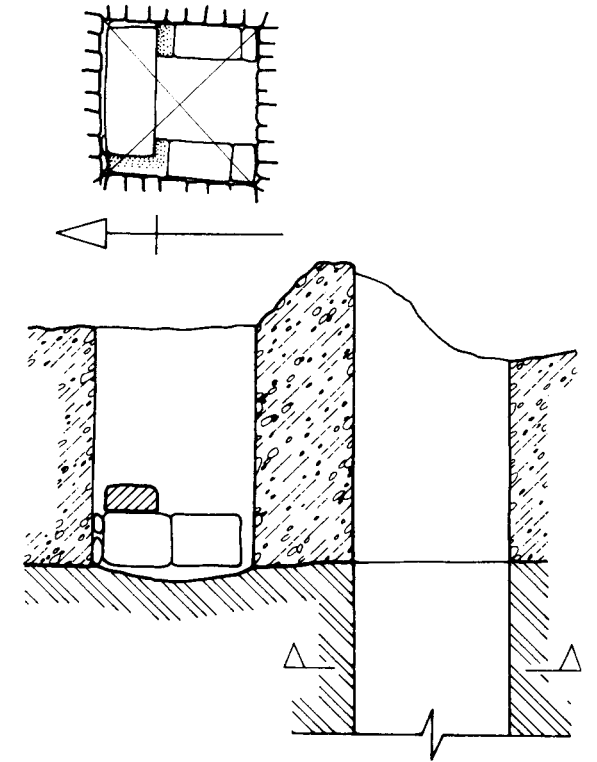
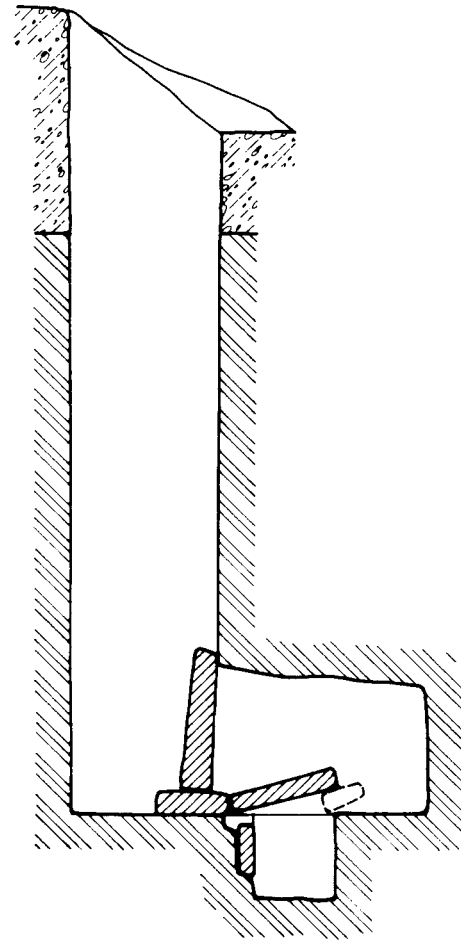
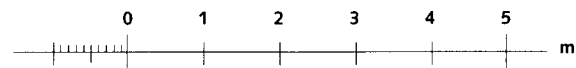
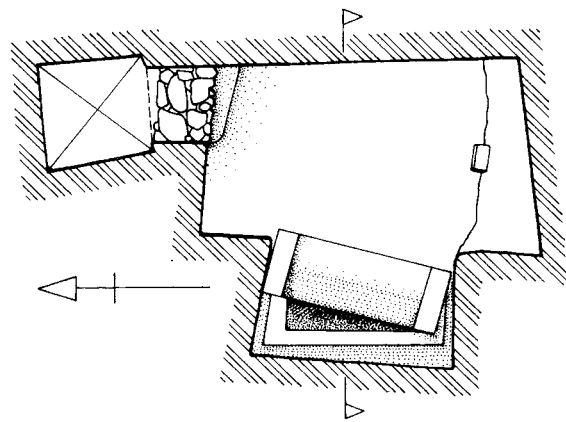
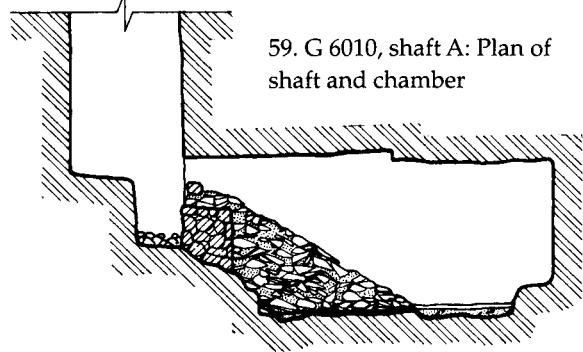

60. G 6012, shafts A and B: Plans and sections

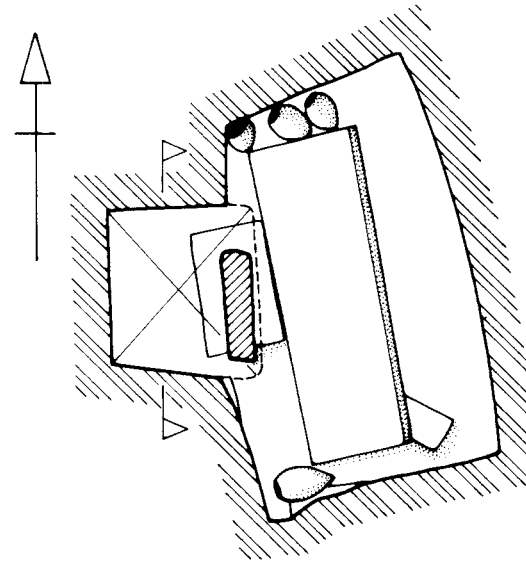

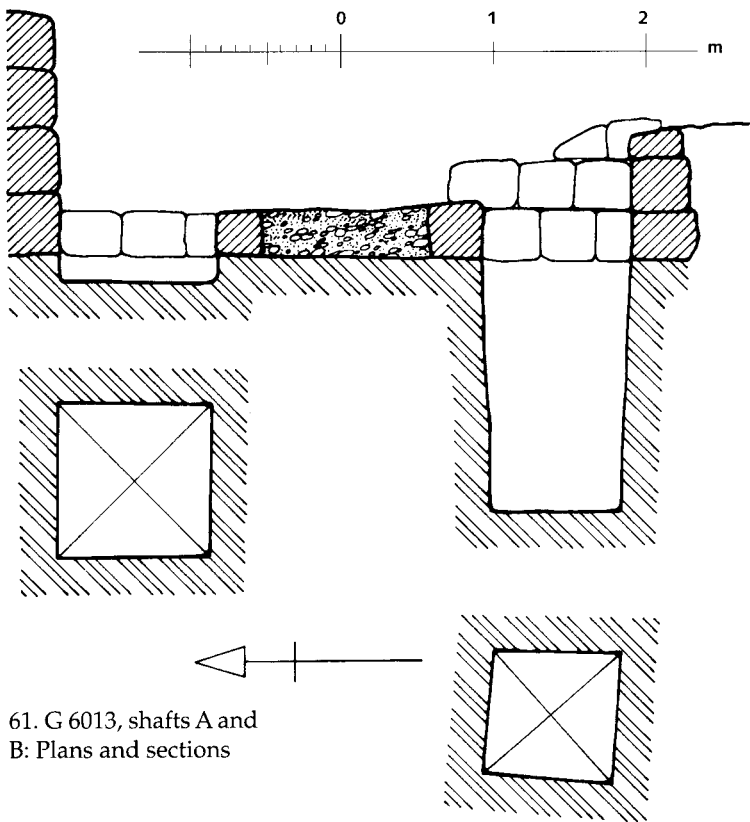

61. G 6013, shafts A and B: Plans and sections

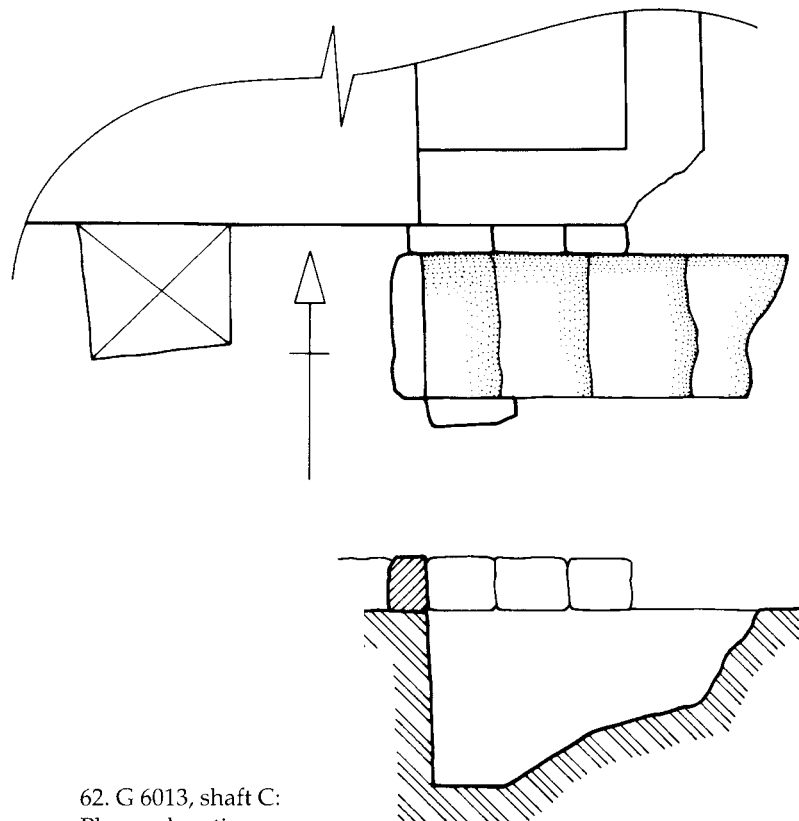

62. G 6013, shaft C: Plan and section

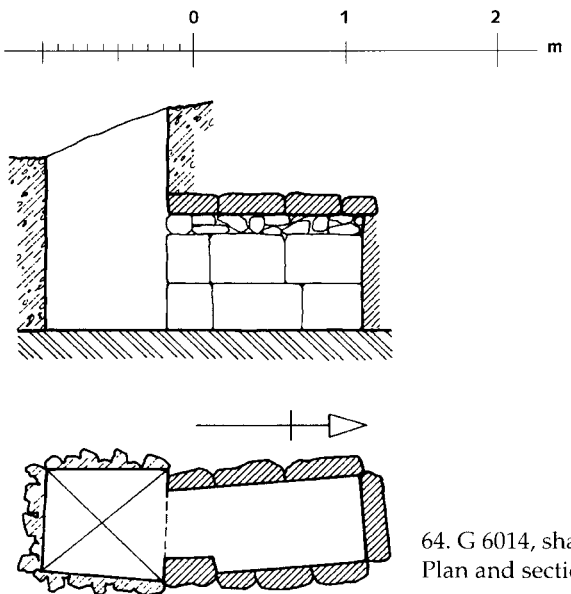
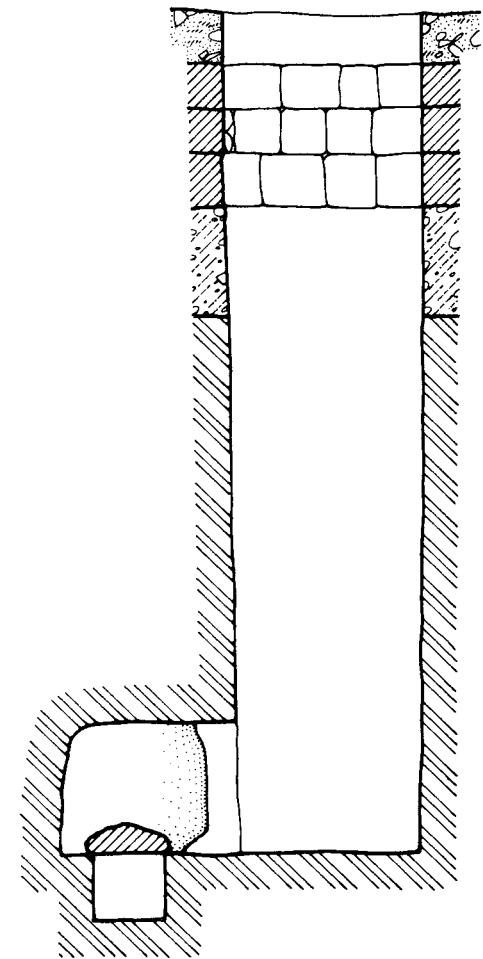

64. G 6014, shaft C: Plan and section

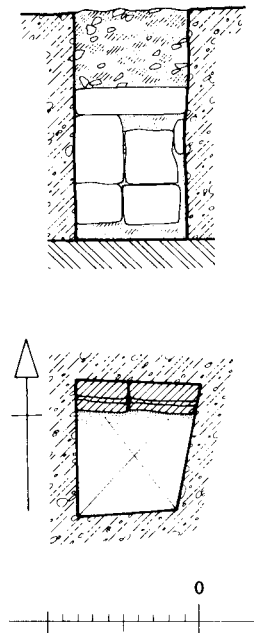

65. G 6014, shaft C: Plan and section of burial

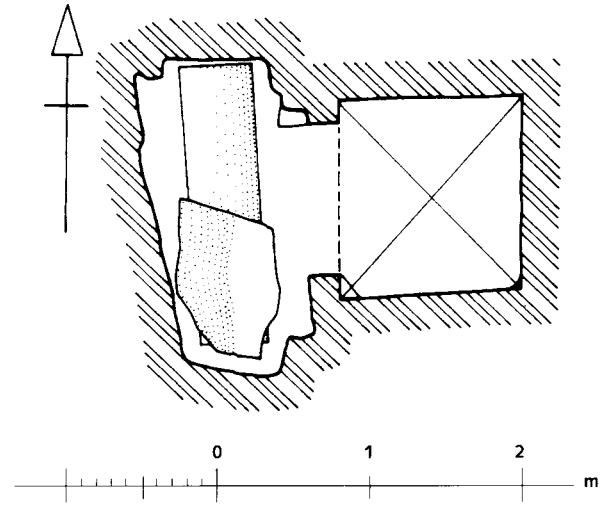

63. G 6014, shaft A: Plan and section

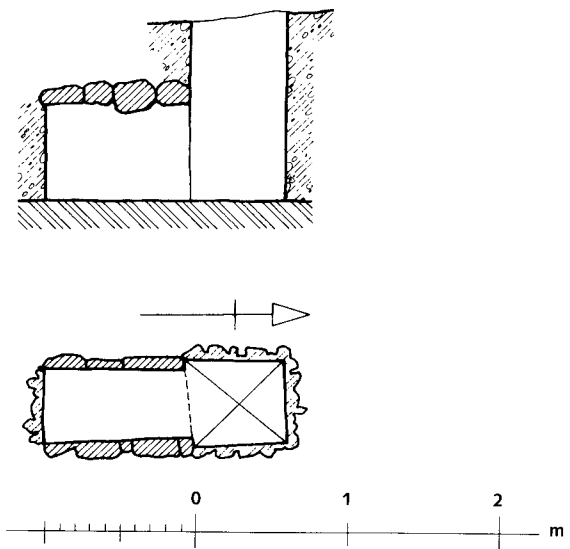

66. G 6014, shaft E: Elevation

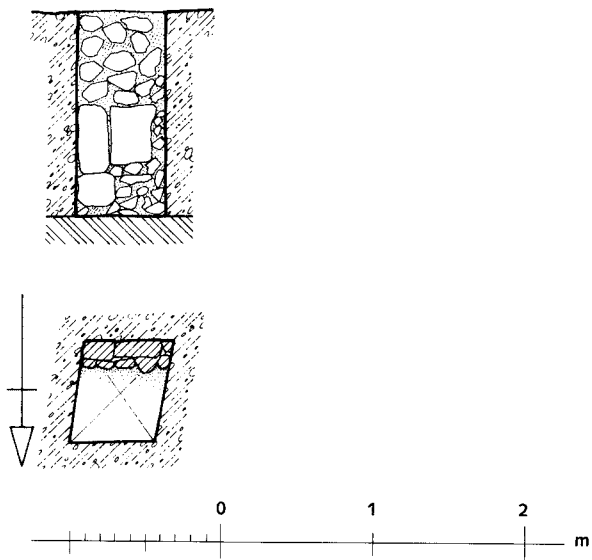

67. G 6014, shaft E:
Plan and section

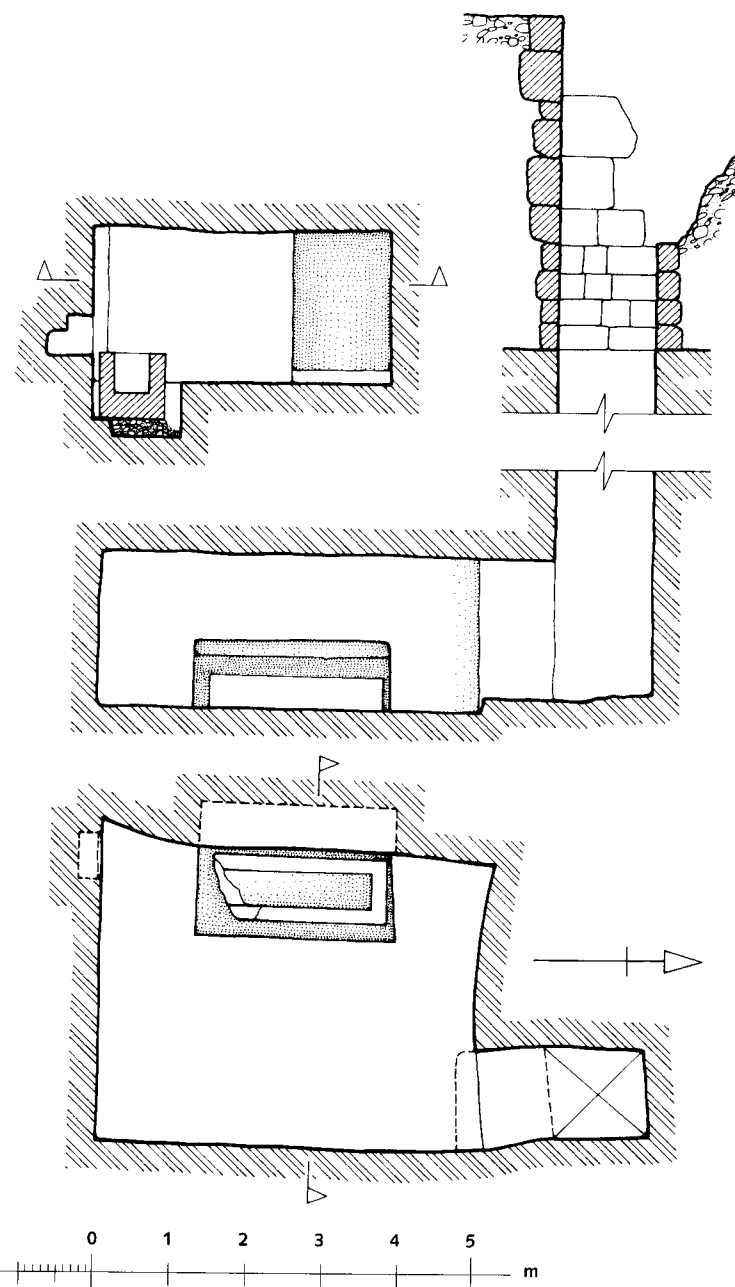

68. G 6020, shaft A: Plan and sections

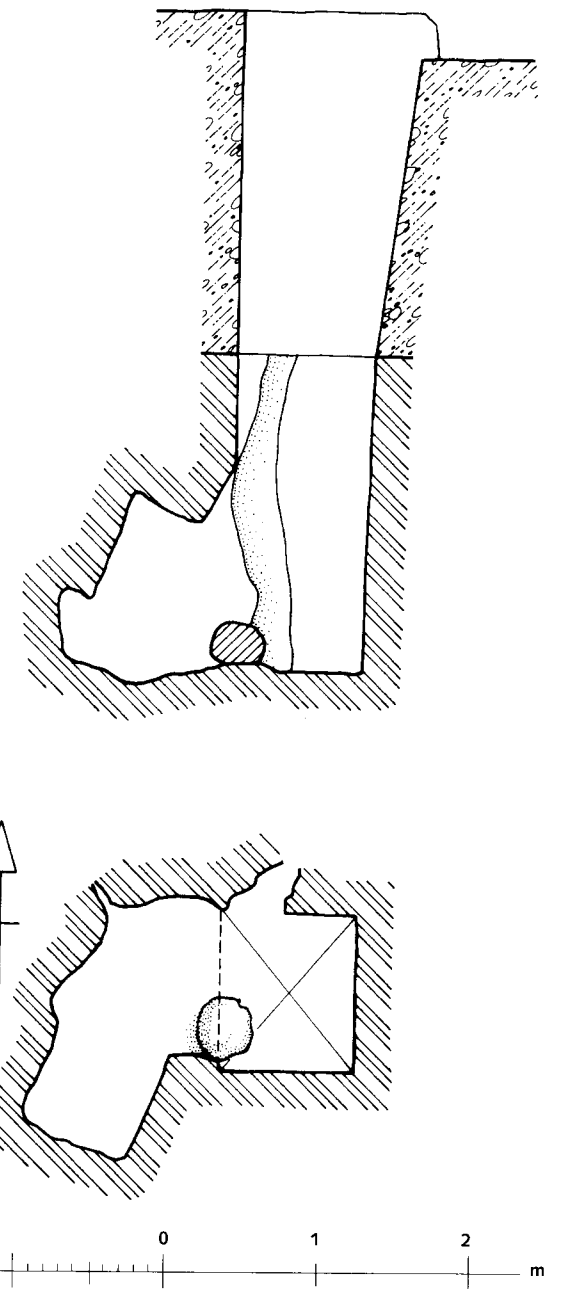

69. G 6021, shaft A: Plan and section

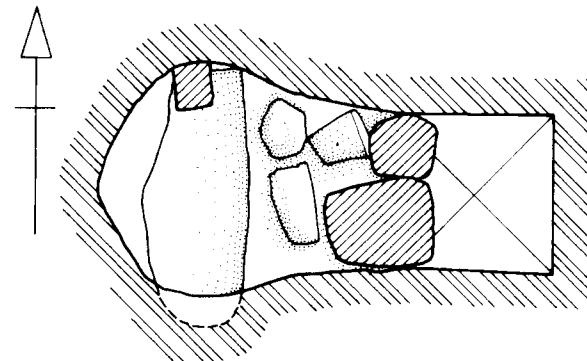
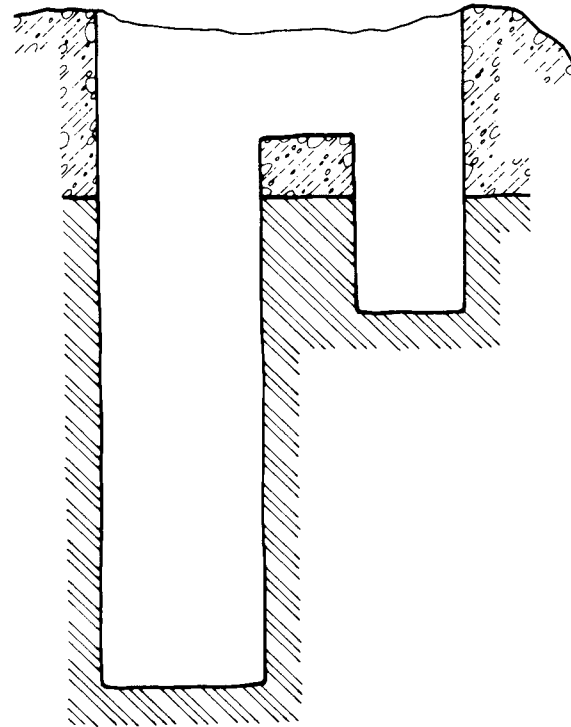
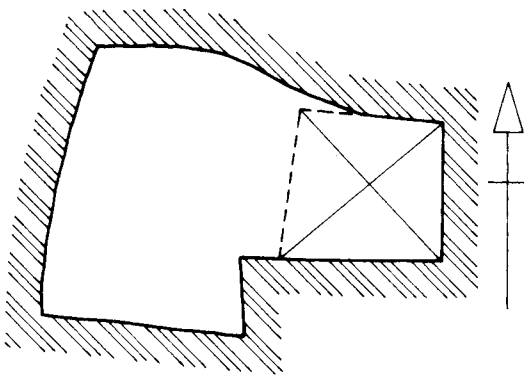
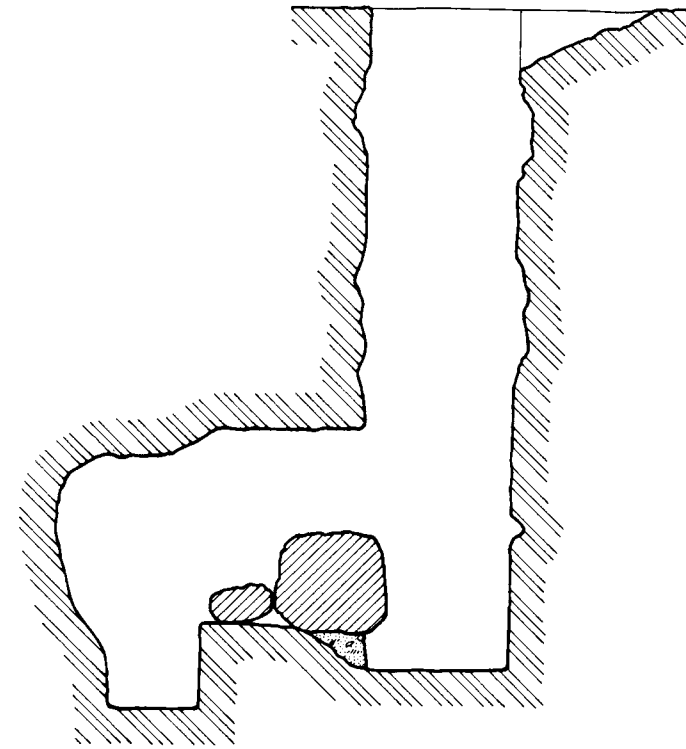
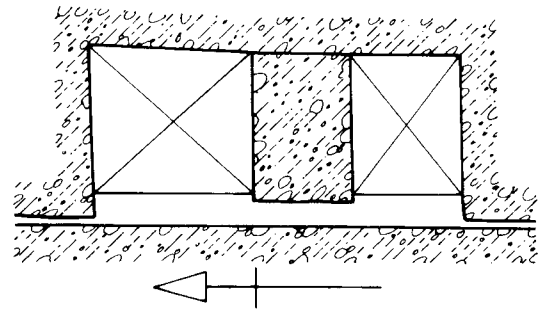
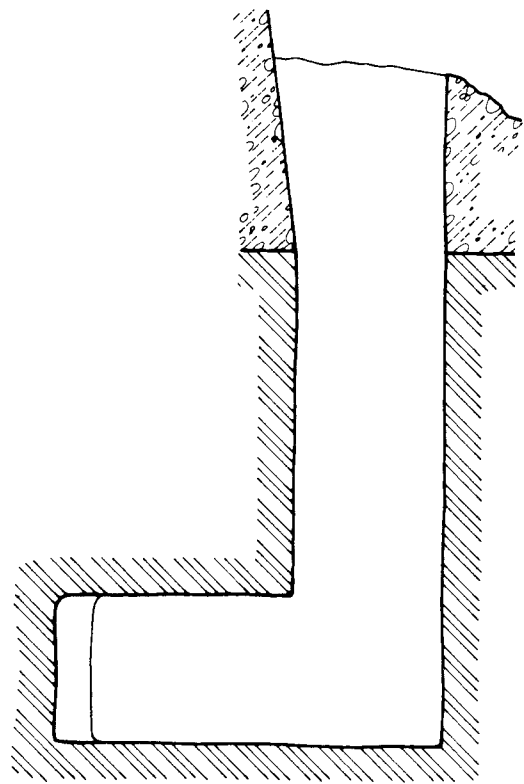

70. G 6022, shaft A: Plan and section

71. G 6022, shaft B: Plan and section

72. G 6023, shaft A: Plan and section

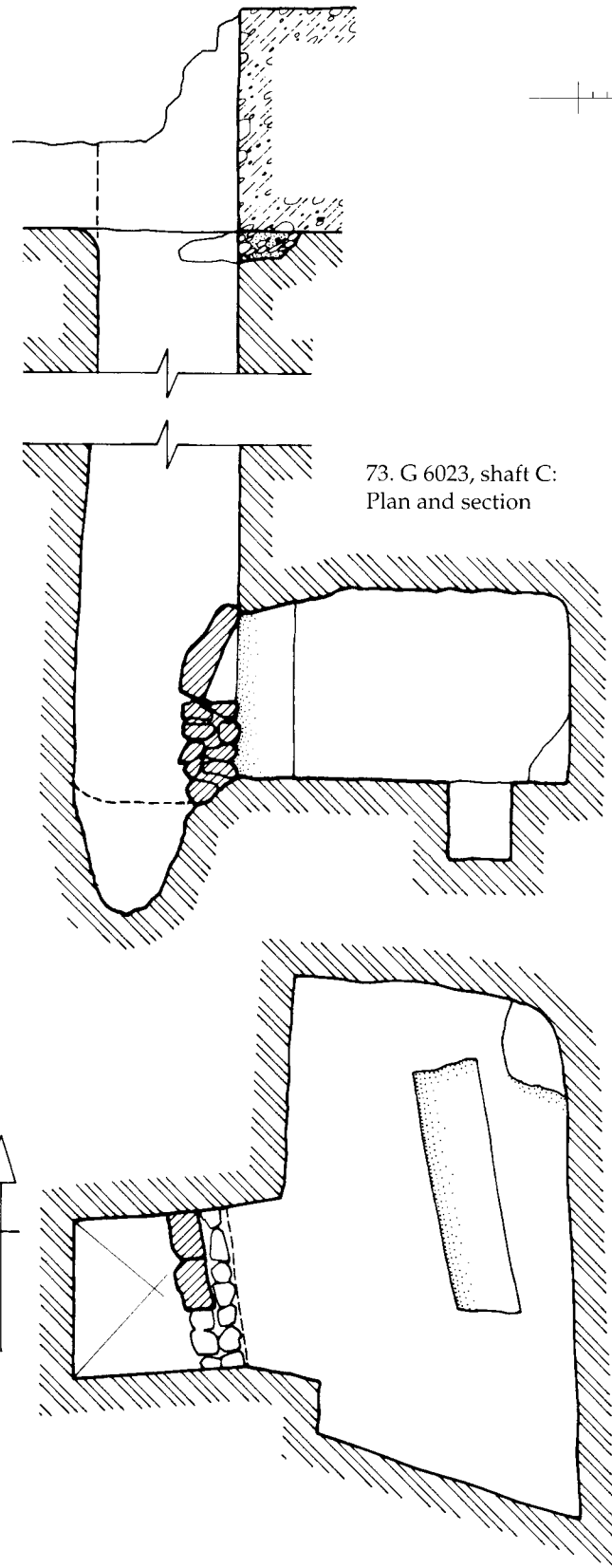

73. G 6023, shaft C:
Plan and section

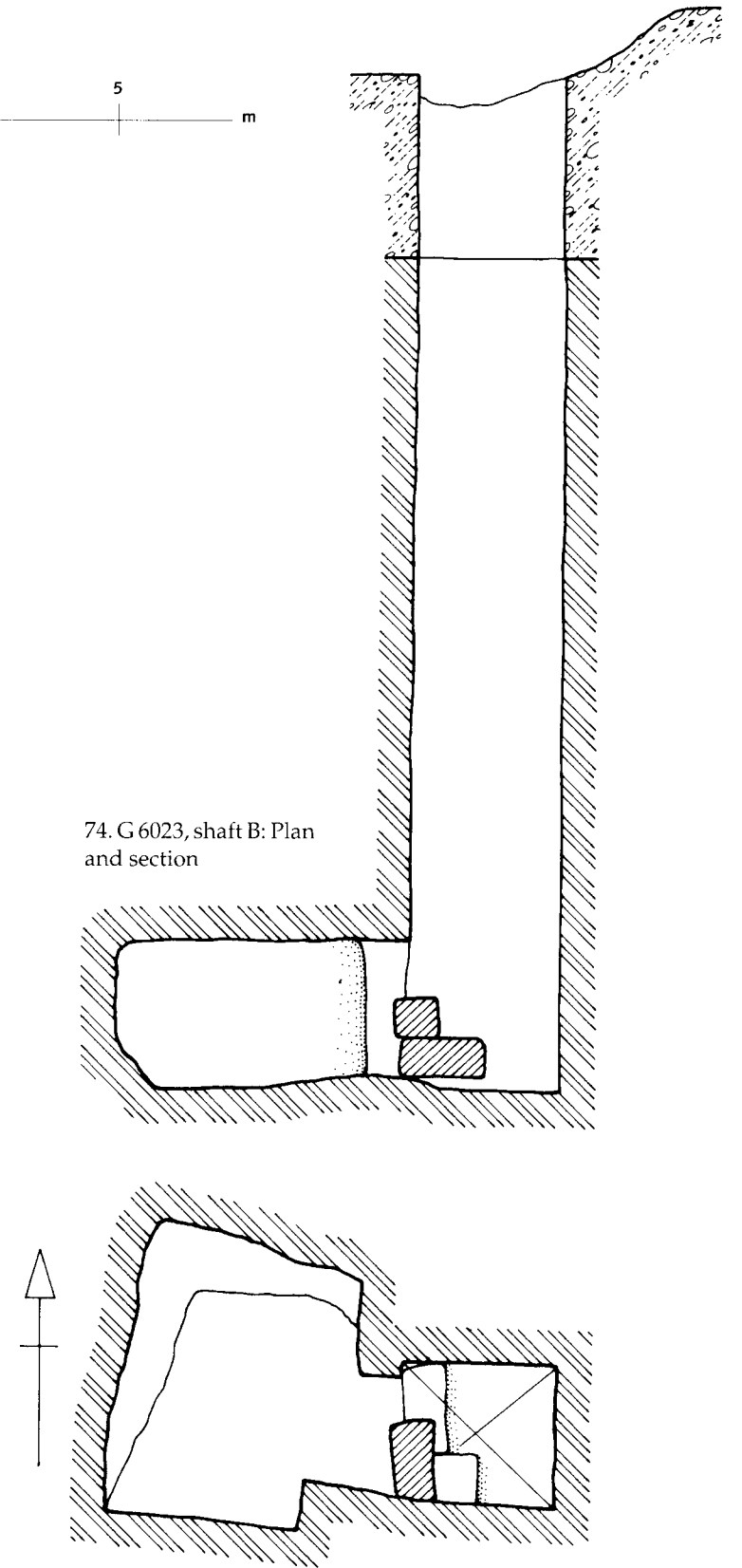
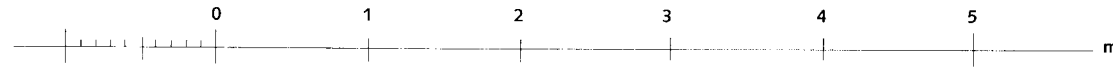

74. G 6023, shaft B: Plan
and section

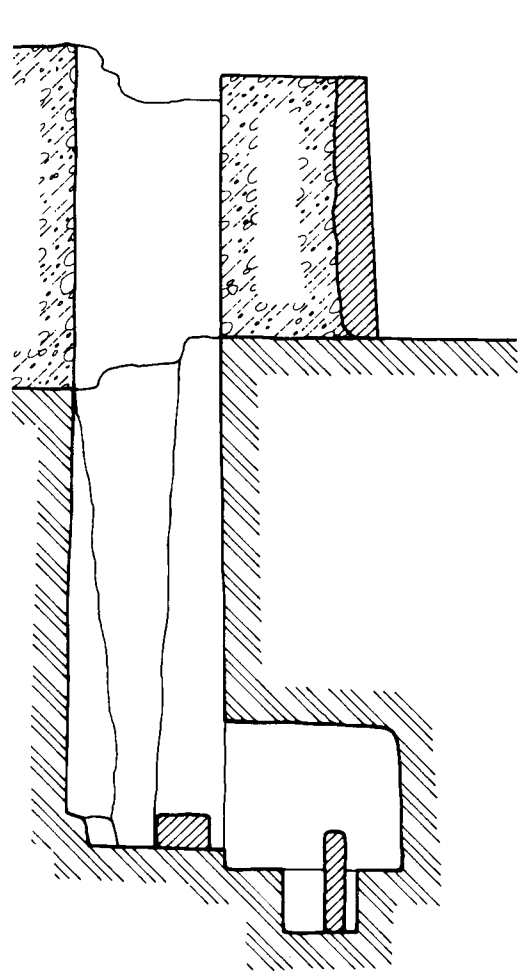

75. G 6028, shaft F: Plan and section

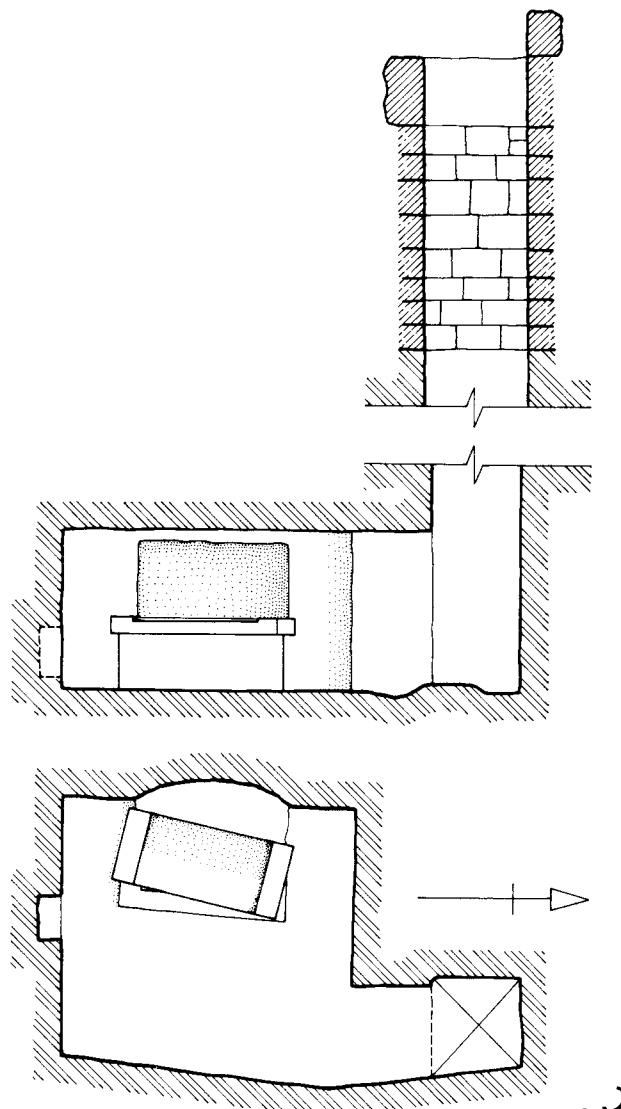

76. G 6030, shaft A: Plan and section

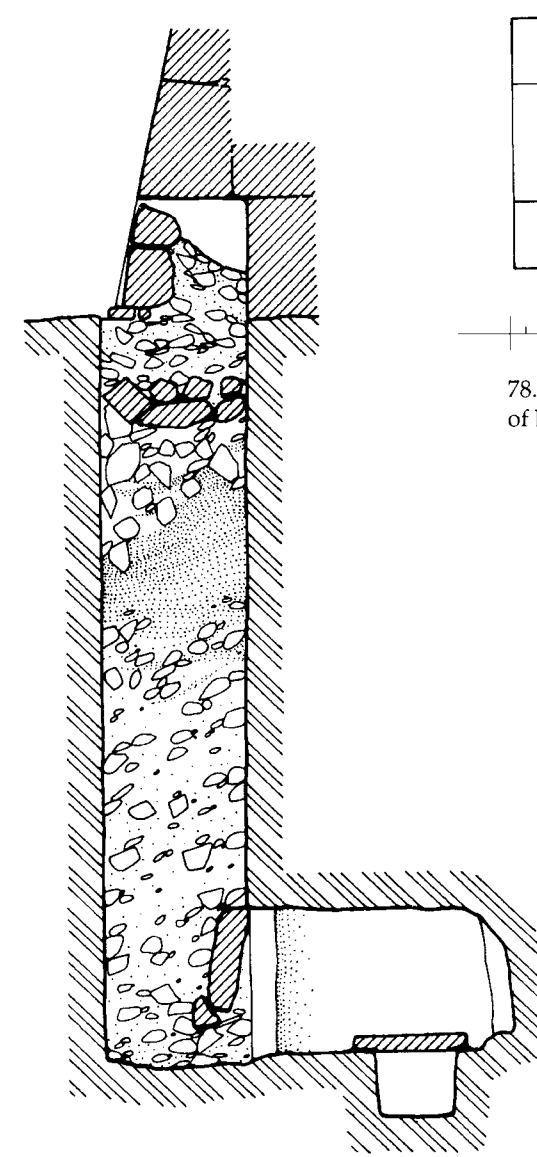

77. G 6030, shaft B: Section

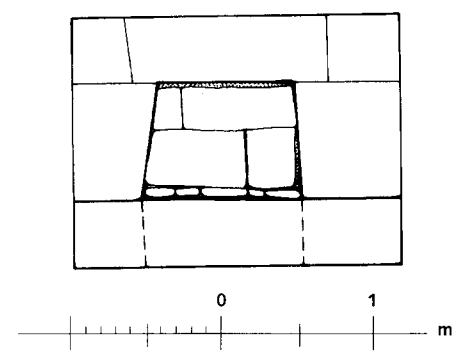

78. G 6030, shaft B: Blocking of burial chamber

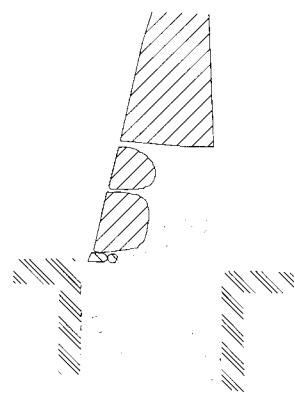

79. G 6030, shaft B: East-west section of burial chamber

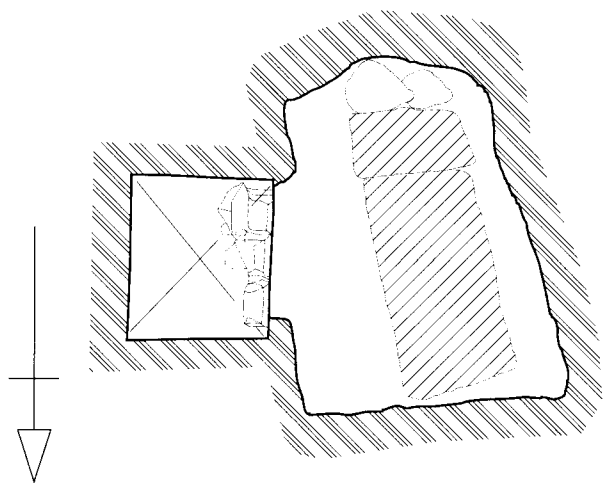

80. G 6030, shaft B: Plan

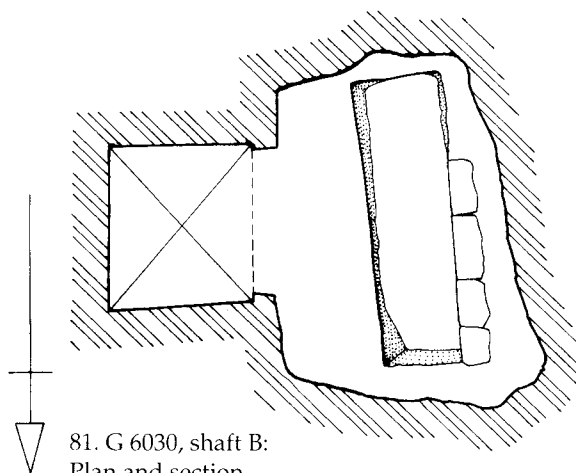
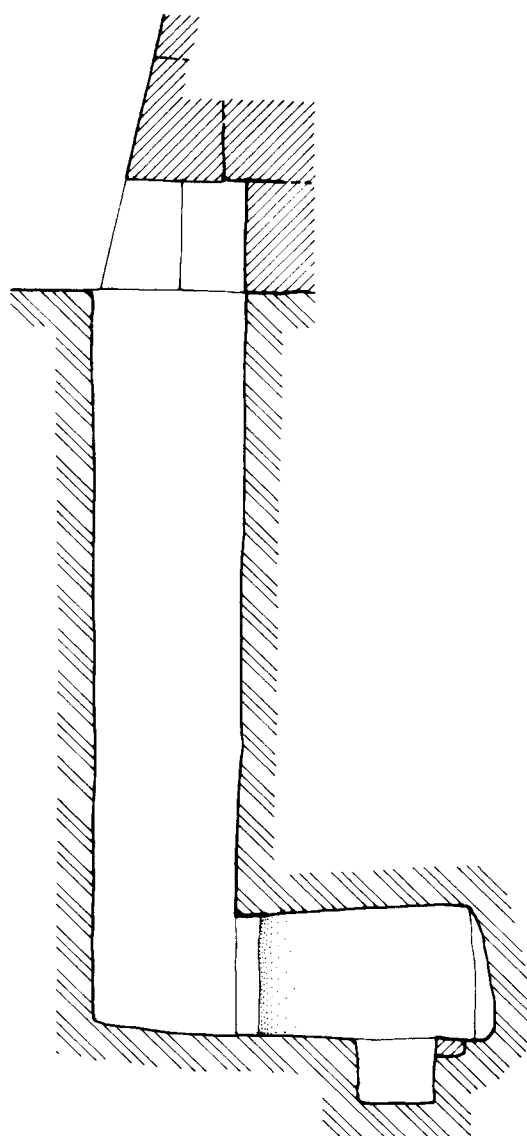

81. G 6030, shaft B:
Plan and section

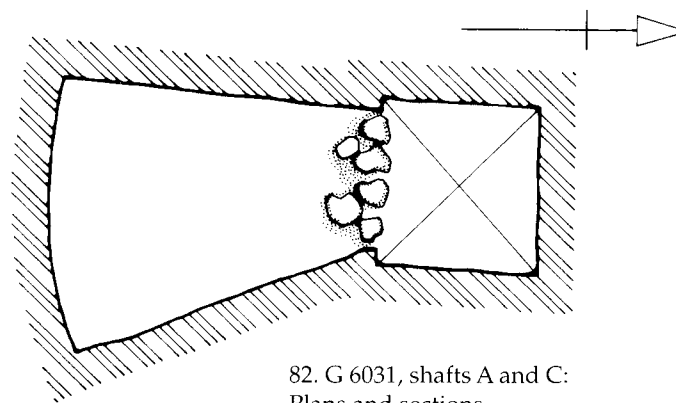
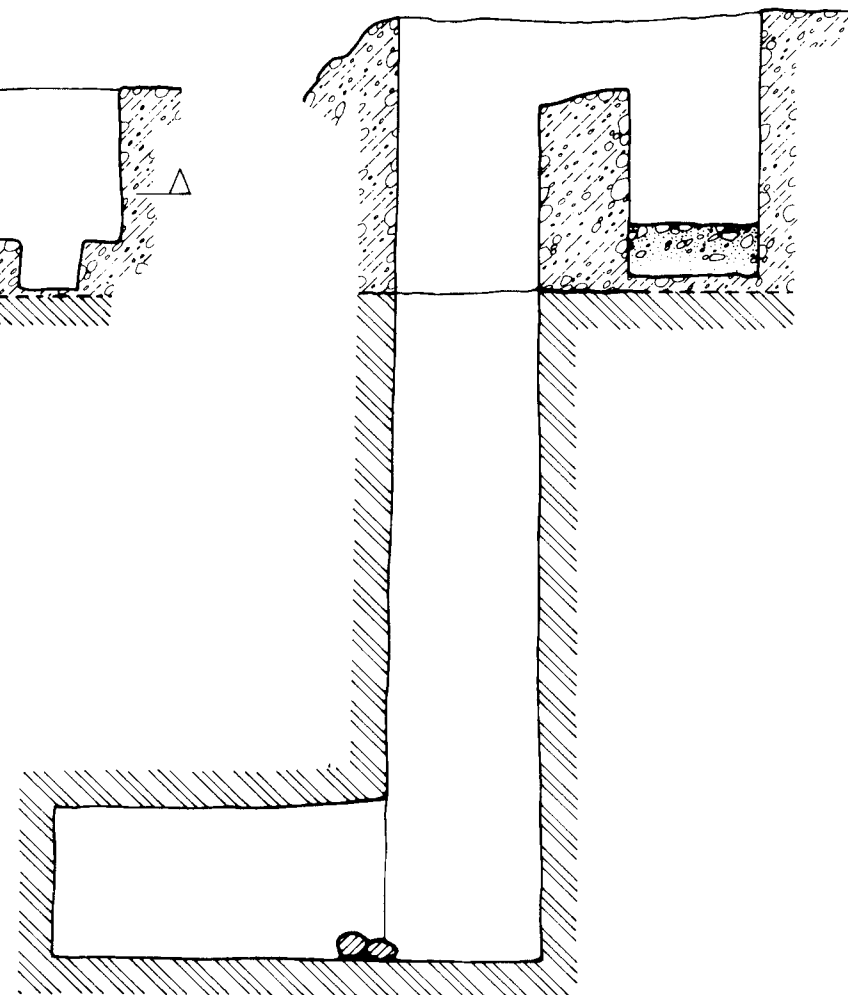
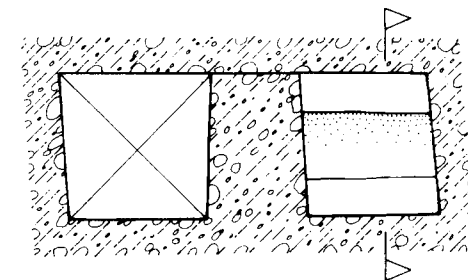
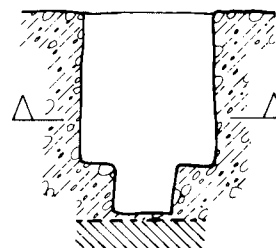

82. G 6031, shafts A and C:
Plans and sections

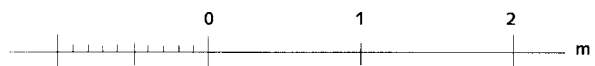

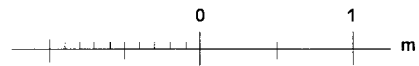
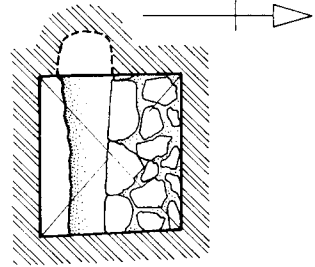
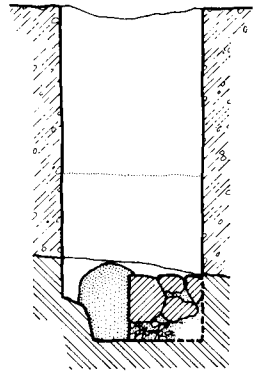

83. G 6031, shaft B: Plan and section

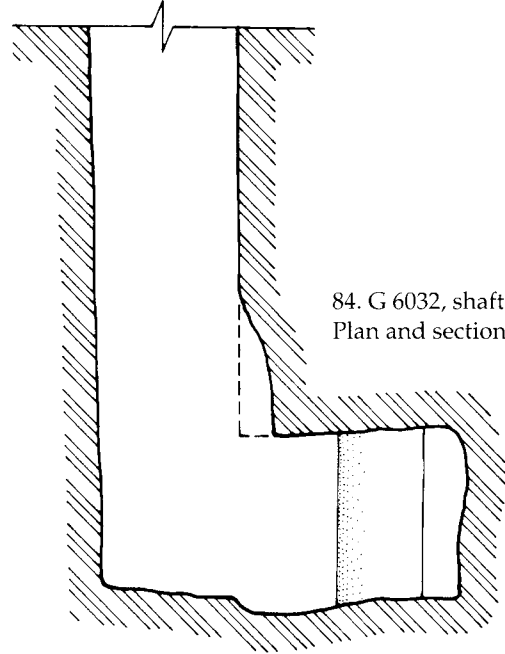
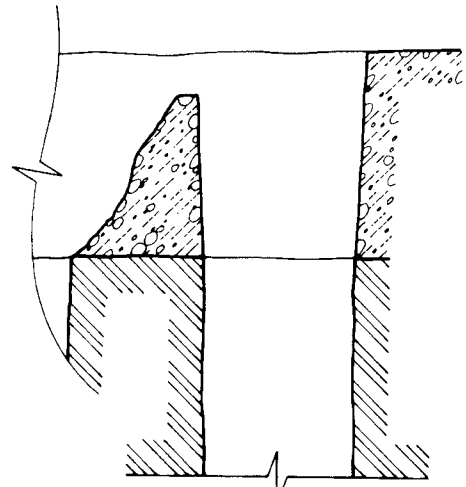

84. G 6032, shaft A:
Plan and section

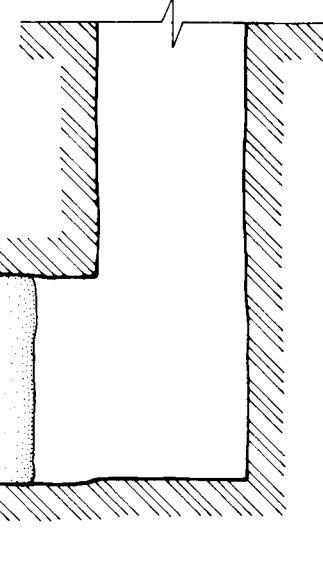
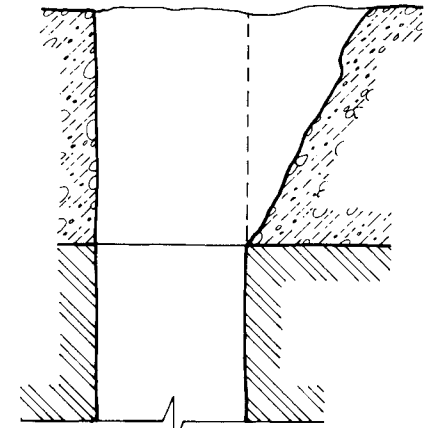
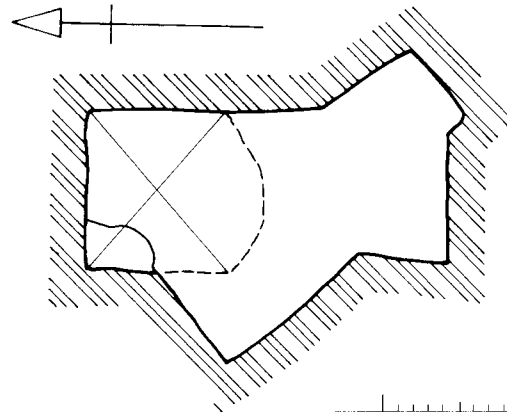

85. G 6032, shaft B: Plan
and section

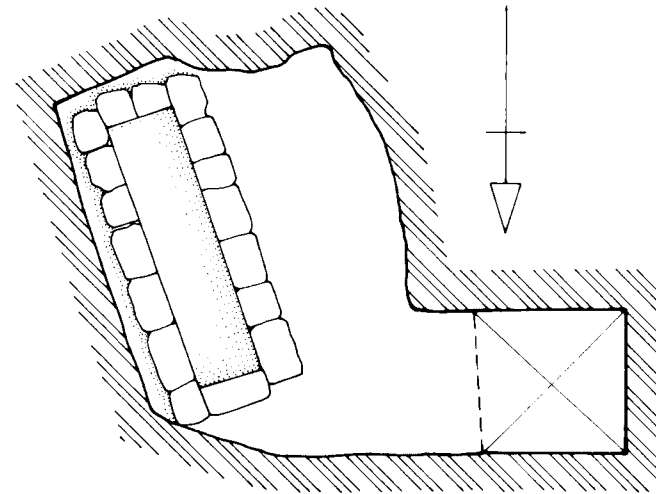

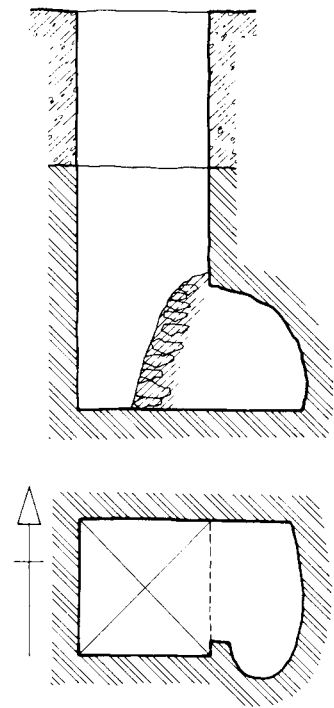

0 1 m

86. G 6033, shaft D: Plan, section, and faces of pit

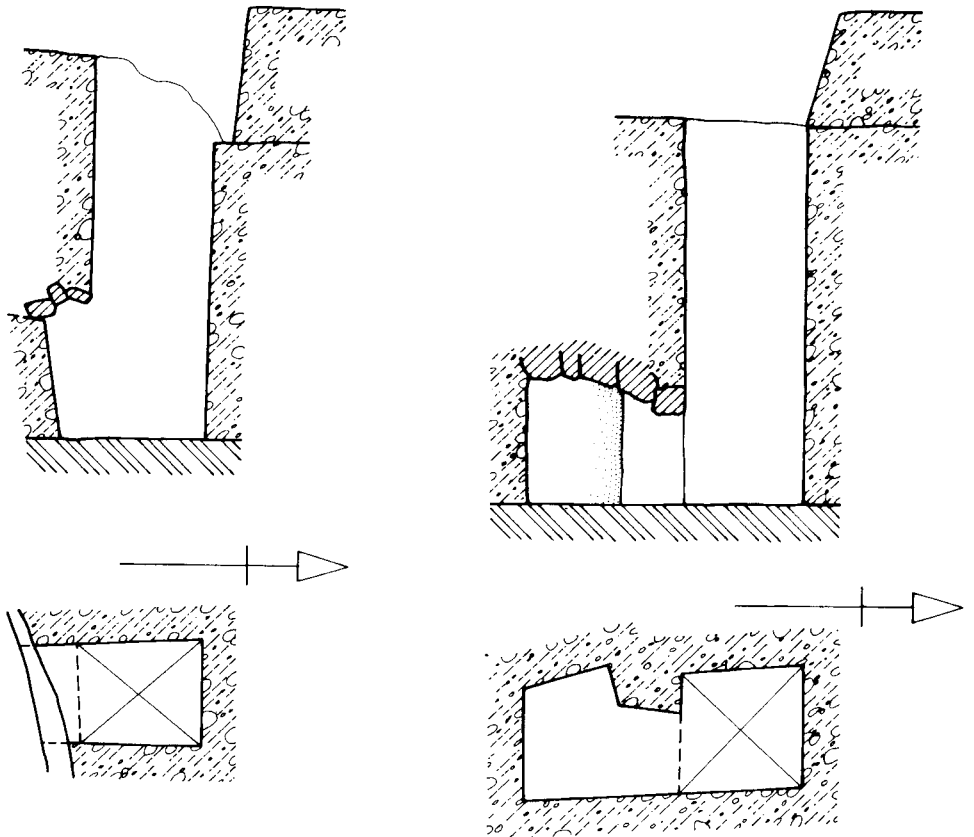

0 1 2 3 4 5 m

87. G 6034, shaft C:
Plan and section

88. G 6034, shaft D:
Plan and section

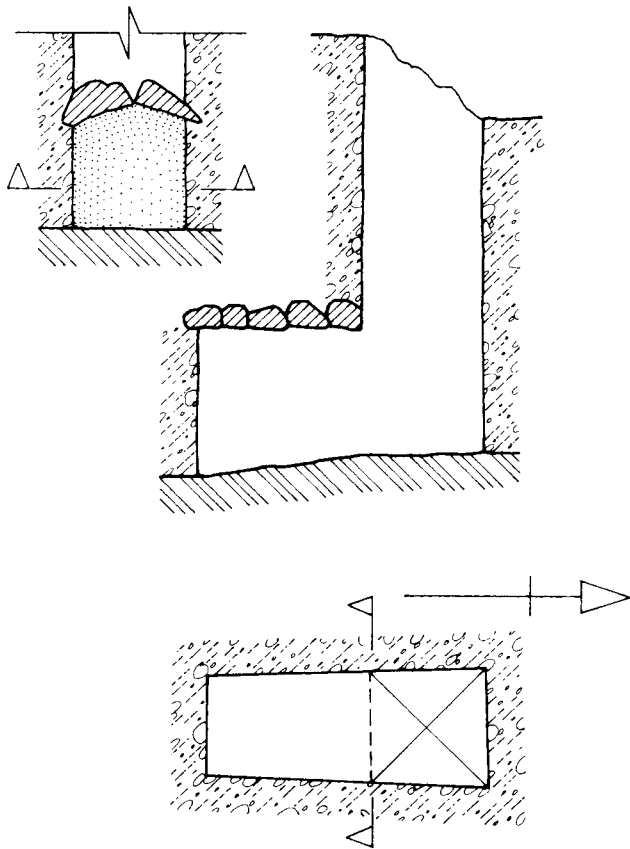

0 1 2 m

89. G 6034, shaft E: Plan and sections

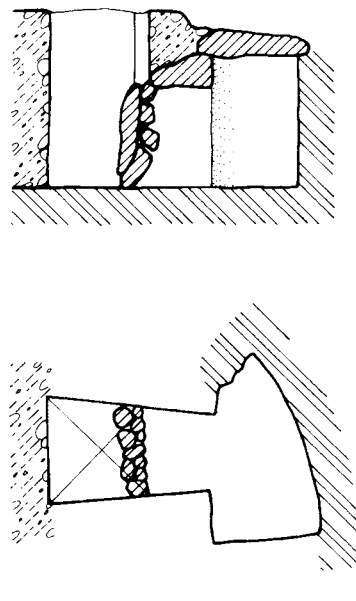

0 1 2 m

90. G 6034, shaft F: Plan and section

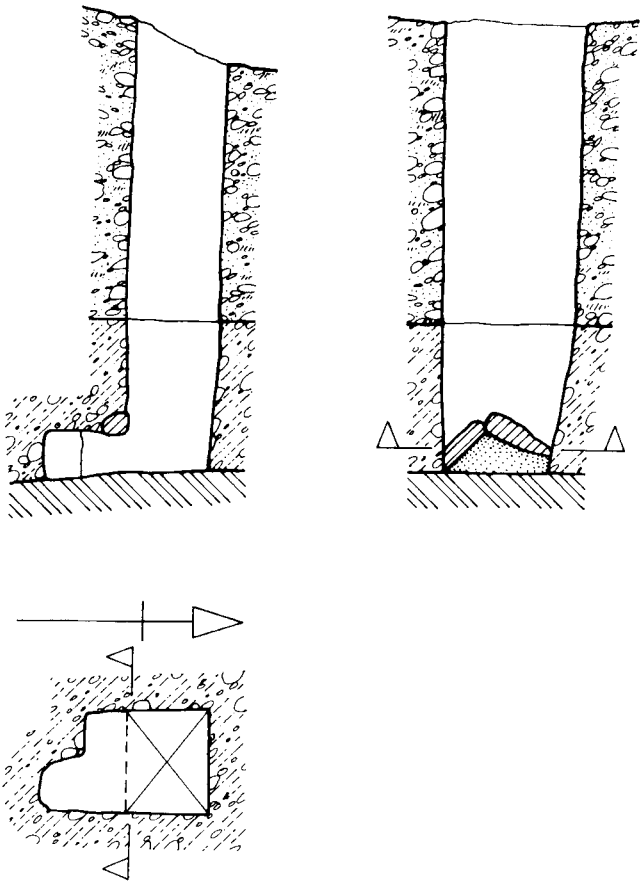

91. G 6034, shaft G: Plan and sections

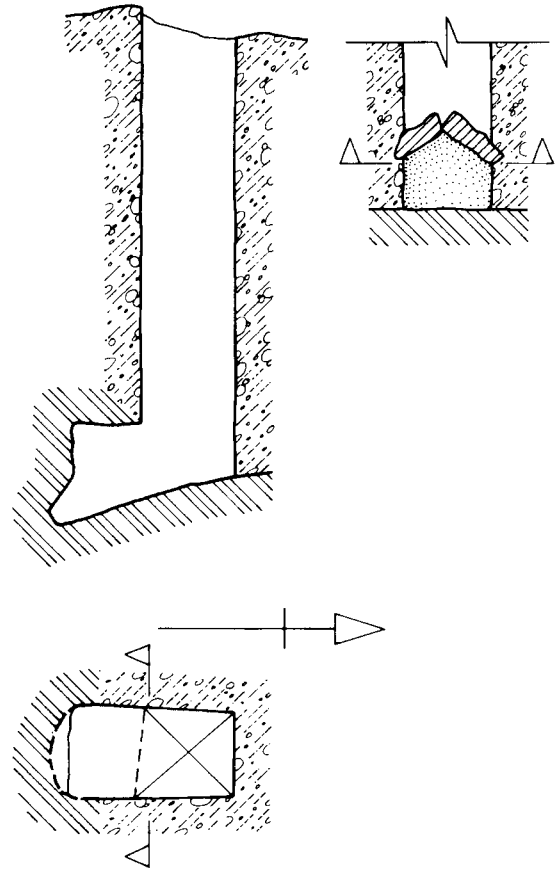

92. G 6034, shaft H: Plan and sections

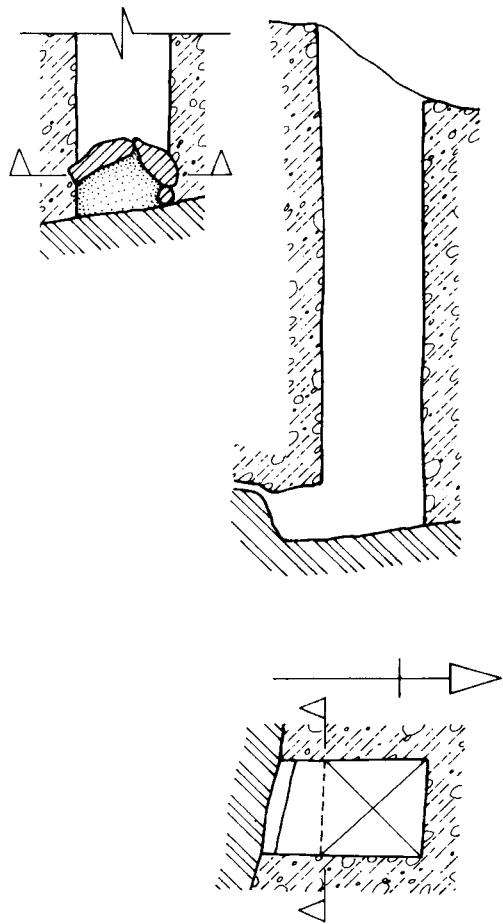

93. G 6034, shaft I: Plan and sections

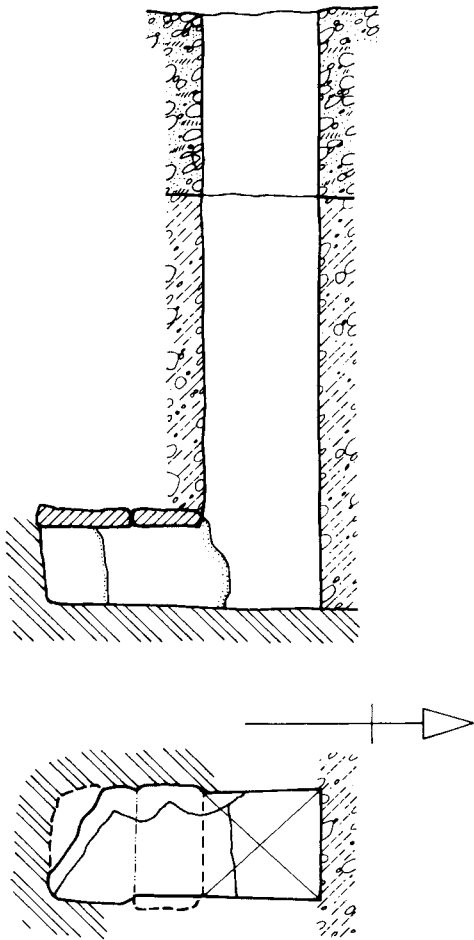

94. G 6034, shaft K: Plan and section

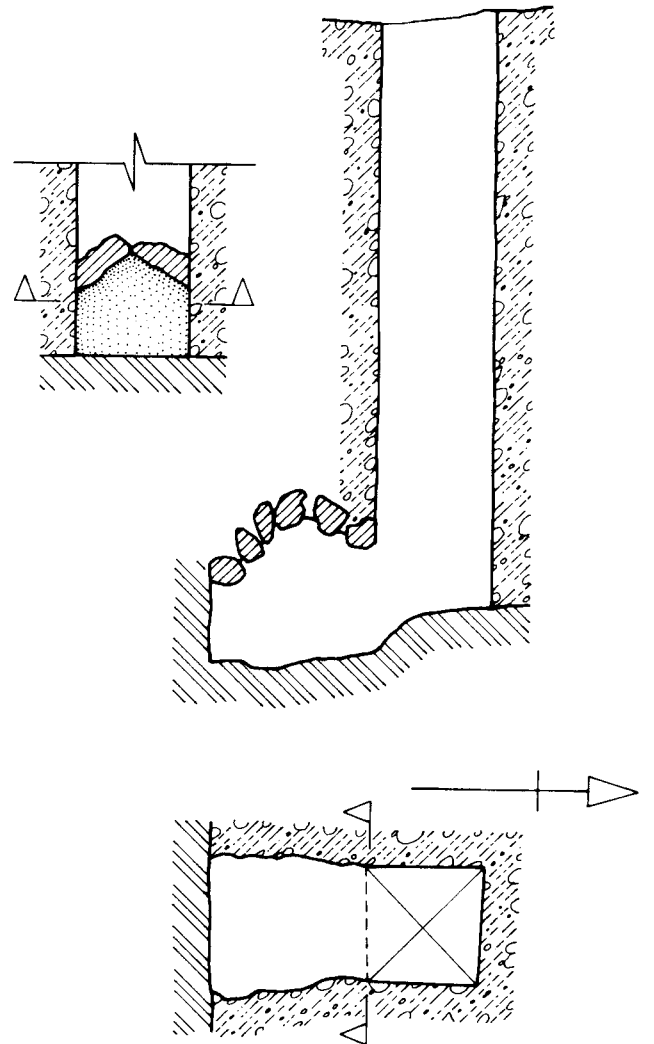

95. G 6034, shaft L: Plan and sections

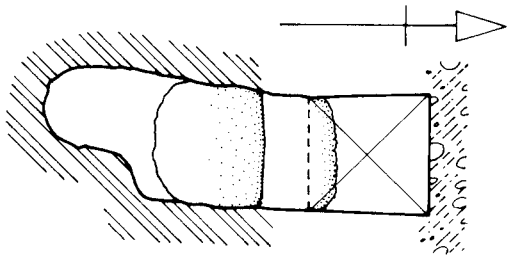
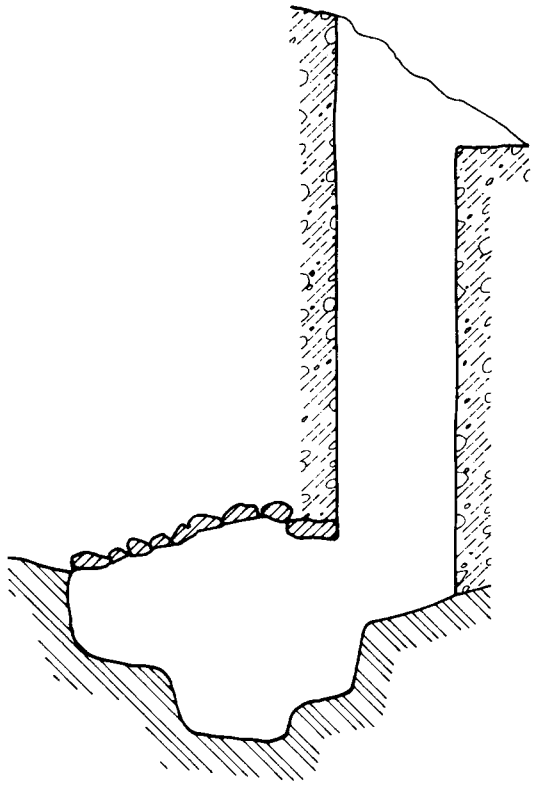

96. G 6034, shaft M: Plan and section

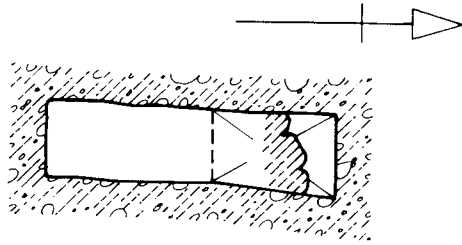
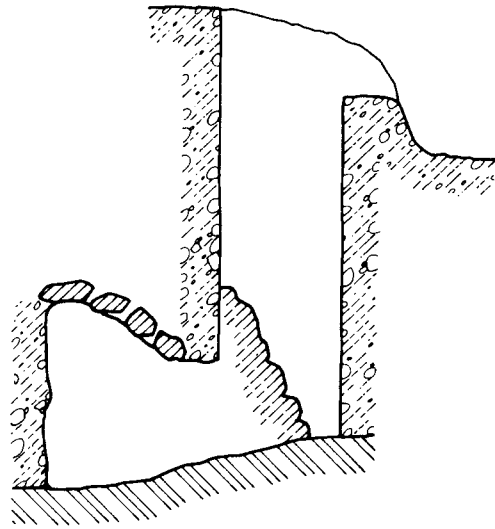

97. G 6034, shaft N: Plan and section

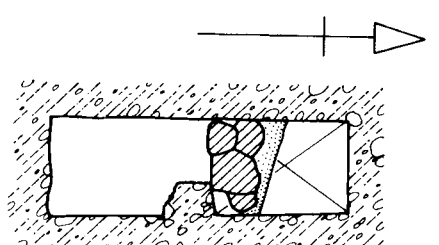
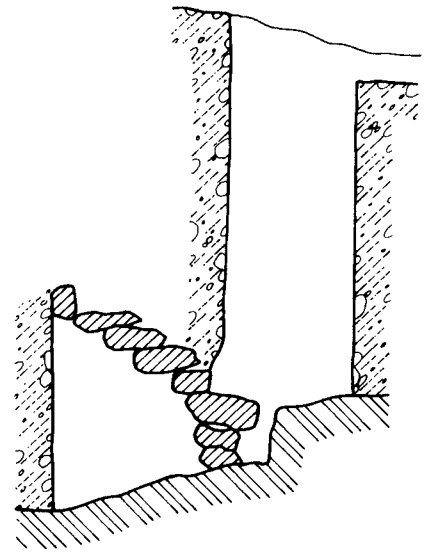

98. G 6034, shaft O: Plan and section

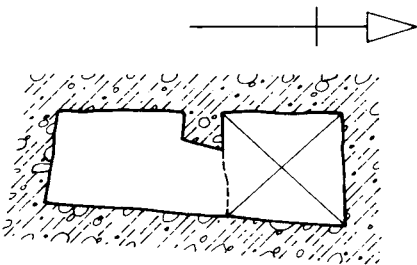
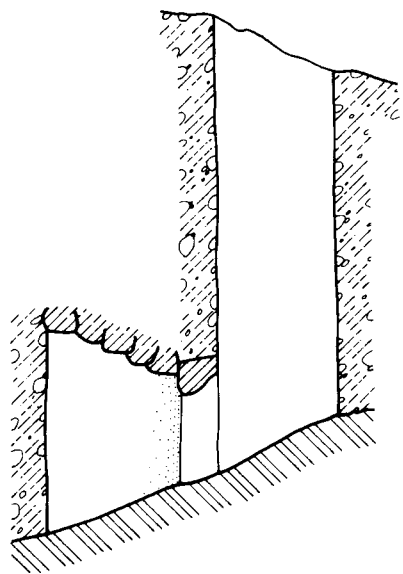

99. G 6034, shaft P: Plan and section

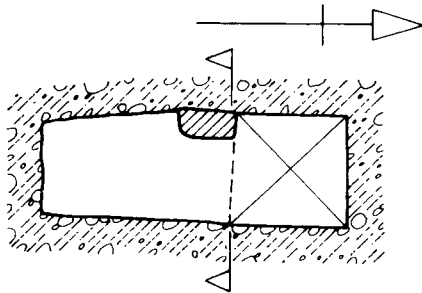
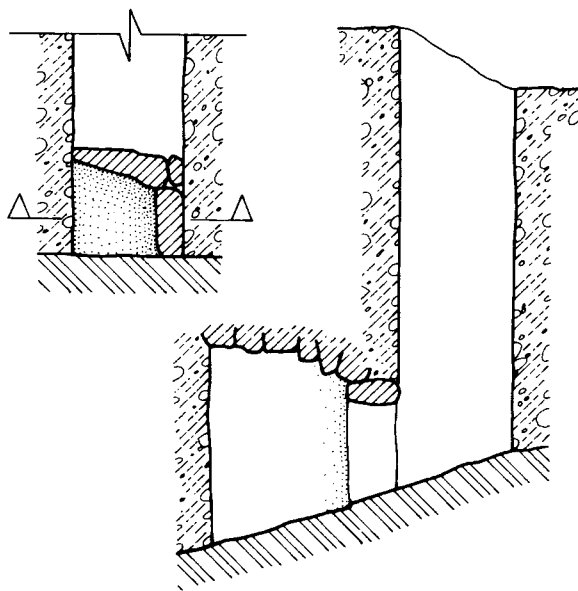

100. G 6034, shaft Q: Plan and sections

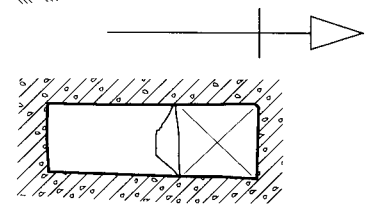
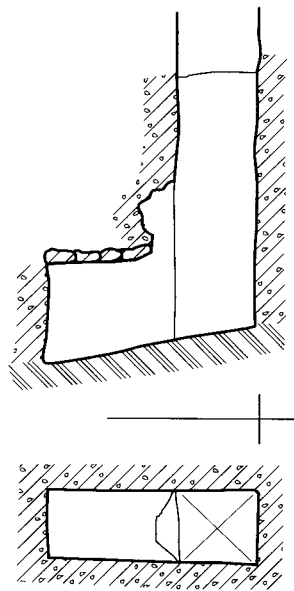

101. G 6034, shaft R:
Plan and section

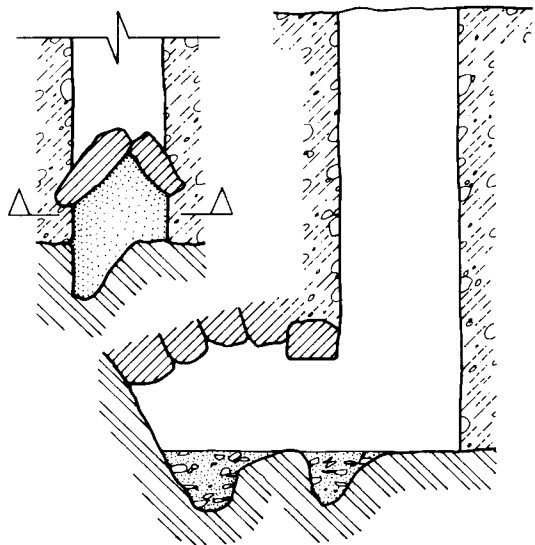

102. G 6035, shaft A:
Plan and sections

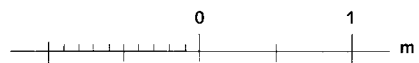
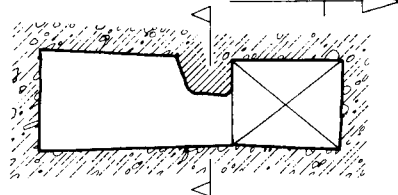
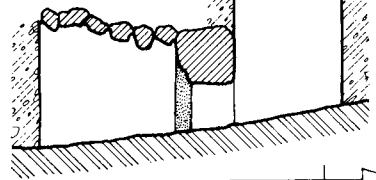
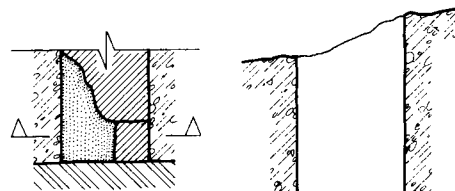
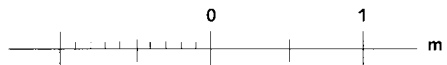
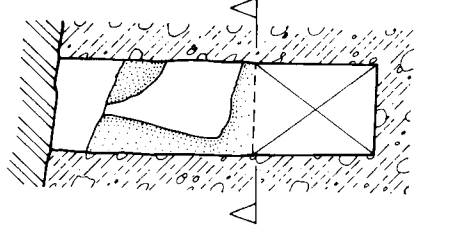

103. G 6035, shaft B: Plan and sections

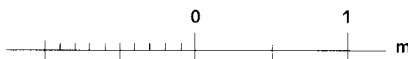
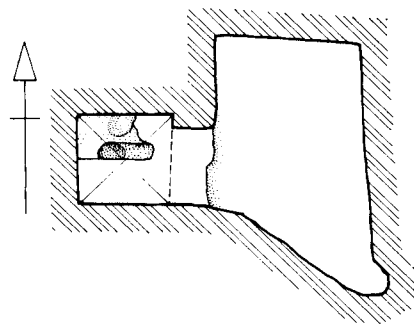
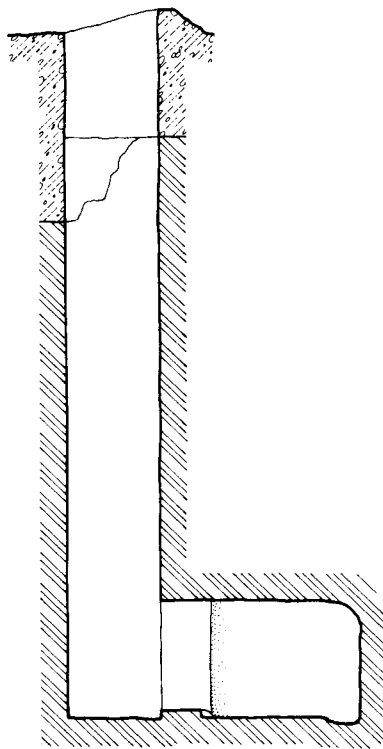

104. G 6036, shaft A: Plan and section

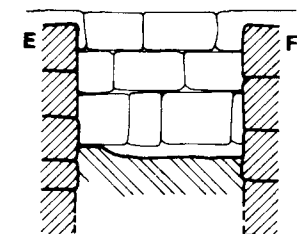
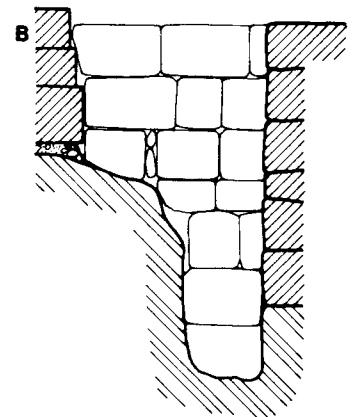
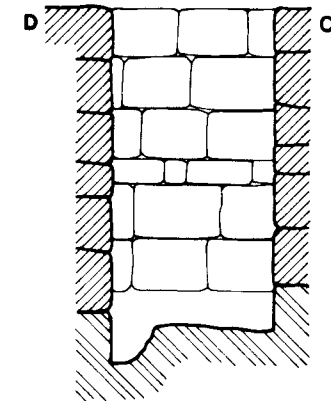
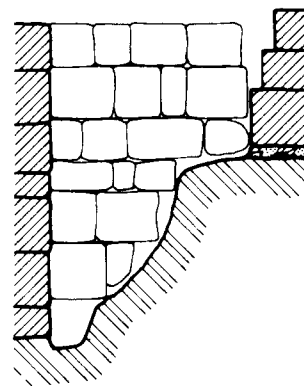
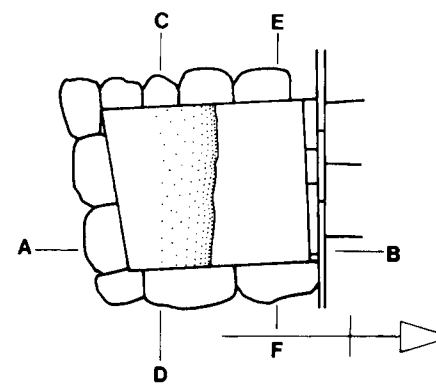

105. G 6037, shaft X: Plan and sections

106. G 6037, shaft Y:
Plan and sections

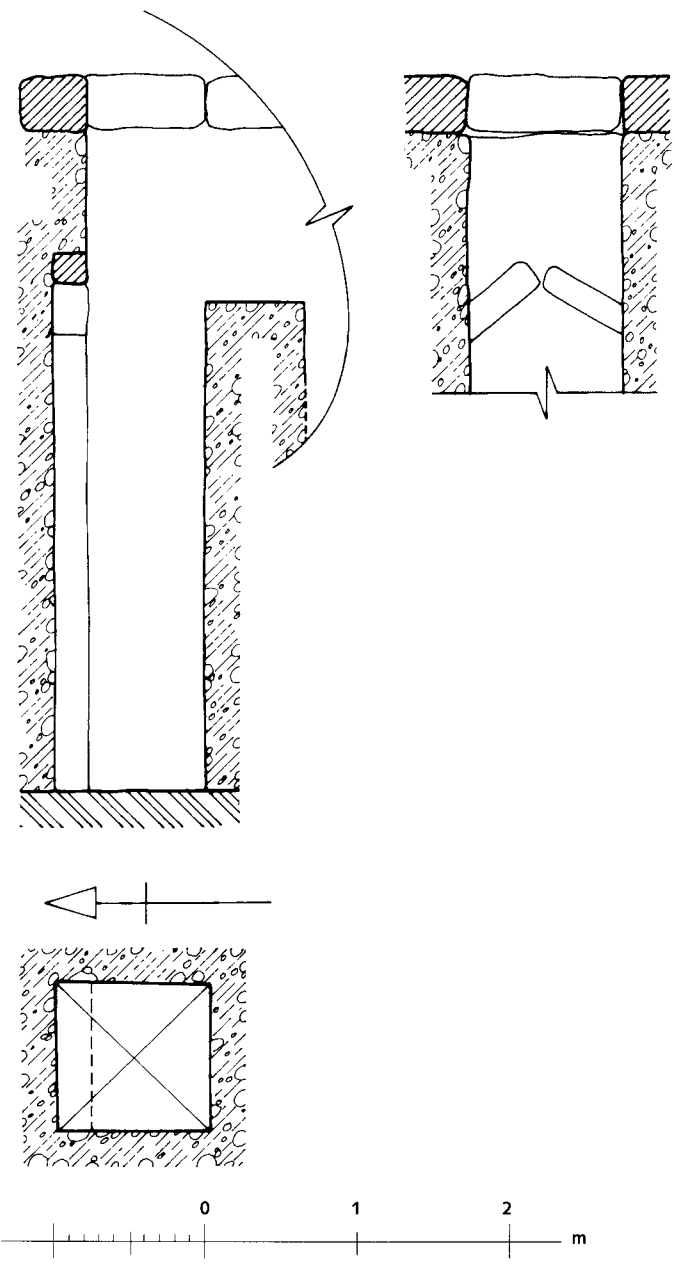
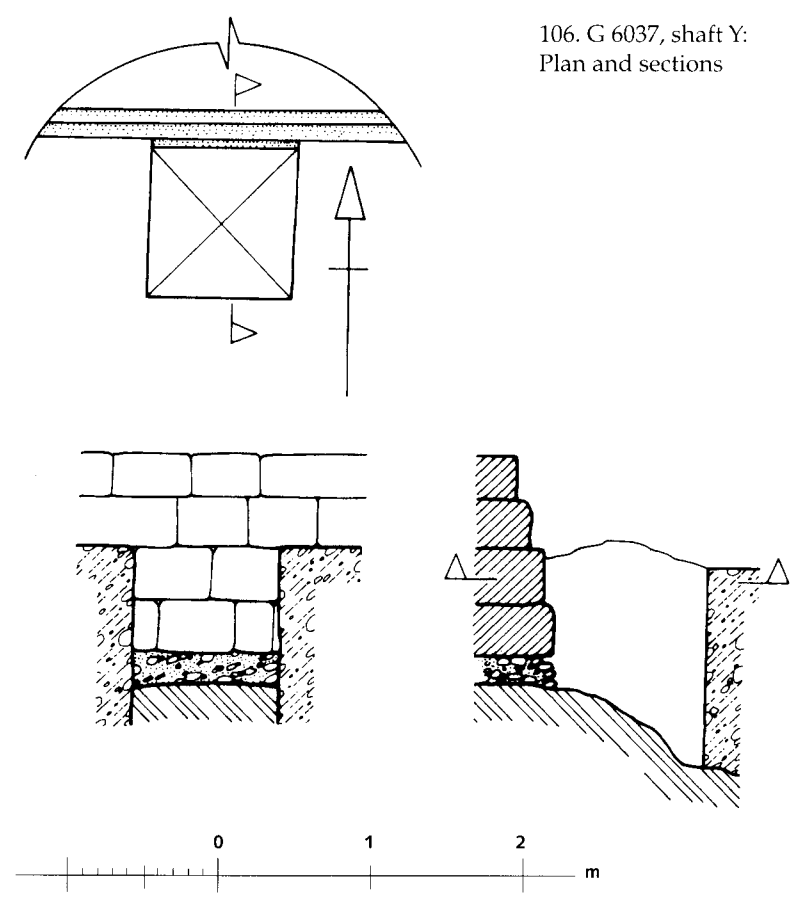

107. G 6040, shaft A: Plan and sections

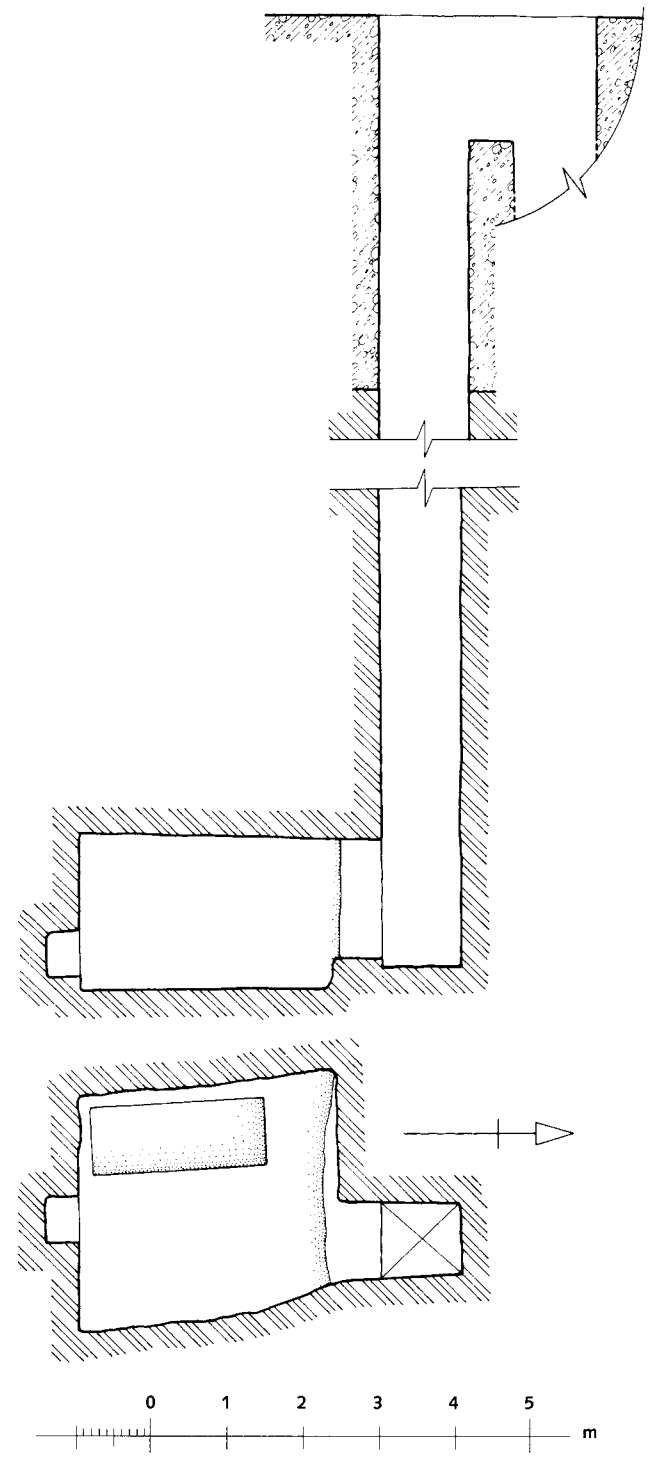

108. G 6040, shaft B: Plan and section

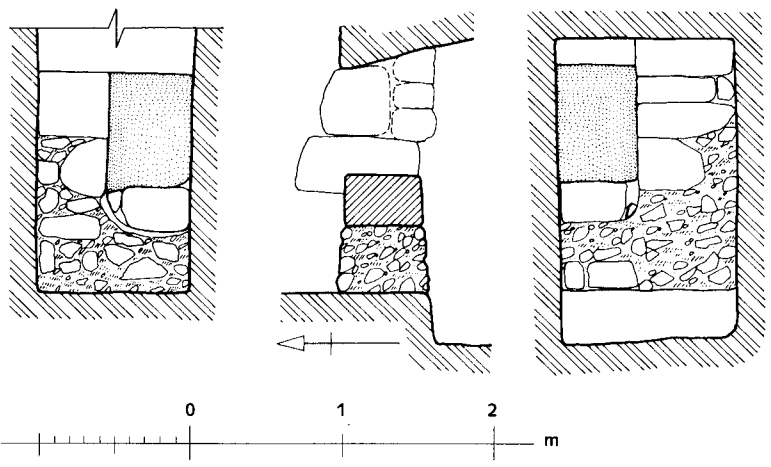

109. G 6040, shaft B: Blocking of burial chamber

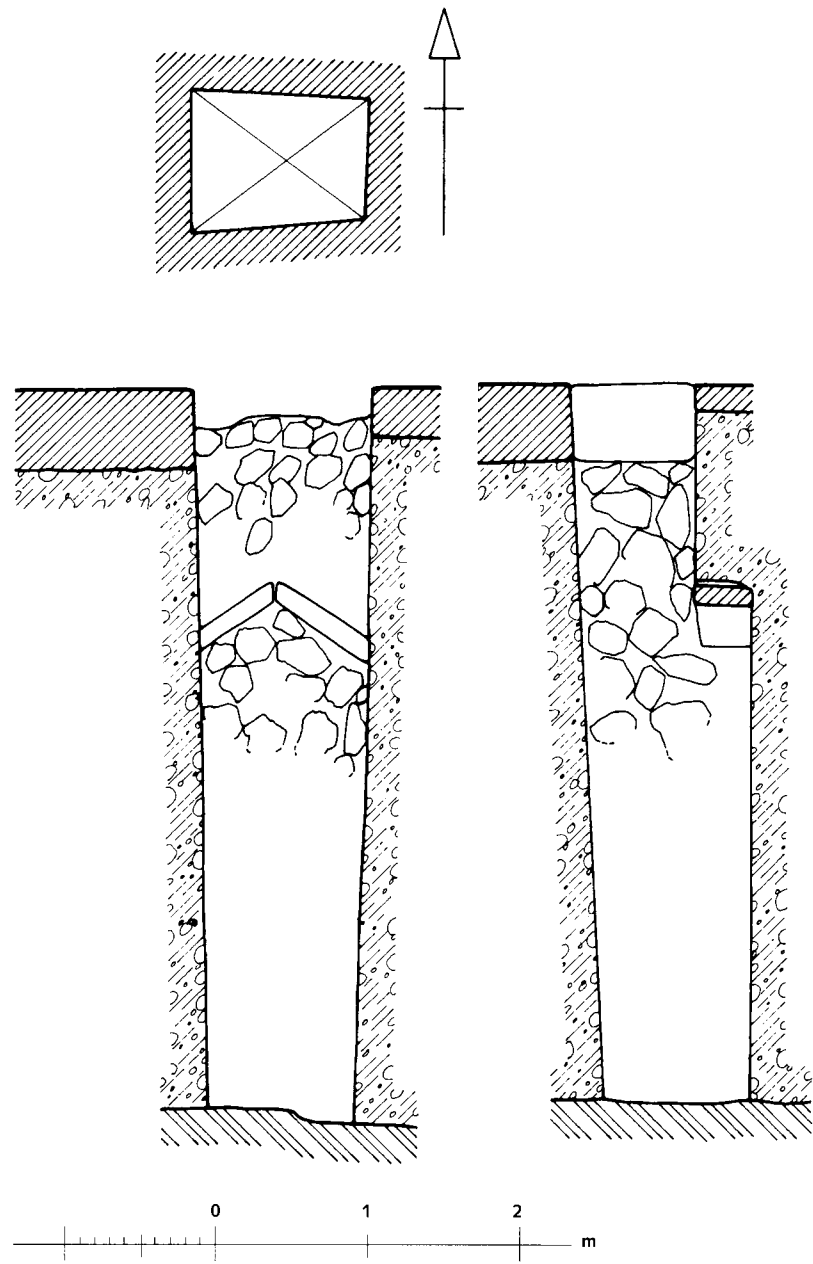

110. G 6040, shaft C: Plan and sections

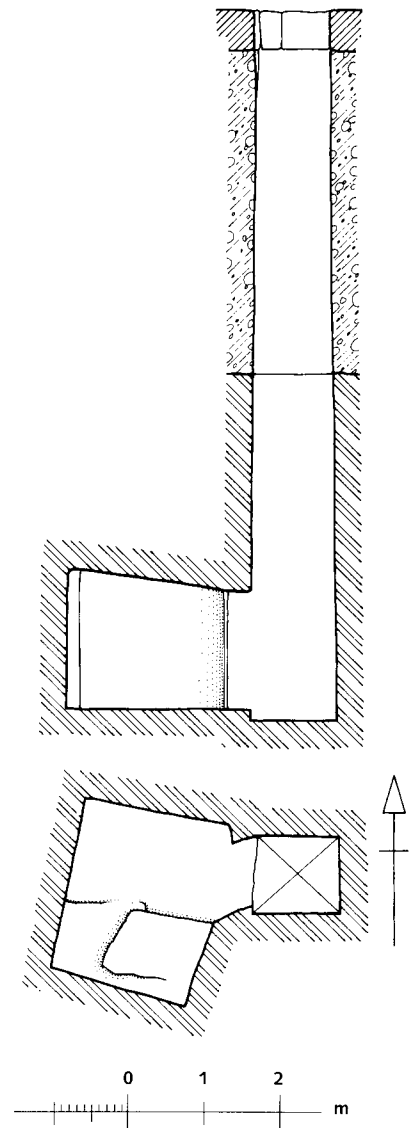

111. G 6040, shaft D: Plan and section

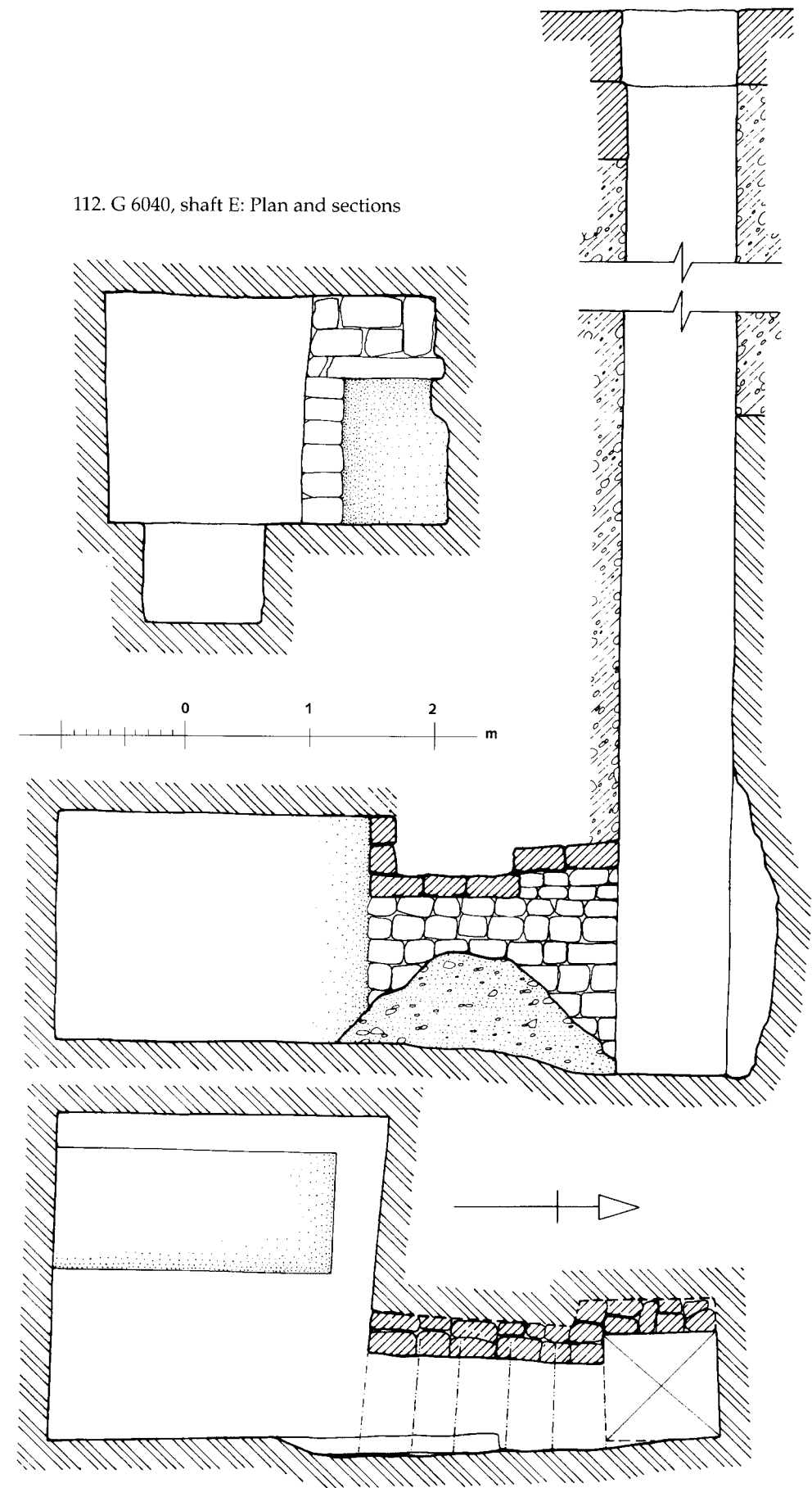

112. G 6040, shaft E: Plan and sections

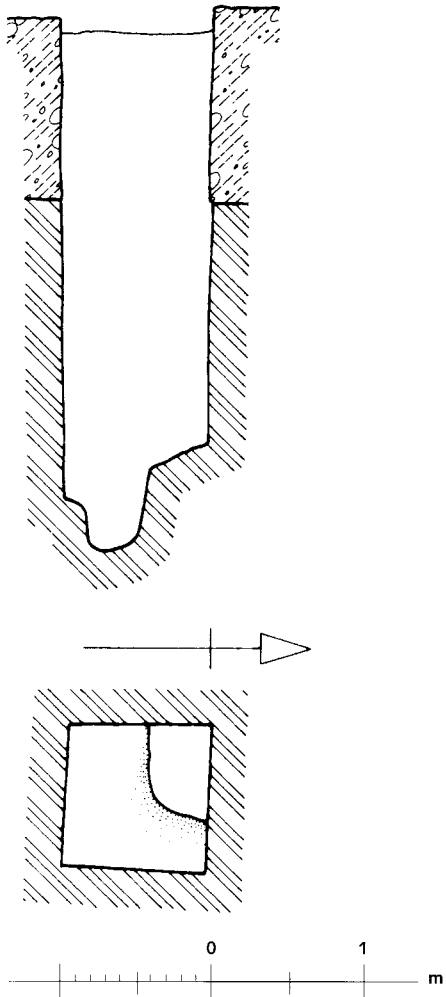

113. G 6041, shaft A: Plan and section

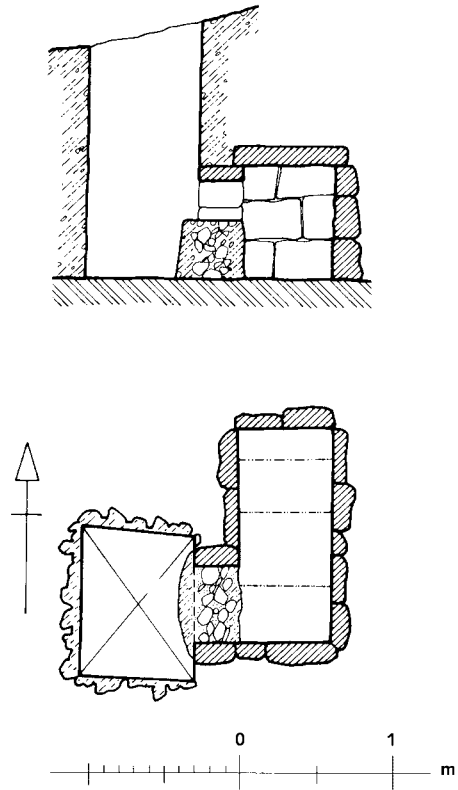

114. G 6041, shaft D: Plan and section

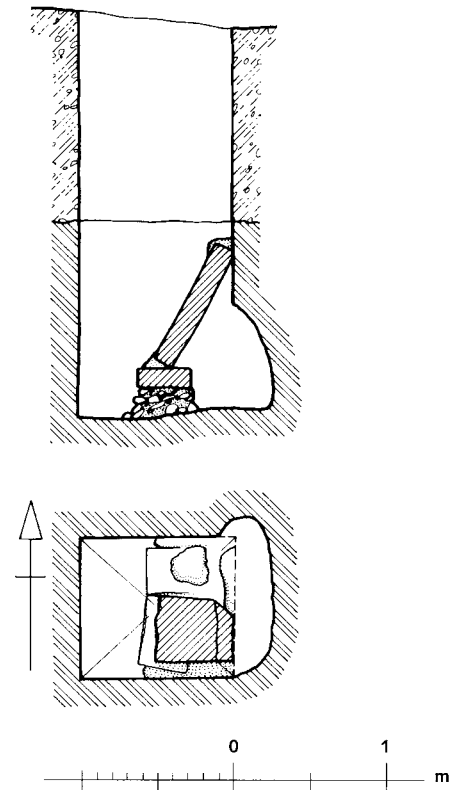

115. G 6041, shaft E: Plan and section

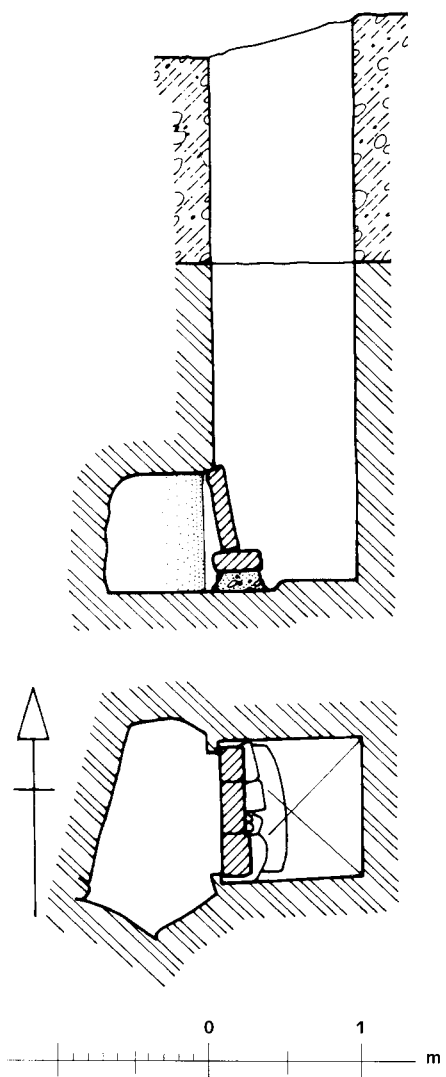

116. G 6041, shaft F: Plan and section

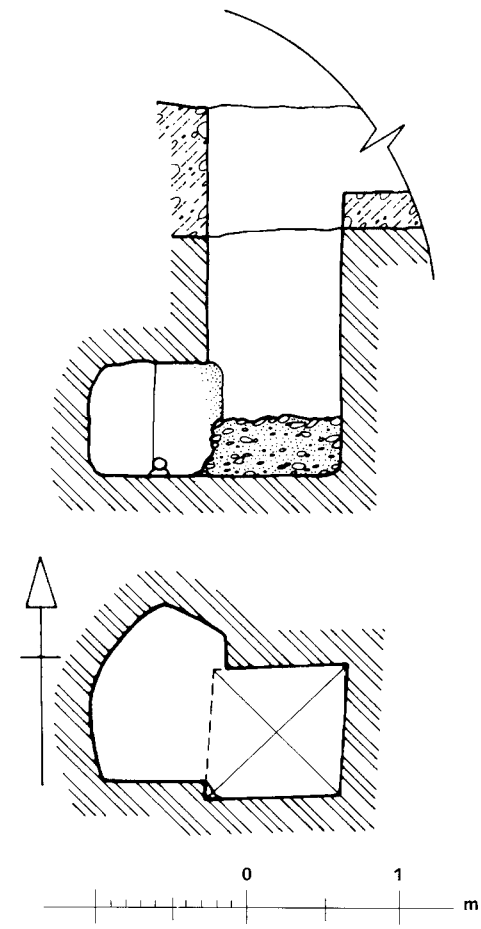

117. G 6041, shaft X: Plan and section

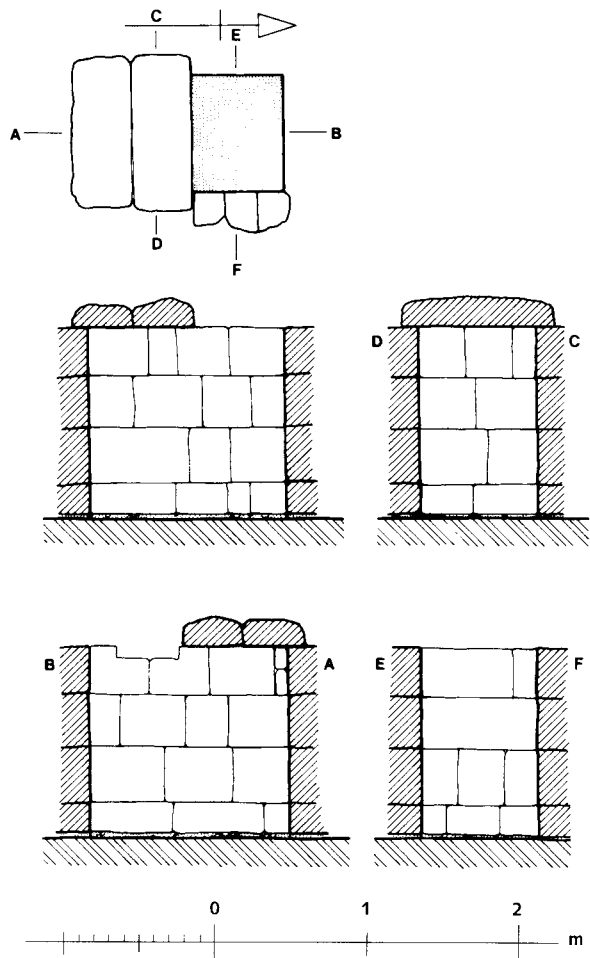

118. G 6042: Plan and sections of serdab

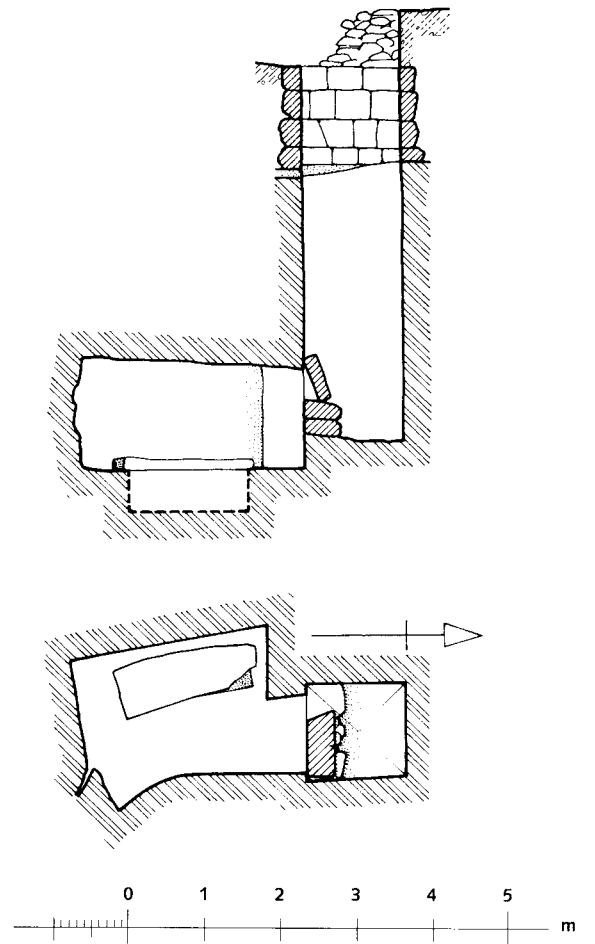

119. G 6042, shaft A: Plan and section

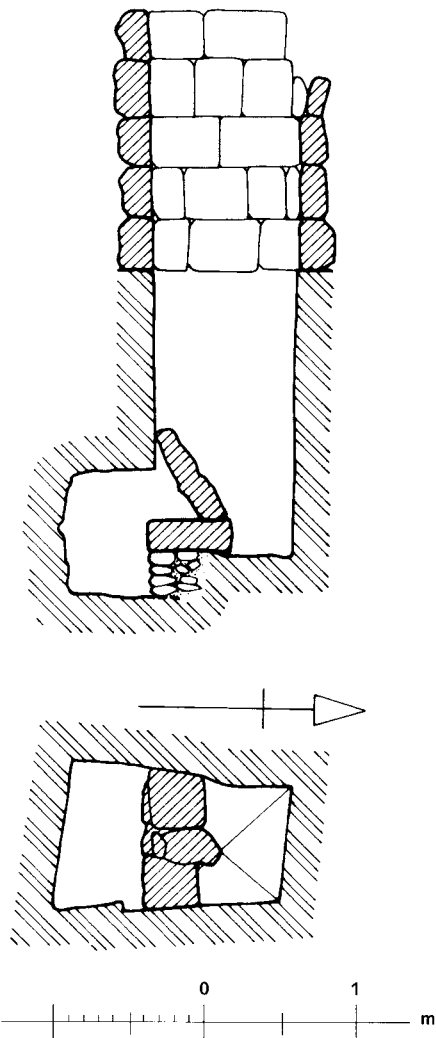

120. G 6042, shaft B: Plan and section

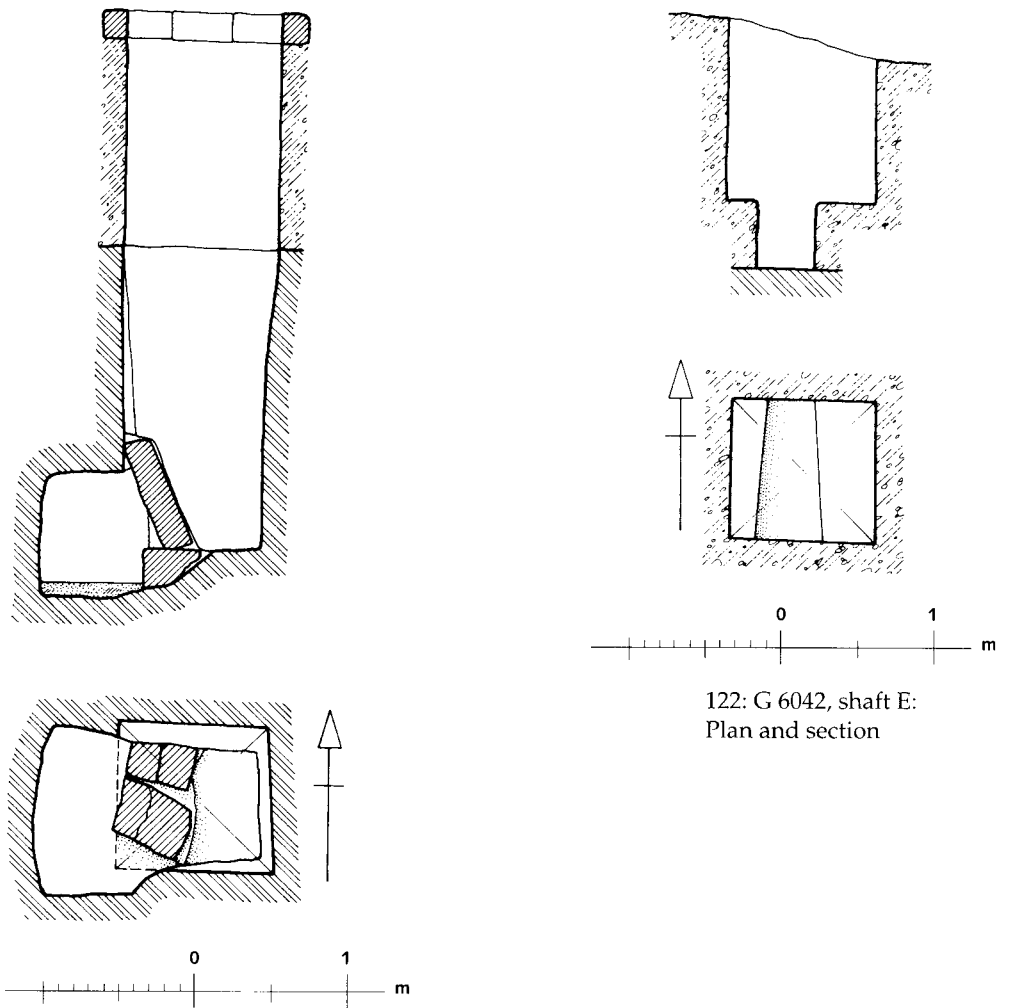

122. G 6042, shaft E:
Plan and section

121. G 6042, shaft D: Plan and section

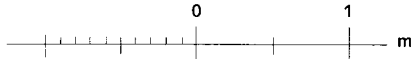
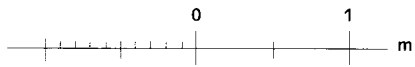
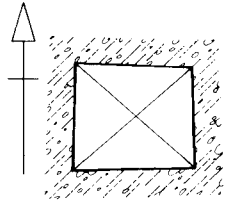
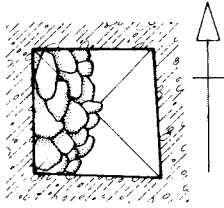
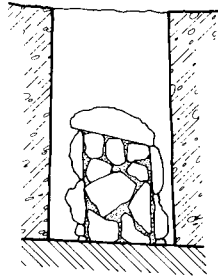
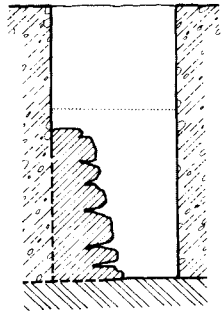

123. G 6042, shaft F:
Plan and section

124. G 6042, shaft G:
Plan and section

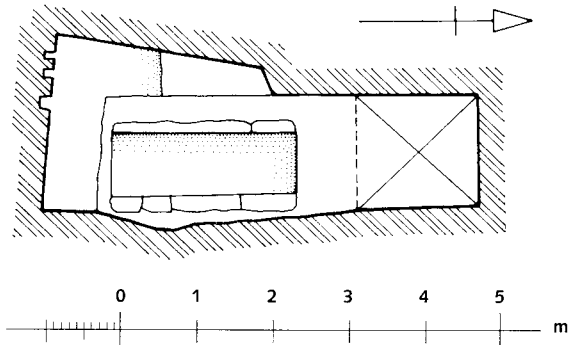
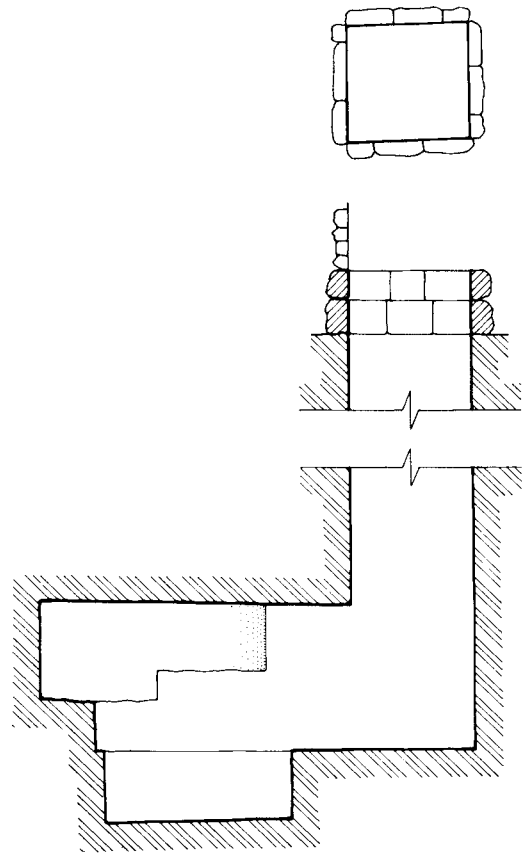

125. G 6050, shaft A: Plan and section

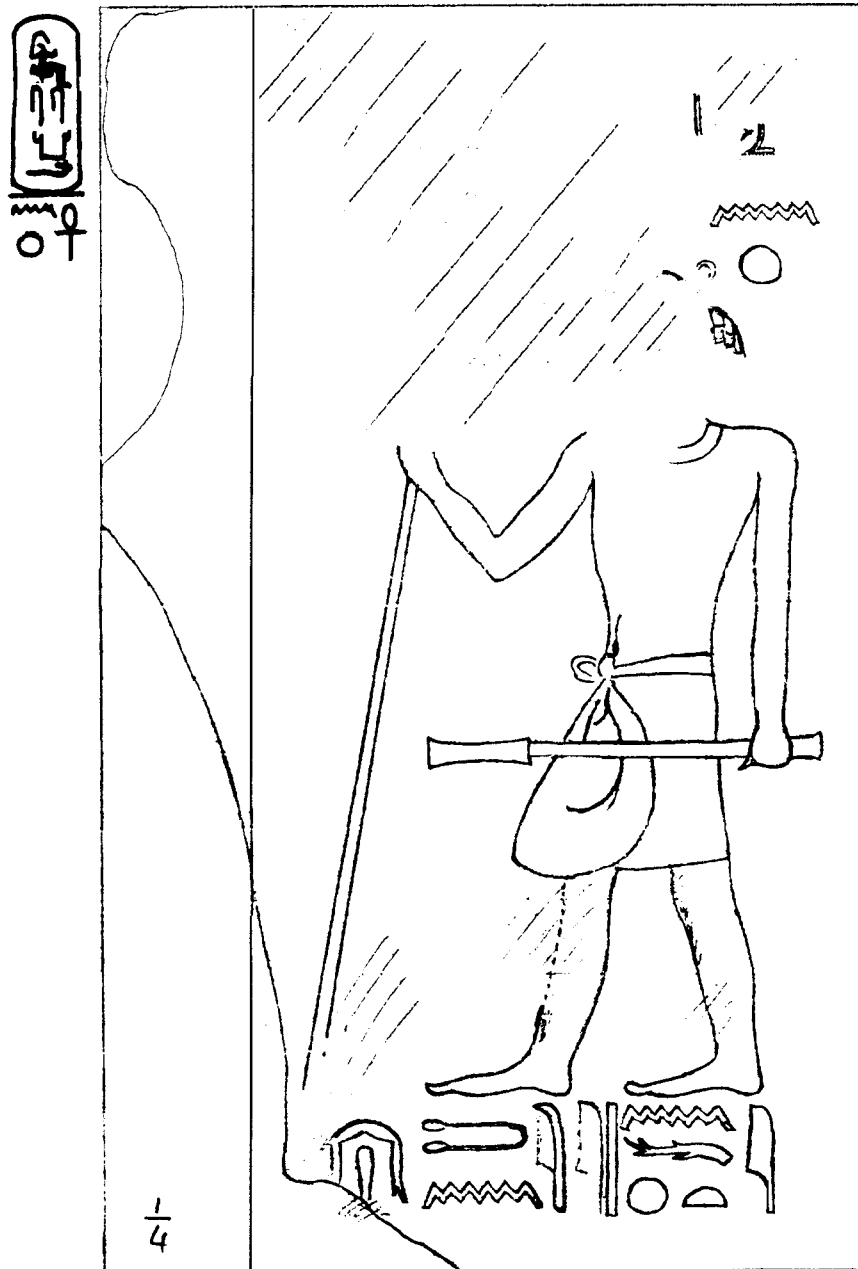

126a. G 6040: 25-11-139 (actual object not available for redrawing)

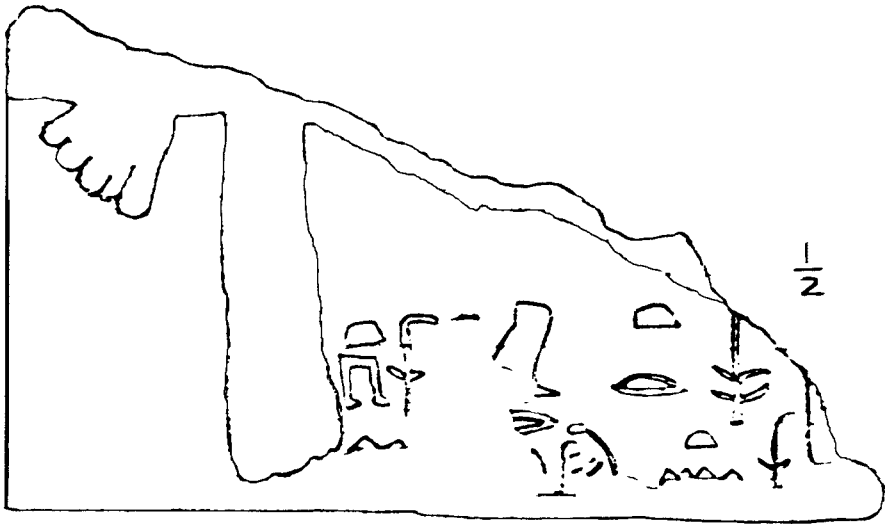

126b. G 6020: 25-11-2 (object register sketch; actual object not available for redrawing)

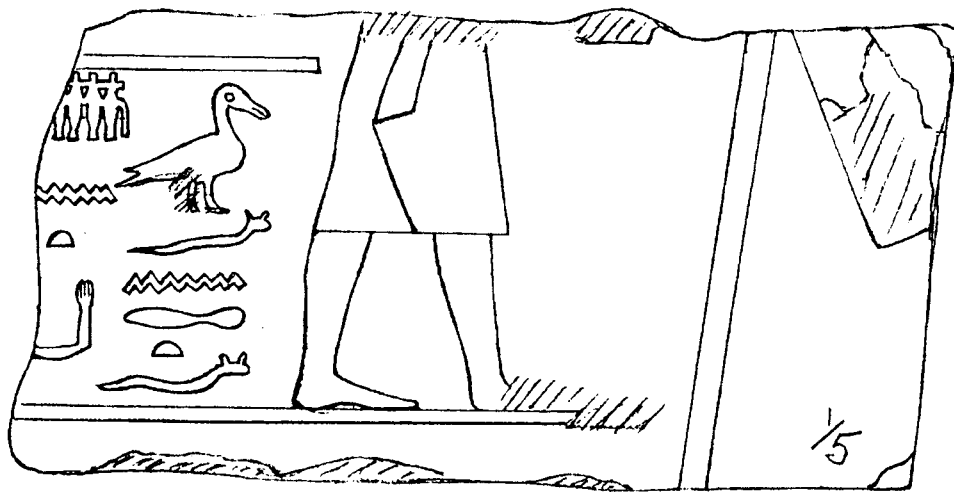

126c. G 6052: 25-11-203 (object register sketch; actual object not available for redrawing)

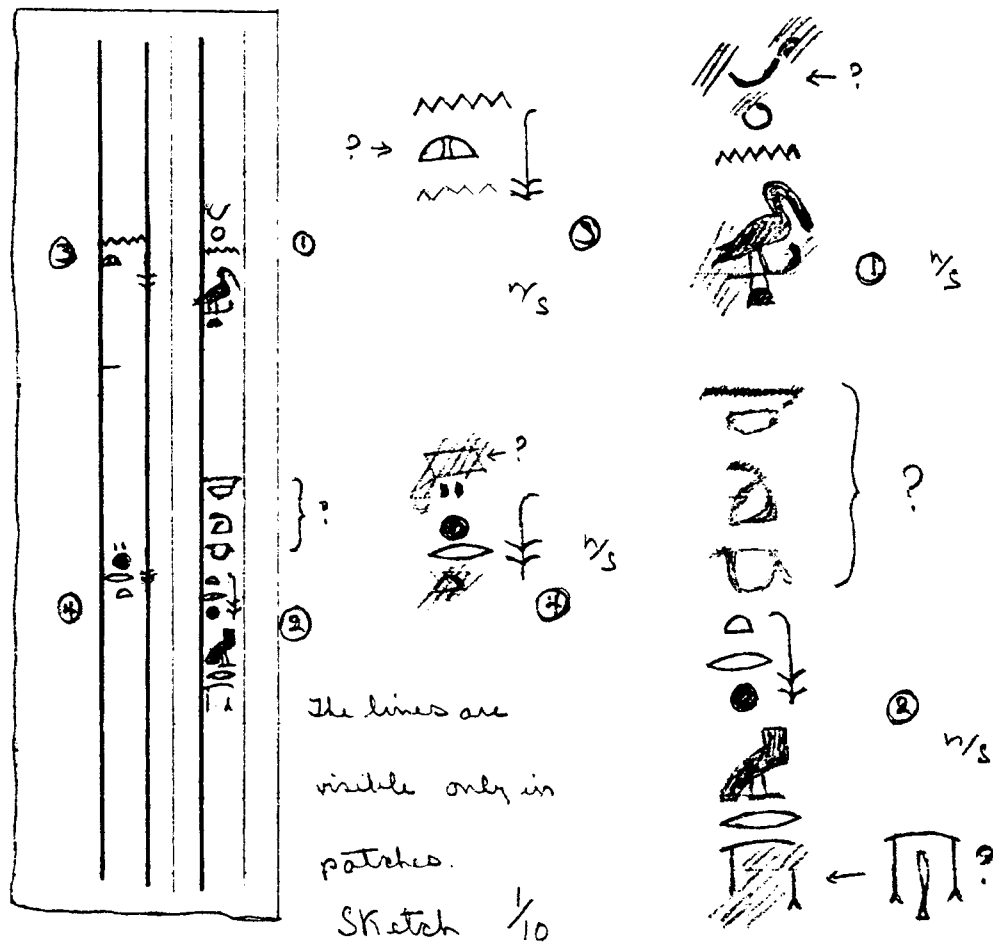

126d. G 6052: 25-11-211 (object register sketch; actual object not available for redrawing)

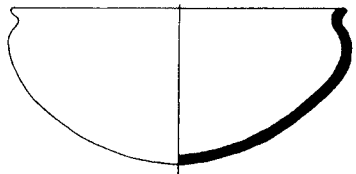

G 6010A: 24-11-64

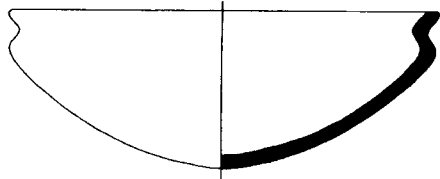

G 6010A: 25-11-101

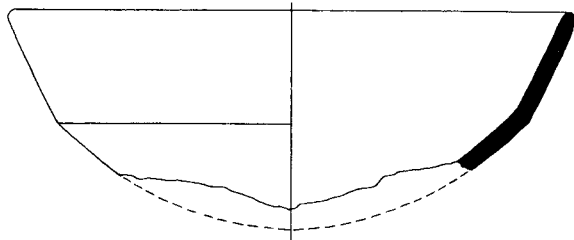

G 6010A: 25-11-66

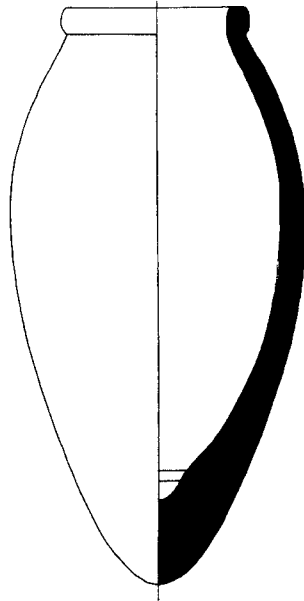

G 6010 "b": 25-11-125

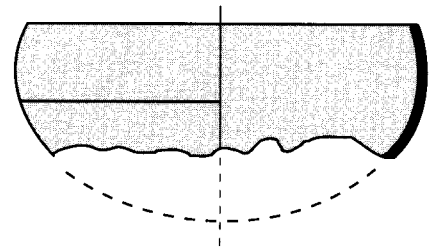

G 6010A: 25-11-69 (redrawn from tomb card sketch; scale unknown)



G 6010A: 25-11-72

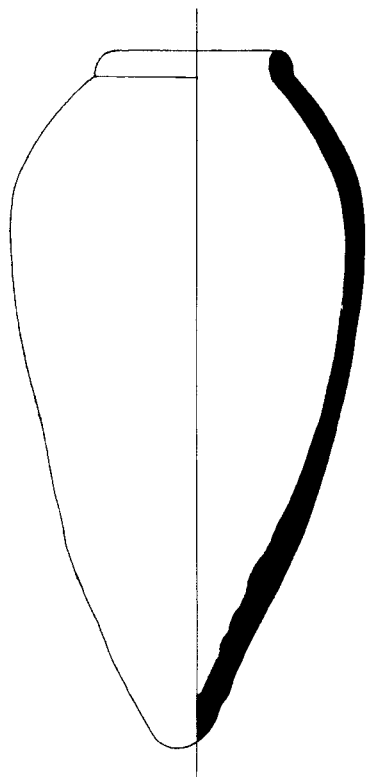
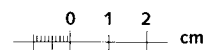
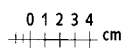

G 6012A: 25-12-282

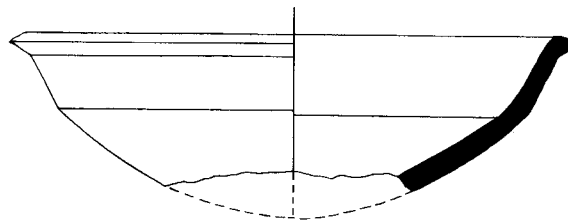

G 6013A: 25-11-121

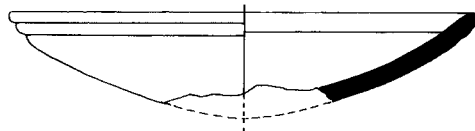

G 6013A: 25-11-118

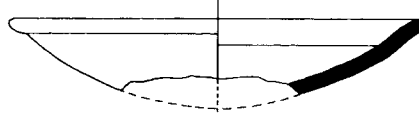

G 6013A: 25-11-119

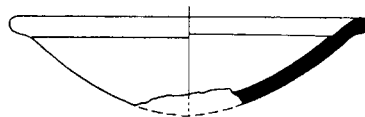

G 6013A: 25-11-120

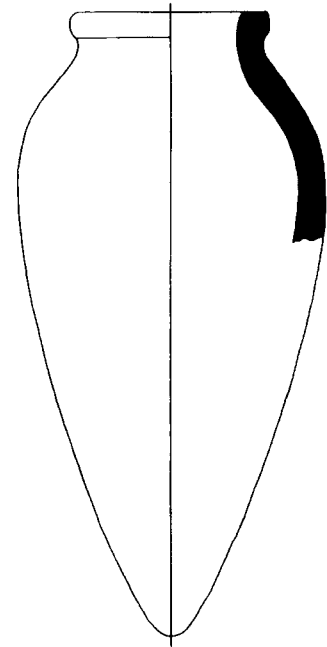

G 6013C: 25-11-96

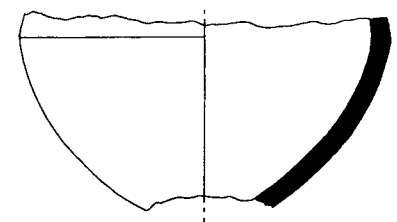

G 6013A: 25-11-123

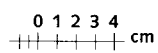

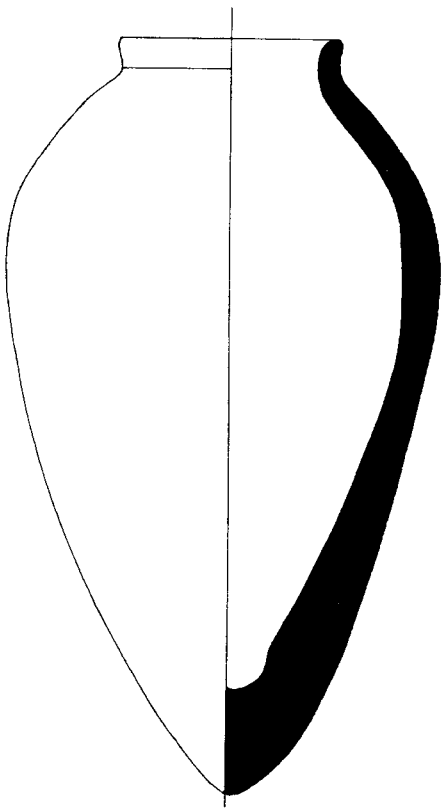

G 6020A: 25-11-111

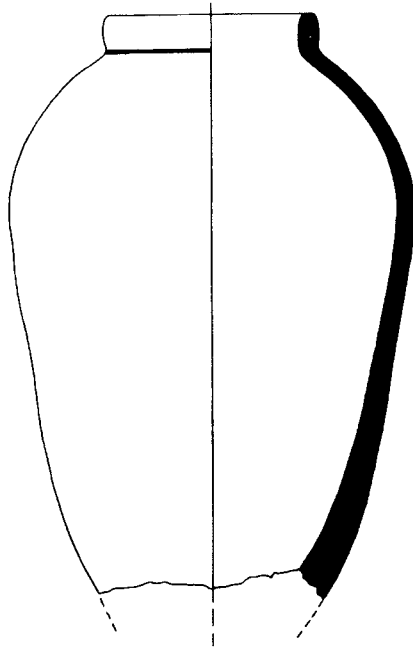

G 6020A: 25-12-45

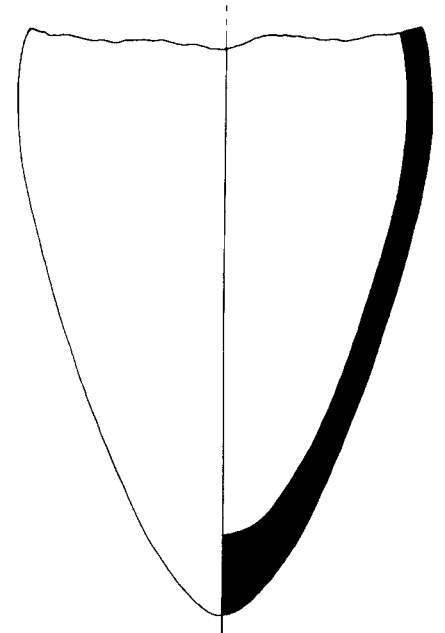

G 6020A: 25-12-27

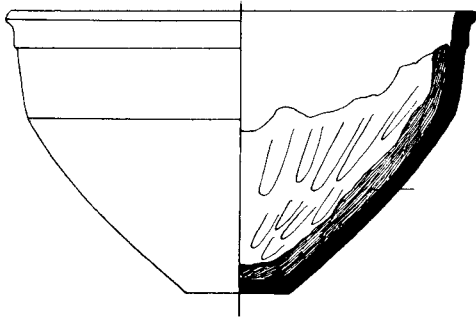

G 6020A: 25-12-50

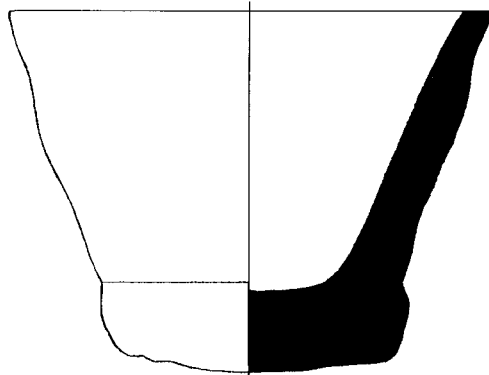

G 6020A: 25-12-28

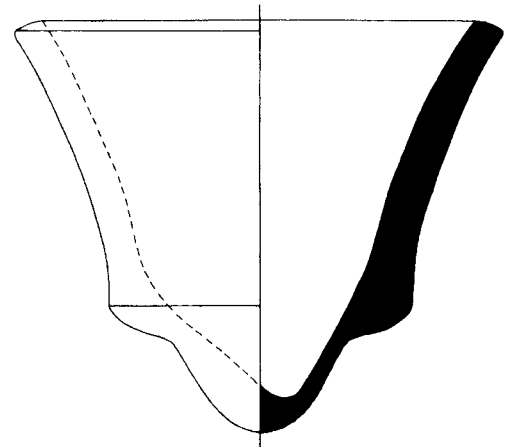

G 6020A: 25-12-82

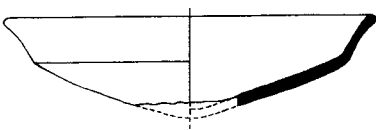

G 6020A: 25-12-83

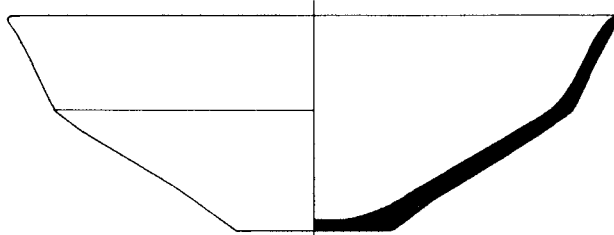

G 6020A: 25-12-77

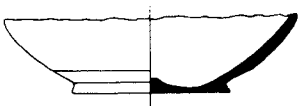

G 6020: 25-12-81

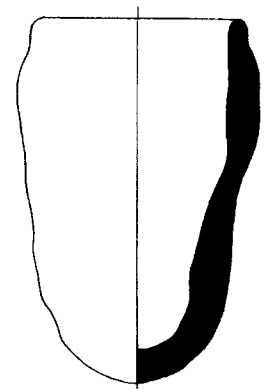
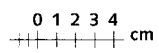

G 6020A: 25-12-110

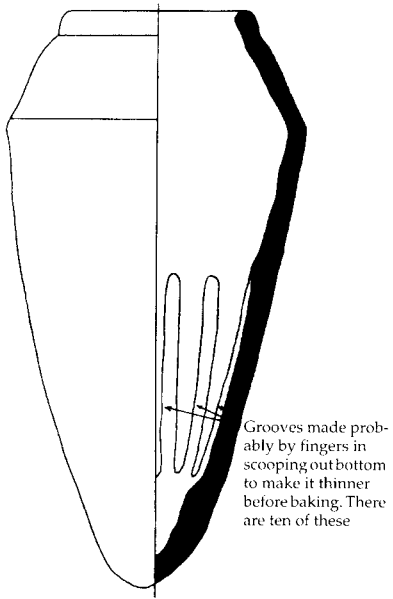

Grooves made probably by fingers in scooping out bottom to make it thinner before baking. There are ten of these

G 6028E: 25-12-221

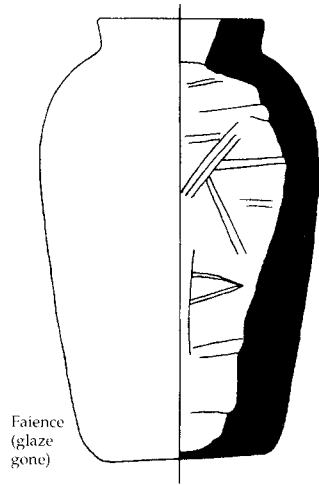

Faïence (glaze gone)

G 6028F: 25-12-229

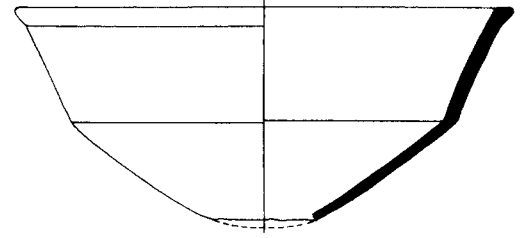
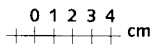

G 6028E: 25-12-223

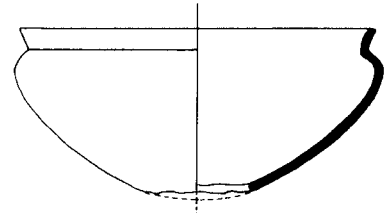

G 6028E: 25-12-224

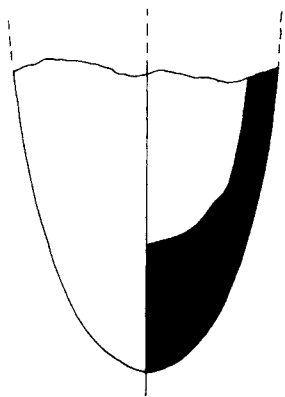

G 6030B: 25-11-77

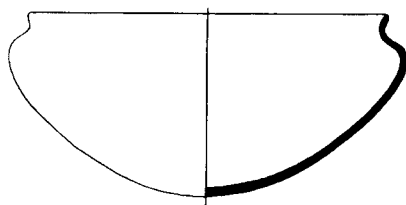

G 6030A: 25-12-3

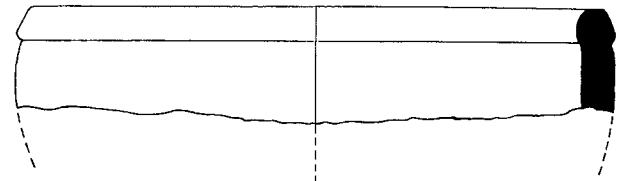

G 6030B: 25-11-80

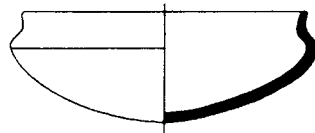

G 6030: 25-11-56

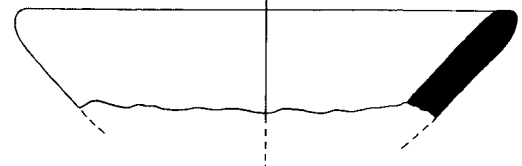

G 6030B: 25-11-93

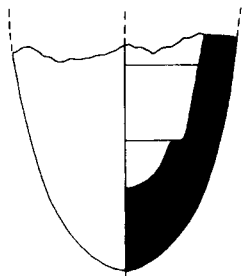

G 6030B: 25-11-76

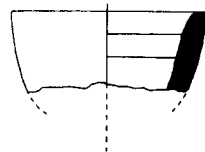

G 6030B: 25-11-79

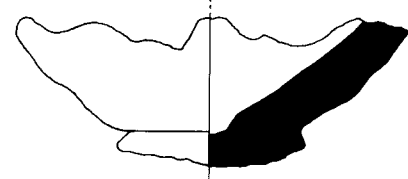

G 6030B: 25-11-92

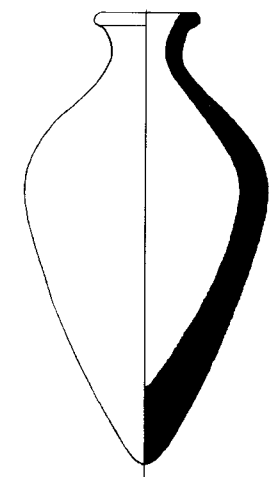

G 6030 serdab : 25-11-50

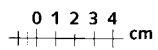

G 6030B: 25-11-84



G 6030B: 25-11-86



G 6030B: 25-11-90

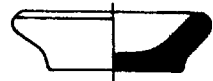

G 6030B: 25-11-85



G 6030B: 25-11-87

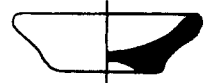

G 6030B: 25-11-88



G 6030A: 25-12-18

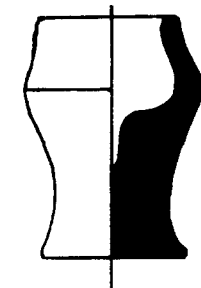

G 6030B: 25-11-89

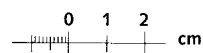

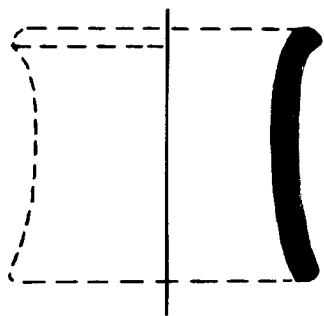

G 6031D: 25-12-132

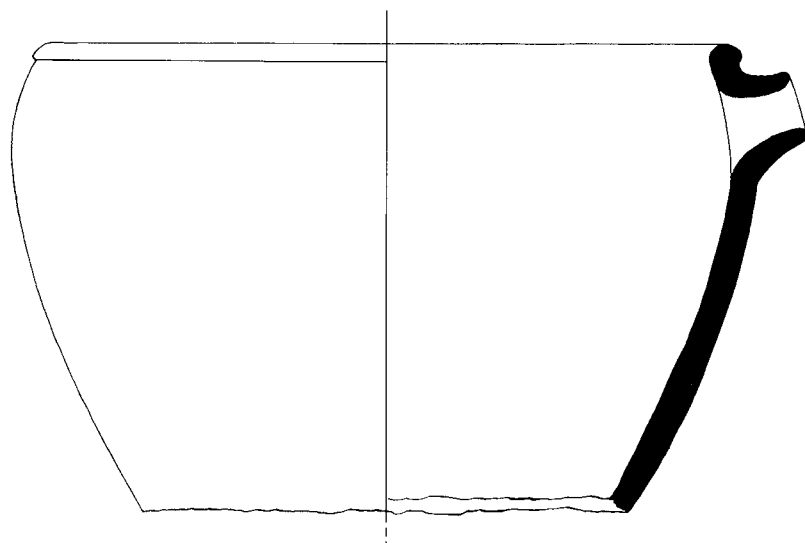
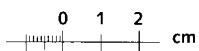

G 6031D: 25-12-133

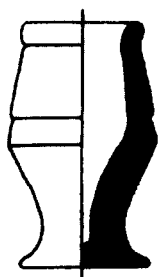
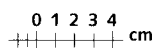

G 6034R: 25-12-144

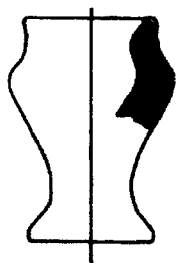

G 6034R: 25-12-146

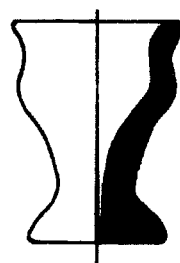

G 6034R: 25-12-145



G 6034R: 25-12-150

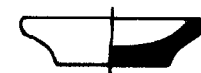

G 6034R: 25-12-150a

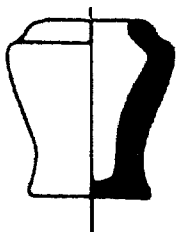

G 6034R: 25-12-148

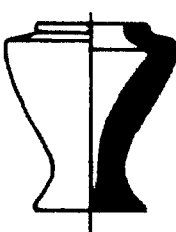

G 6034R: 25-12-149

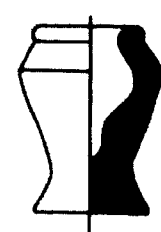

G 6034R: 25-12-147



G 6034R: 25-12-150b



G 6034R: 25-12-150

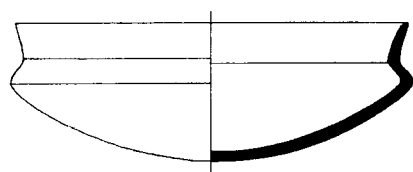
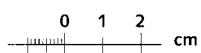

G 6040: 25-12-269

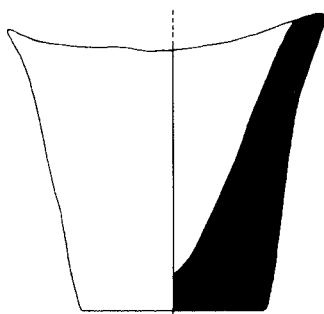

G 6040B: 25-12-269

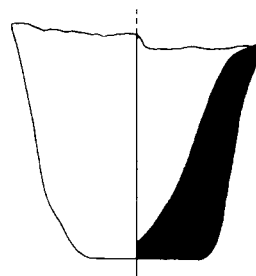

G 6040B: 25-12-270

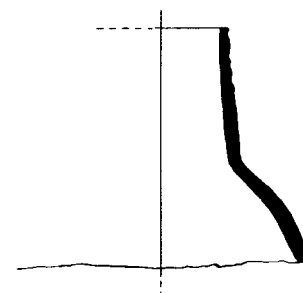

G 6040: 25-12-74

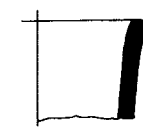
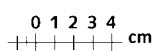

G 6040B:
25-12-268

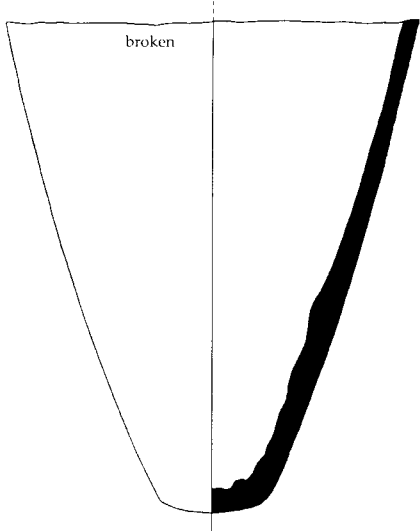

G 6040C: 25-12-73

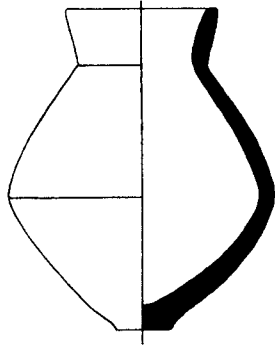

G 6040D: 25-12-54

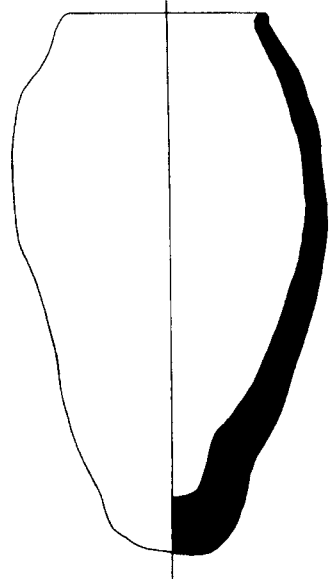

G 6040B: 25-12-122

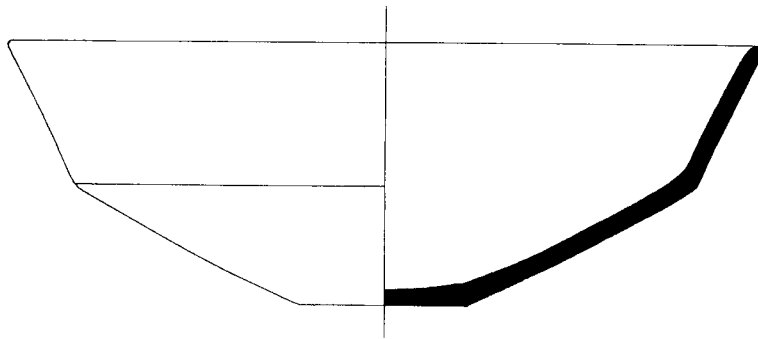

G 6040B: 25-12-267

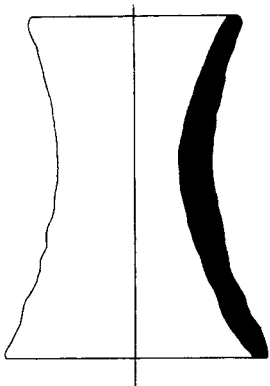

G 6040: 25-12-24

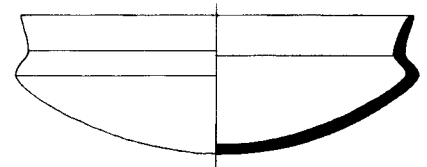
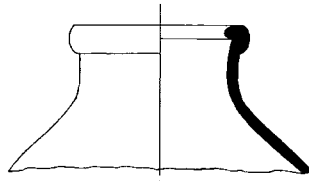

G 6040: 25-12-139

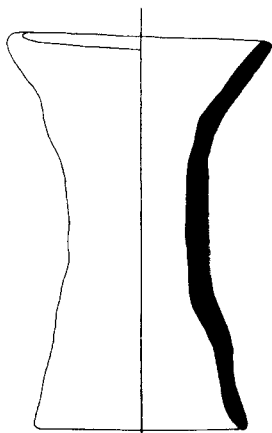

G 6040C: 25-12-71

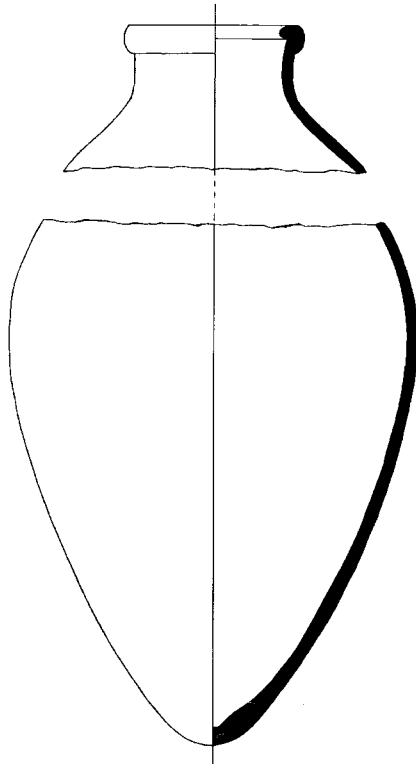

G 6040D: 25-12-69

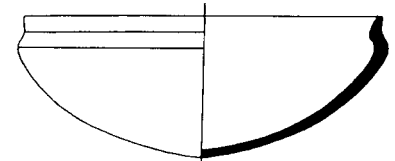

G 6040D: 25-12-55



G 6040C: 25-12-51

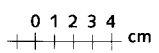

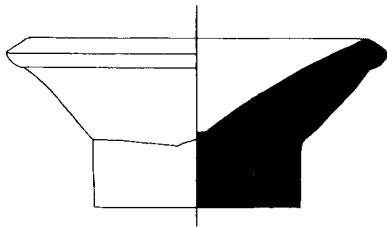

G 6044X: 25-12-296

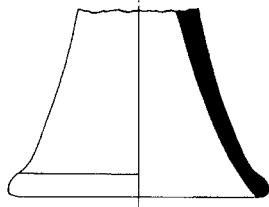
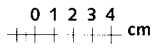

G 6044X: 25-12-297

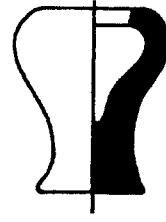

G 6050: 25-11-146

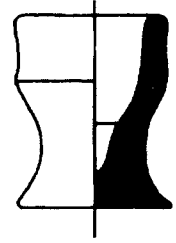

G 6050: 25-11-145

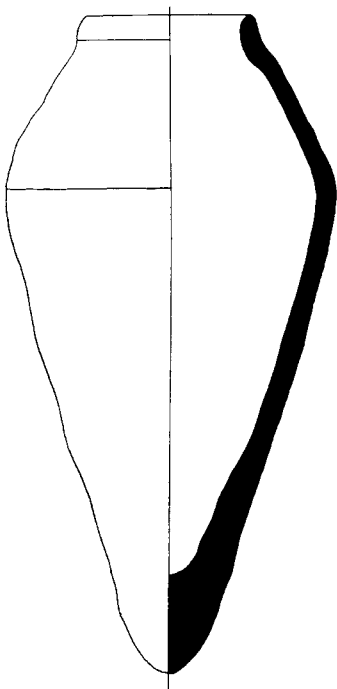
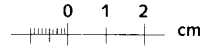

G 6050: 25-11-143

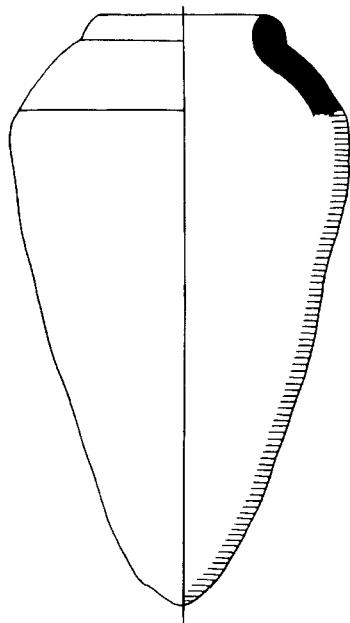

G 6050: 25-11-148

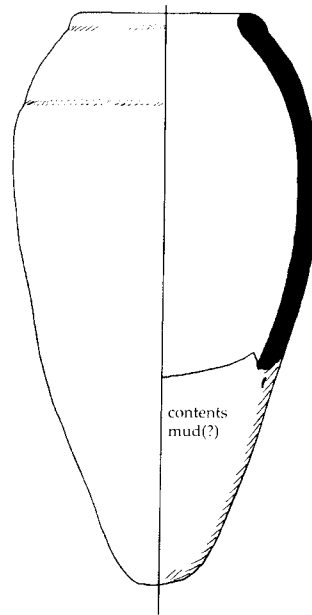
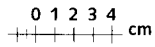

G 6050: 25-11-137

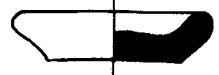

G 6050: 25-11-142a



G 6050: 25-11-142b



G 6050: 25-11-142c

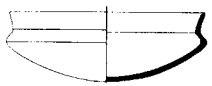

G 6051A: 25-12-139

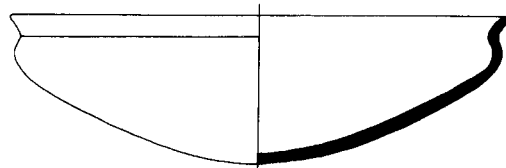

G 6052B: 25-12-685

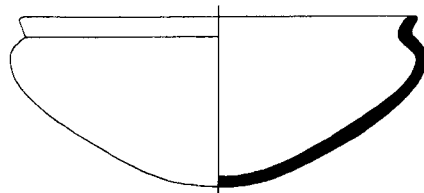

G 6052B: 25-12-680

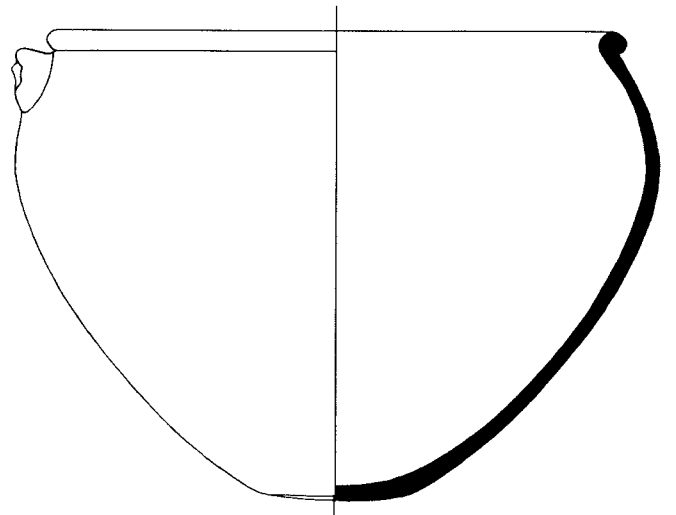

G 6052B: 25-12-674

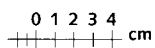

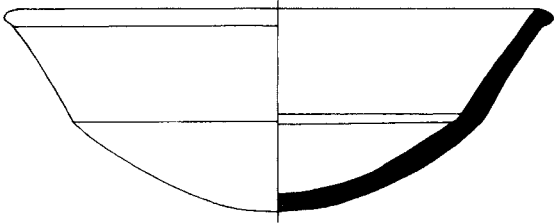

G 6052B: 25-12-677

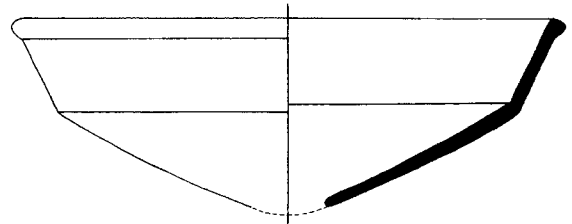

G 6052B: 25-12-690

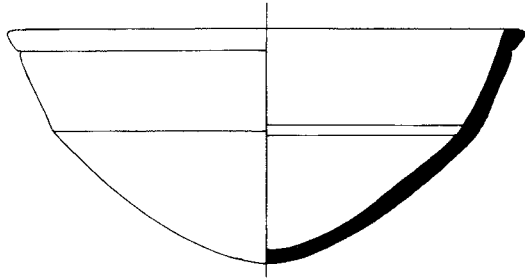

G 6052B: 25-12-676

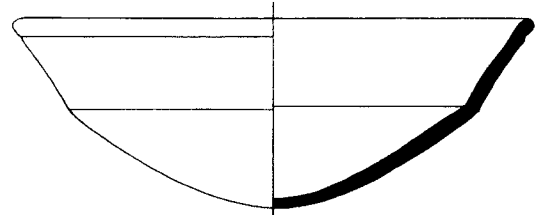

G 6052B: 25-12-697

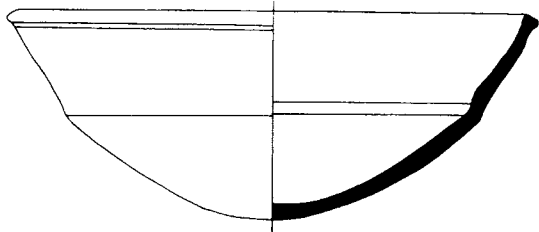

G 6052B: 25-12-678

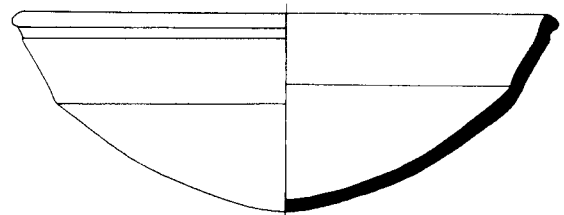

G 6052B: 25-12-679

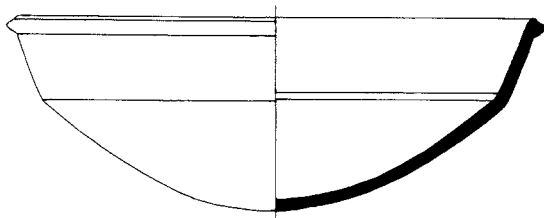

G 6052B: 25-12681

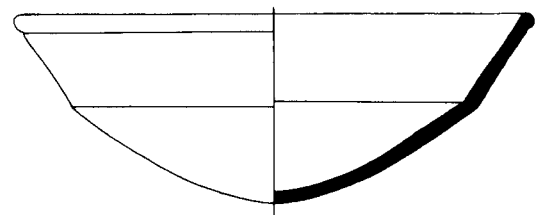

G 6040: 25-12-269

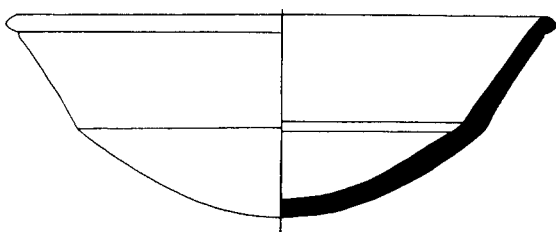

G 6052B: 25-12-699

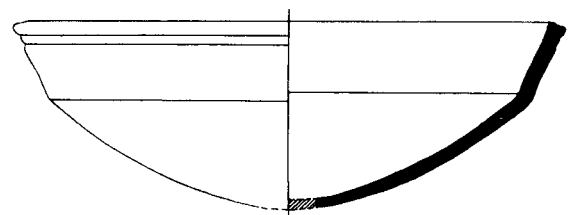

G 6052B: 25-12-698

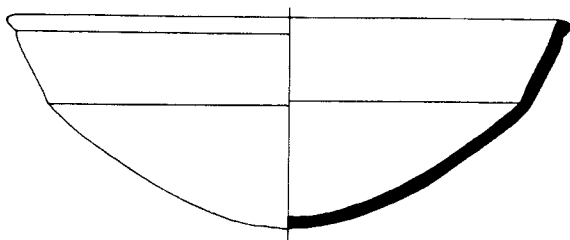

G 6052B: 25-12-688

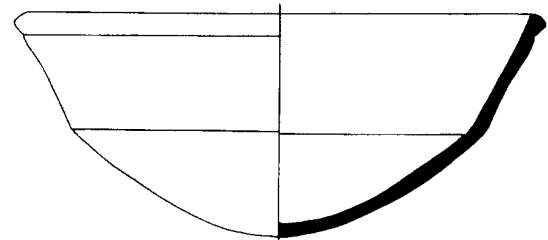

G 6052B: 25-12-683

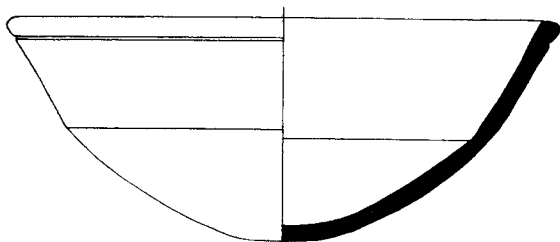

G 6052B: 25-12-675

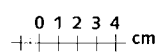

133. Pottery from G 6052
(actual vessels unavailable for redrawing)

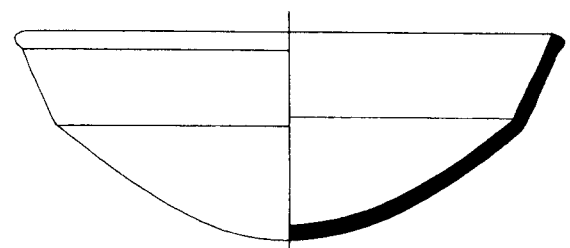

G 6052B: 25-12-696

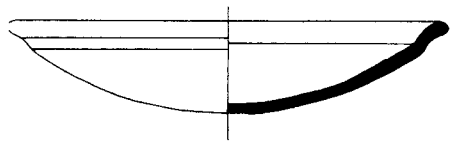

G 605B2: 25-12-682

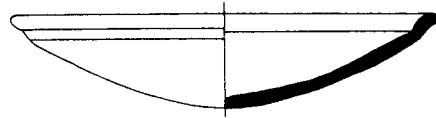

G 6052B: 25-12-691



G 6052B: 25-12-684

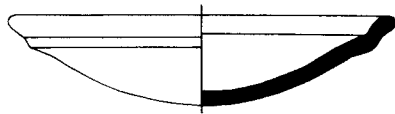

G 6052B: 25-12-689

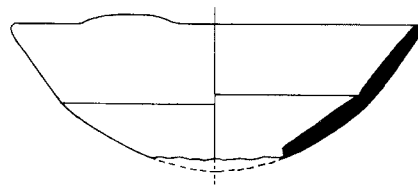

G 6052B: 25-12-695

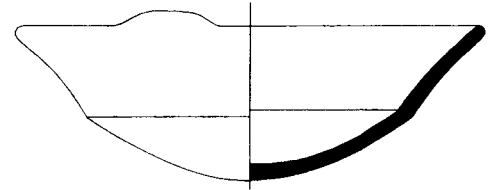

G 6052B: 25-12-694

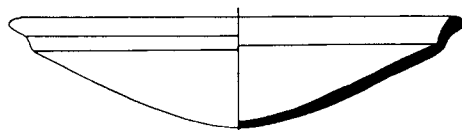

G 6052B: 25-12-686

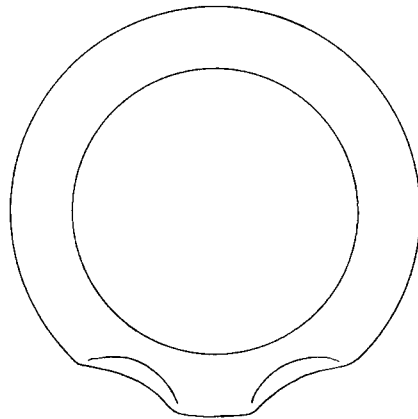

G 6052B: 25-12-692

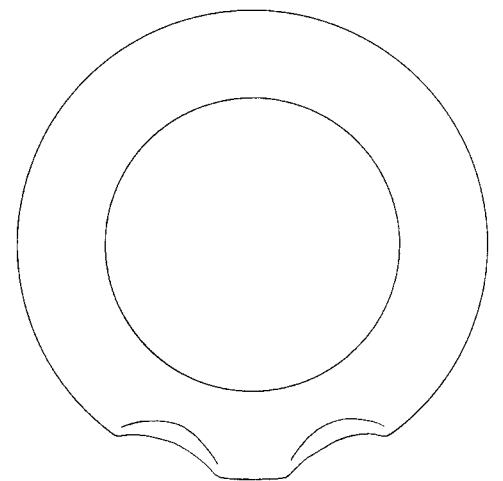

G 6052B: 25-12-693

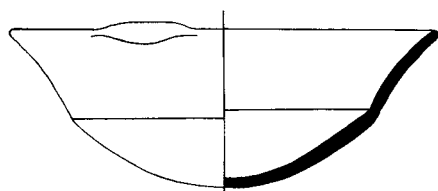

G 6052B: 25-12-687

