



128a. 2240: south wall. Herdsmen driving cattle (a 8241)



128b. 2240: east wall, south. Nefer-mesdjer-Khufu watching work in the fields (a 8244)



129a. 2240: east wall, north. Work in the wheat fields (a 8245)

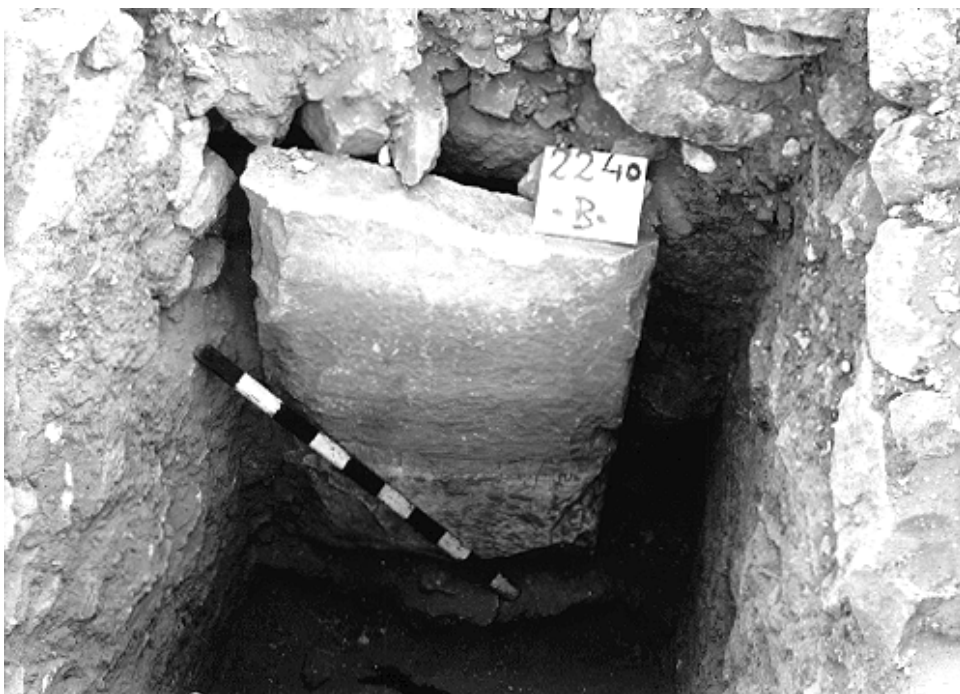

129b. 2240 b: blocking type v e+, a leaning slab resting on rubble bound with mud (b 9147)

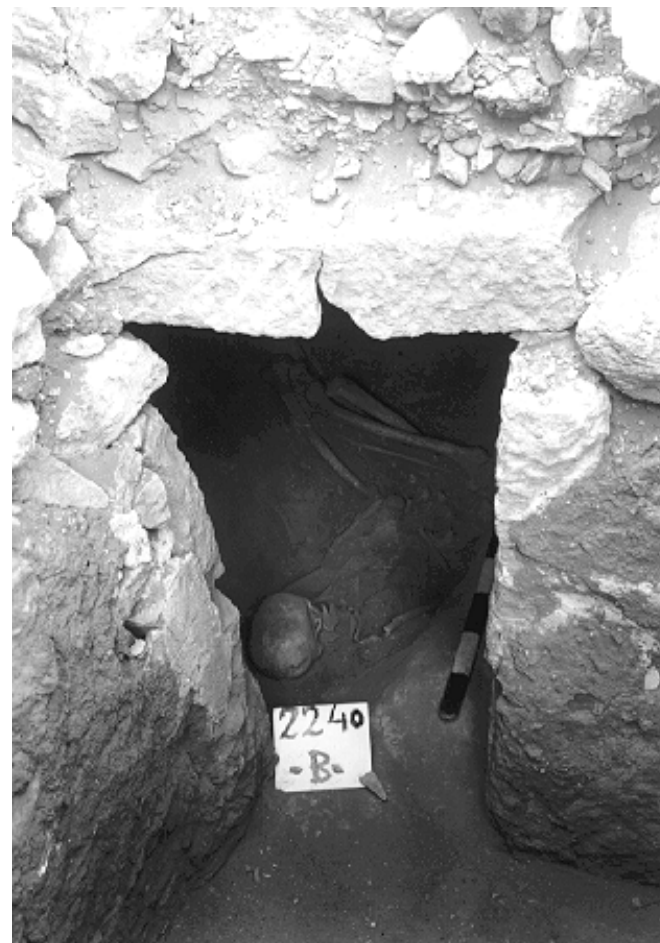

129c. 2240 b: a skeletally adult burial lying in a shallow burial pit in the floor of the chamber (b 9156)



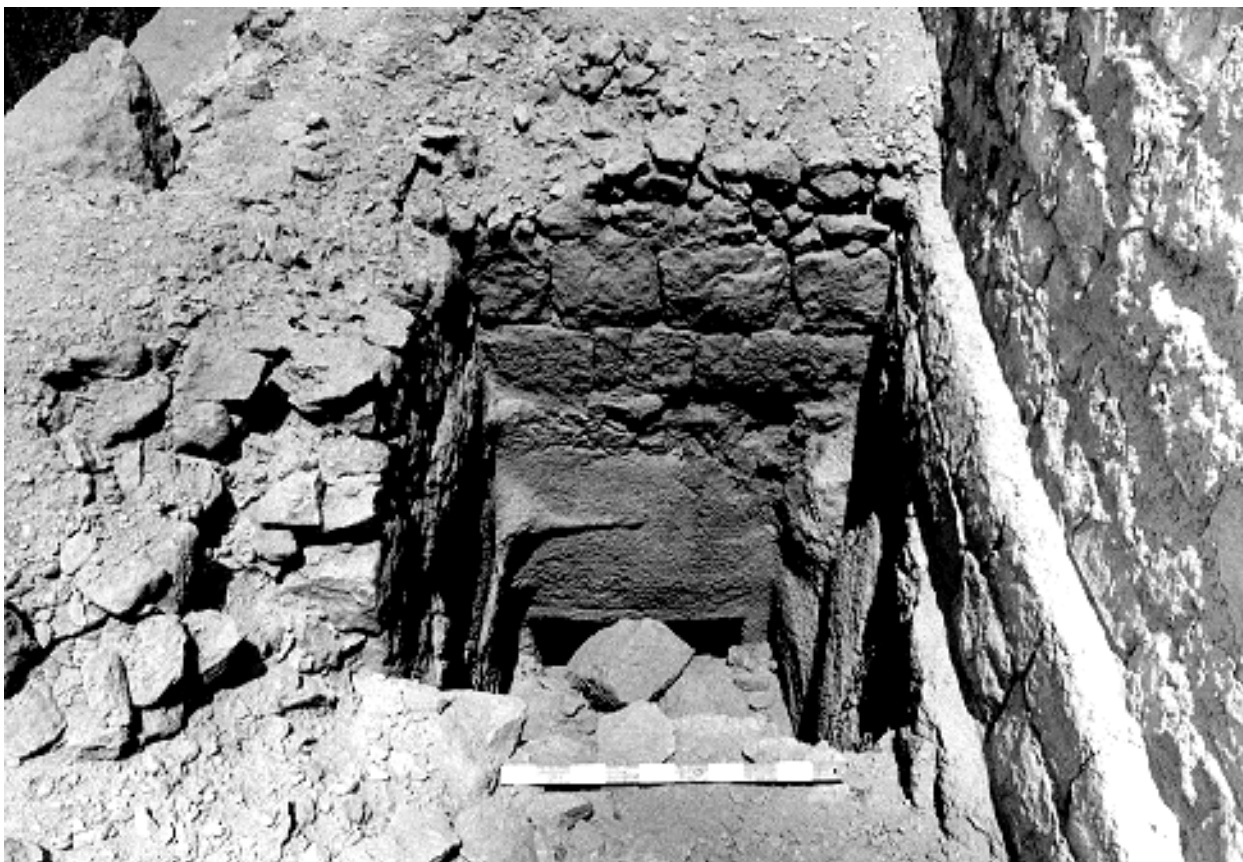

130a. 2240 a: shaft from its top, showing construction and top of entrance to burial chamber (rg 9-19, 1989)



130b. Part of head, from debris on top of 2230, but possibly originally from 2240 serdab. 39-2-7 (b 9058)

130c. Model figure of a man, perhaps playing a harp. Found south of 2230+2231. 39-4-1 (b 9110, left)

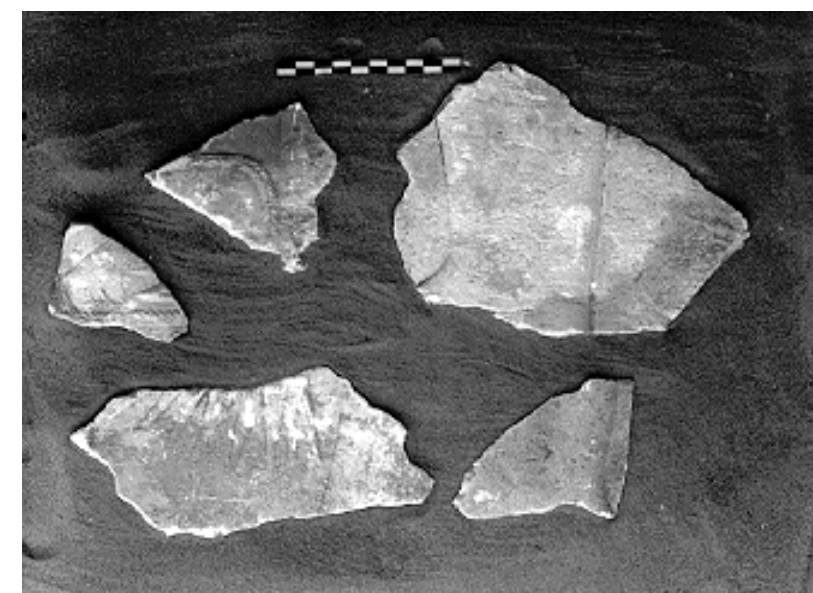

130d. Displaced fragments of relief (some probably of the Fourth Dynasty) from the top of 2230+2231 (c 14270)

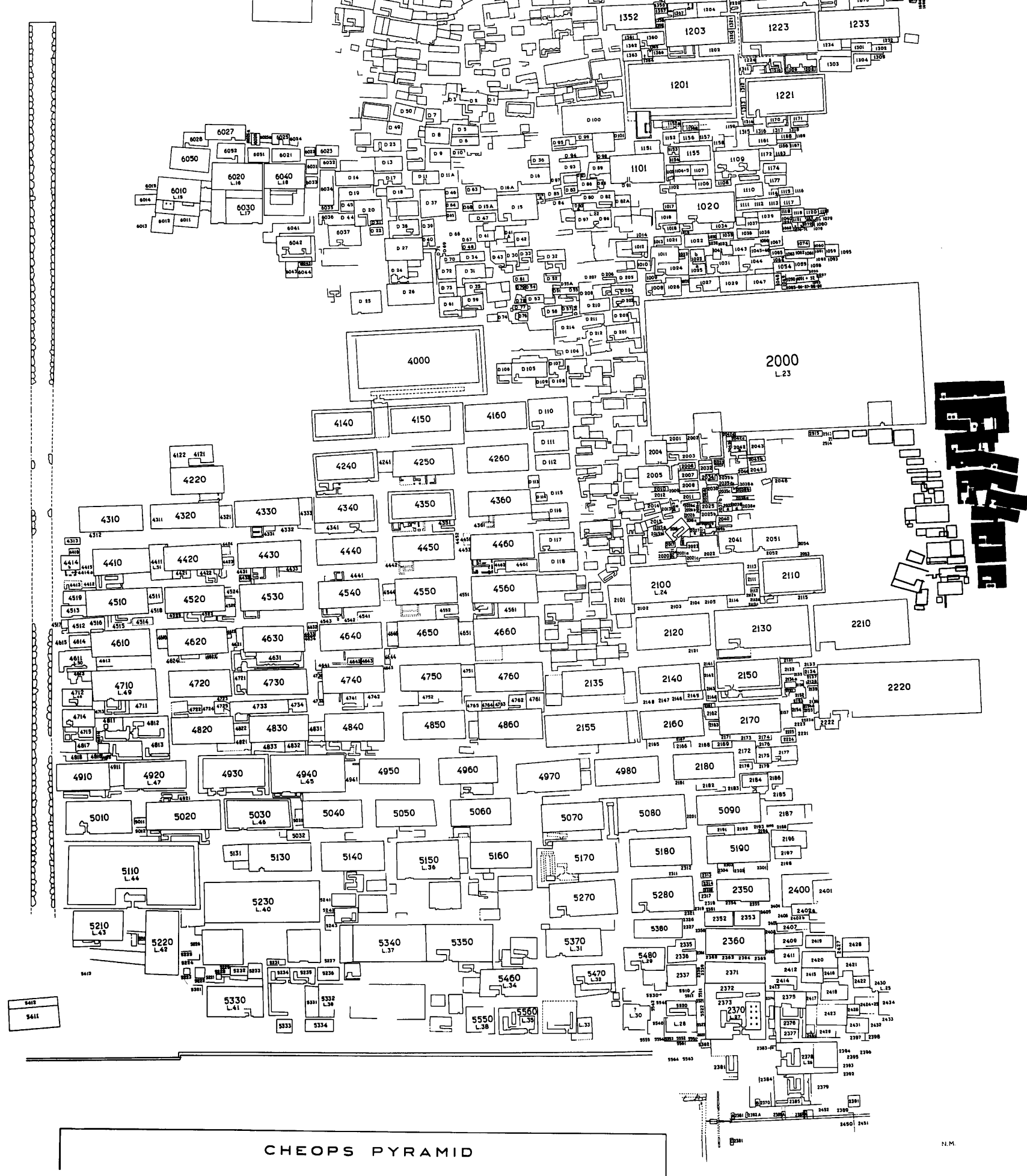

131. Plan of the Western Cemetery at Giza showing the cluster of tombs of palace attendants

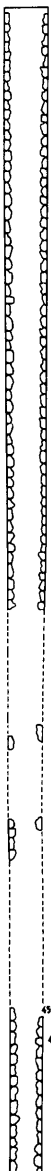
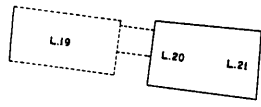
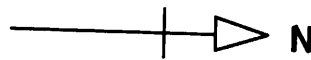
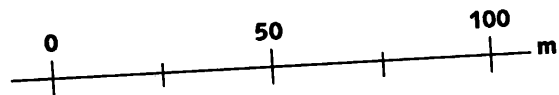

1845  
1846  
1847  
1848  
1849  
1850  
1851  
1852  
1853  
1854  
1855  
1856  
1857  
1858  
1859  
1860  
1861  
1862  
1863  
1864  
1865  
1866  
1867  
1868  
1869  
1870  
1871  
1872  
1873  
1874  
1875  
1876  
1877  
1878  
1879  
1880  
1881  
1882  
1883  
1884  
1885  
1886  
1887  
1888  
1889  
1890  
1891  
1892  
1893  
1894  
1895  
1896  
1897  
1898  
1899  
1900

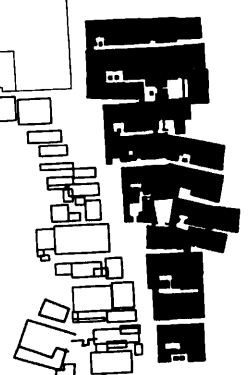

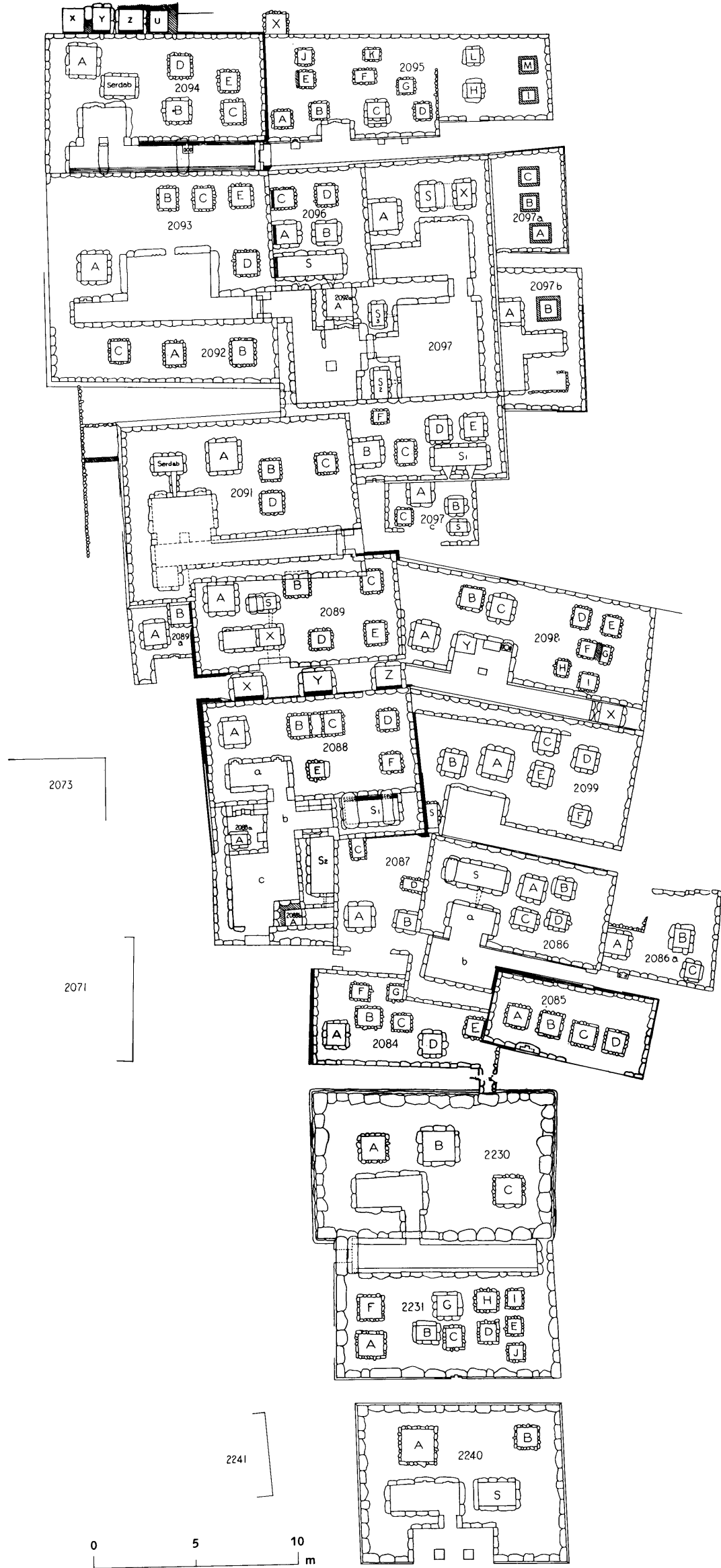

132. The Floroff plan of the cluster

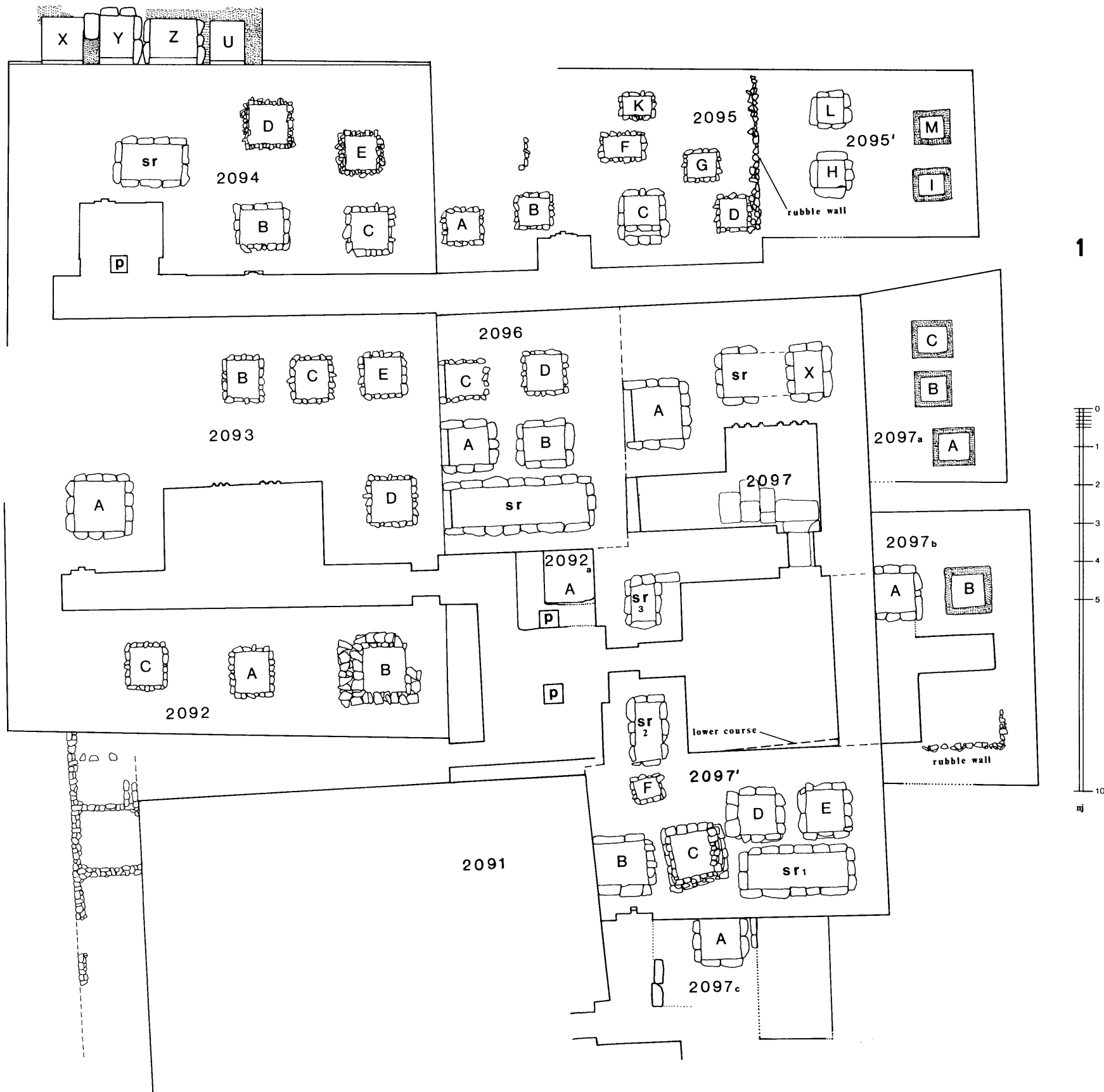

1

133. The 1990 revised plan of the cluster, western end

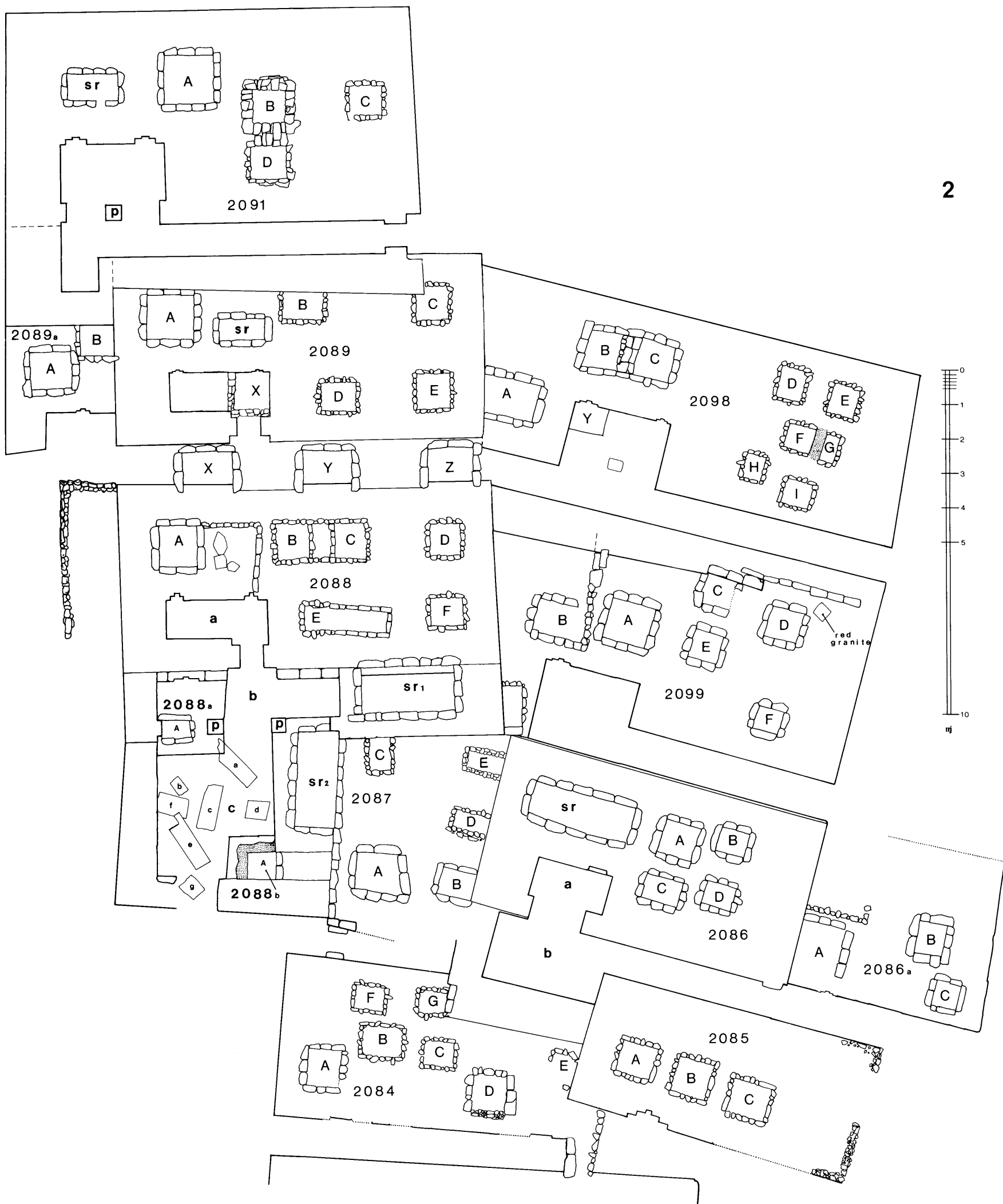

134. The 1990 revised plan of the cluster, center part



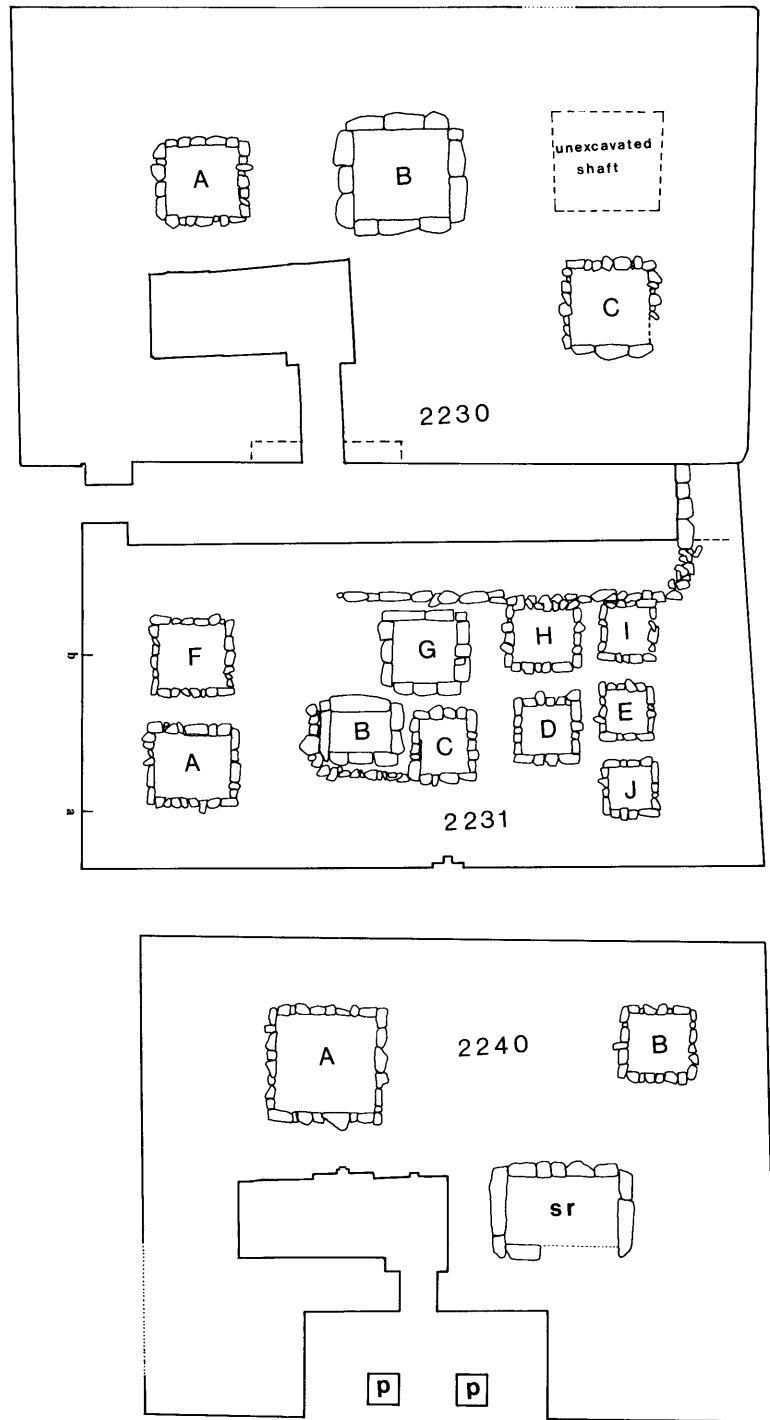

3

135. The 1990 revised plan of the cluster, eastern end

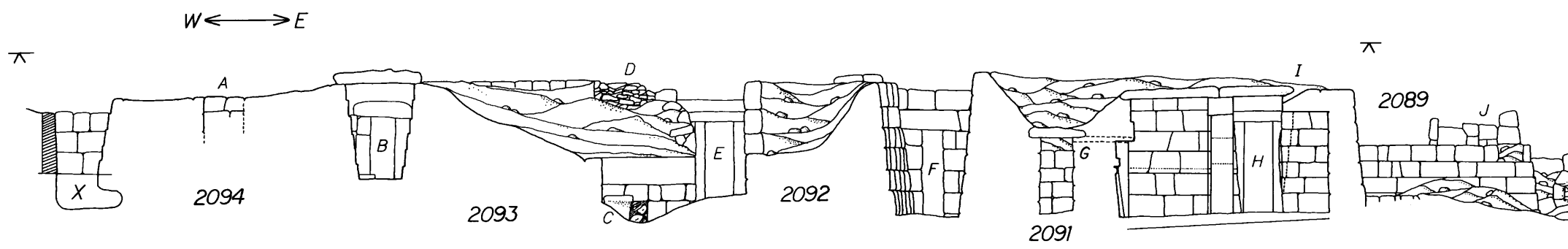

136. East-west section of the cluster. (See p. 9)

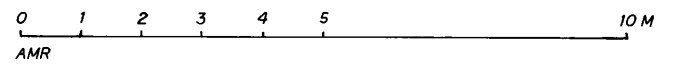
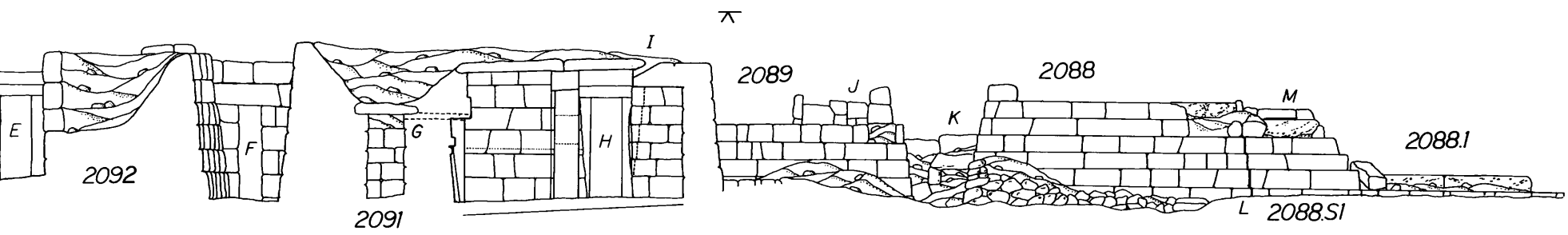

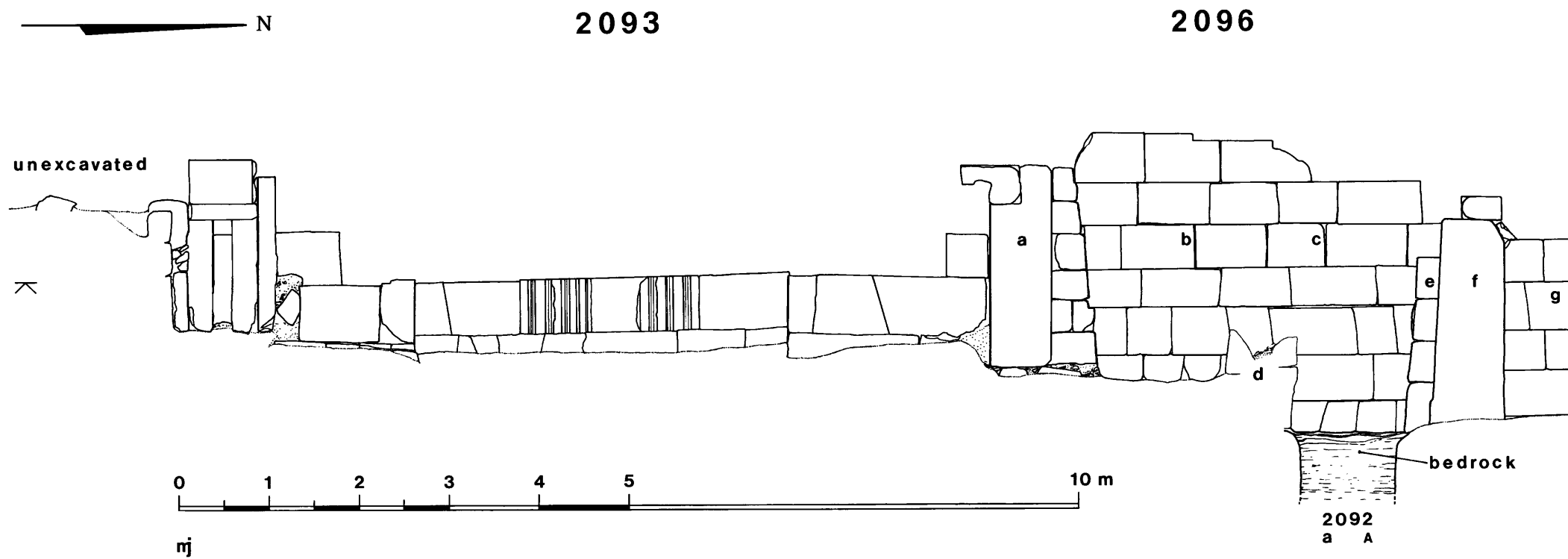

137. North-south section of the cluster, with elevations of the remains of 2092a. (See pp. 8-9)

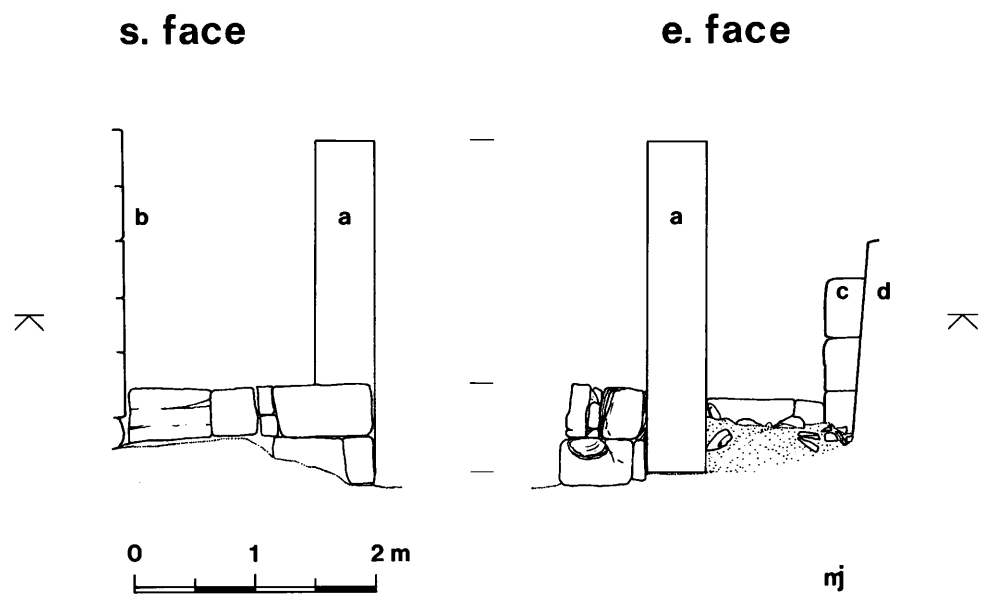

2096

2097

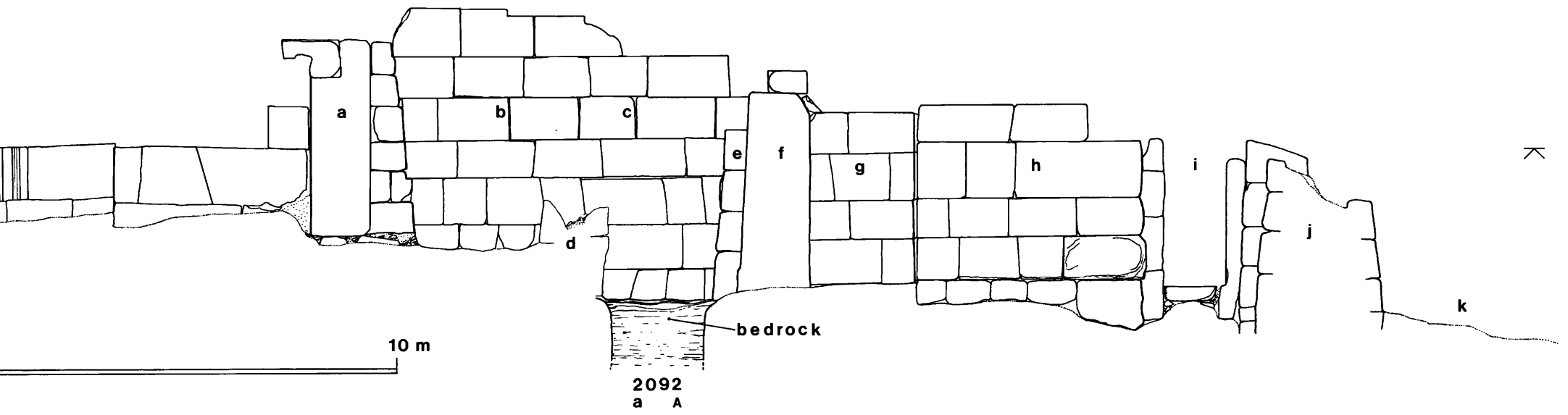

f 2092a. (See pp. 8-9)

e. face

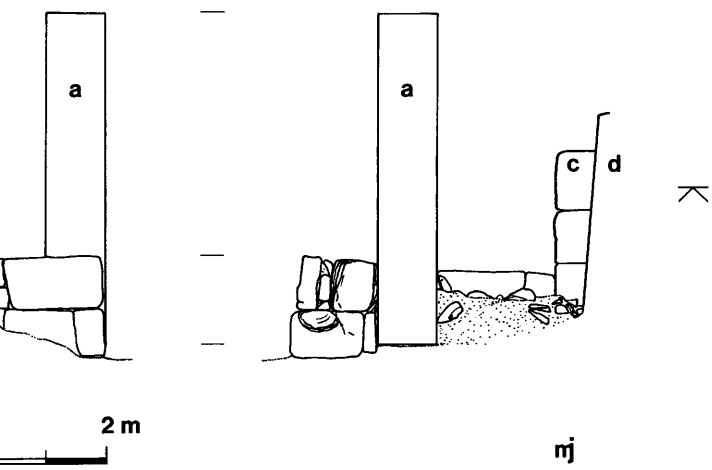



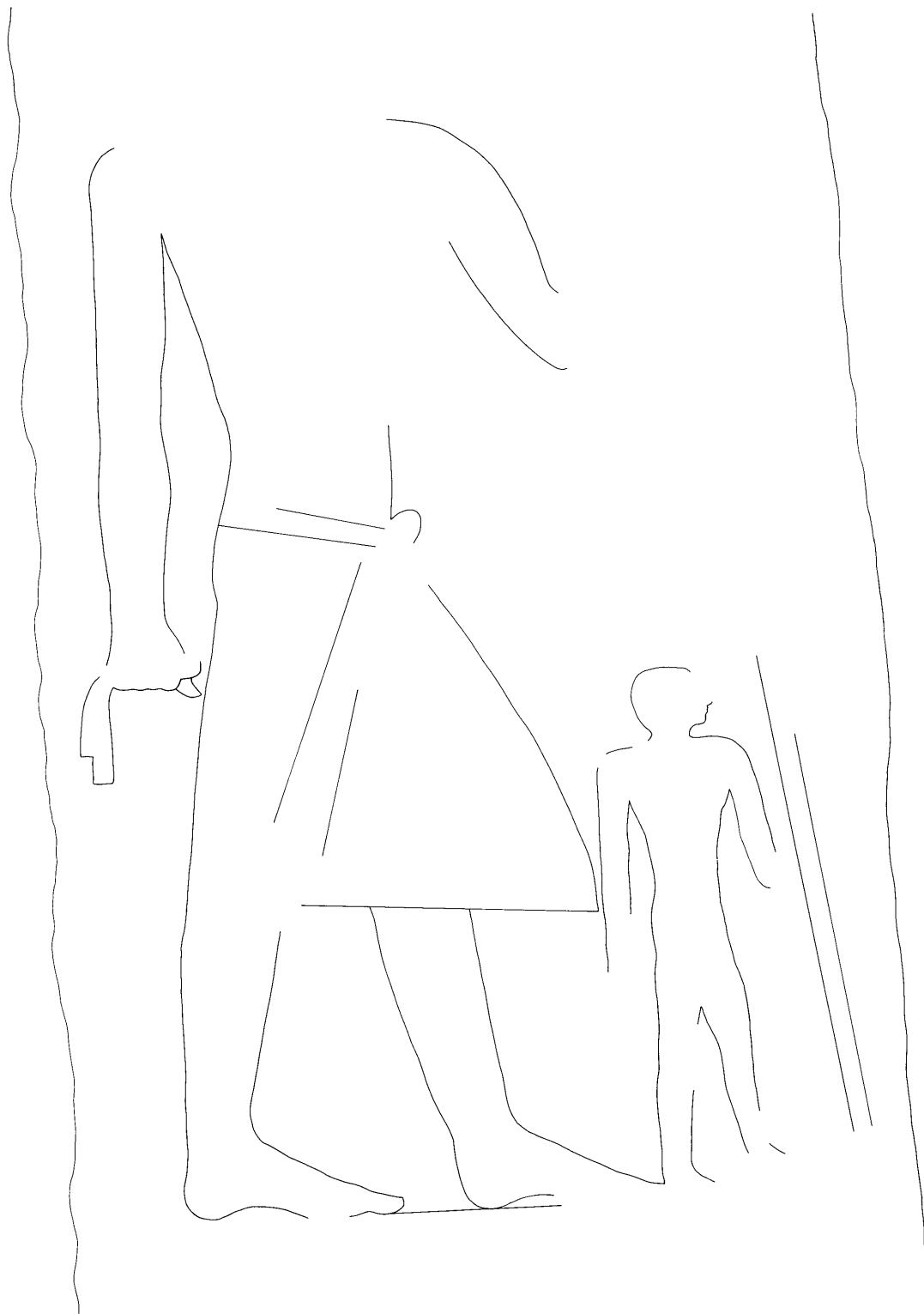

138. 2086: West jamb of northern doorway to entrance corridor

0 5 10  
cm (1:5)

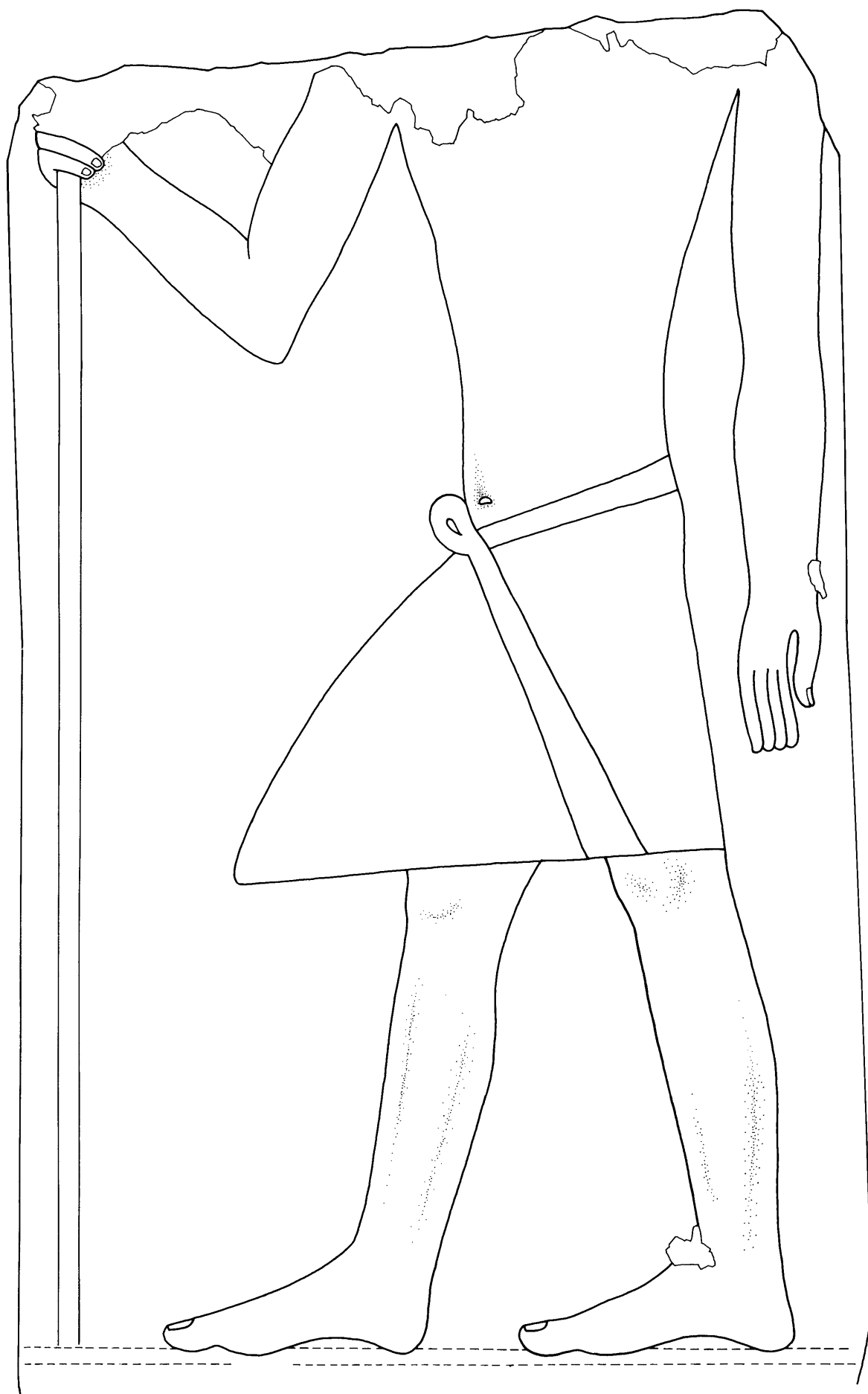

139. 2086: Southern pilaster at entrance to chapel. (See pl. 15)

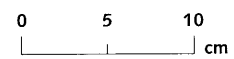

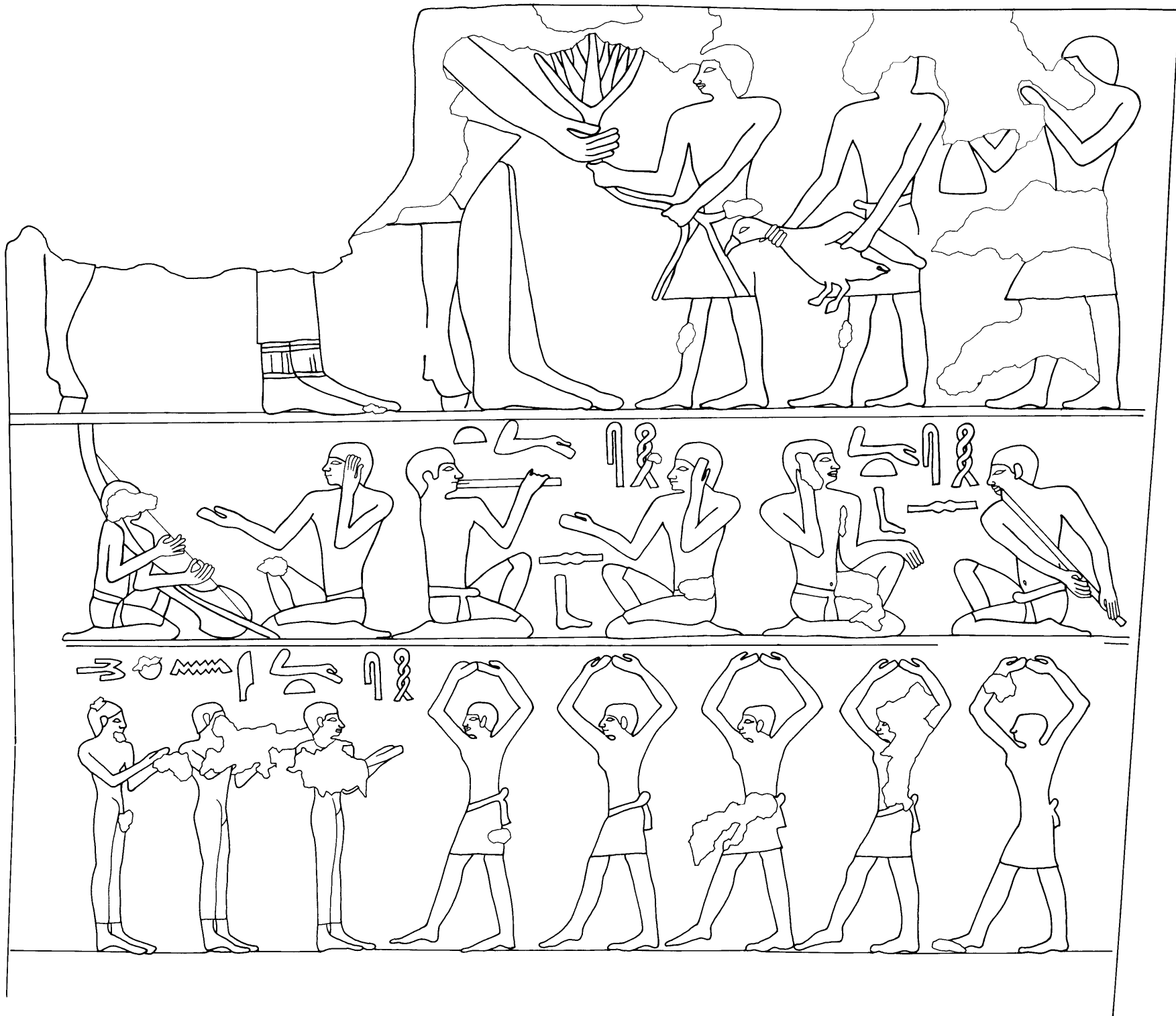

140. 2086: South wall of chapel. (See pl. 16)

0 5 10  
cm

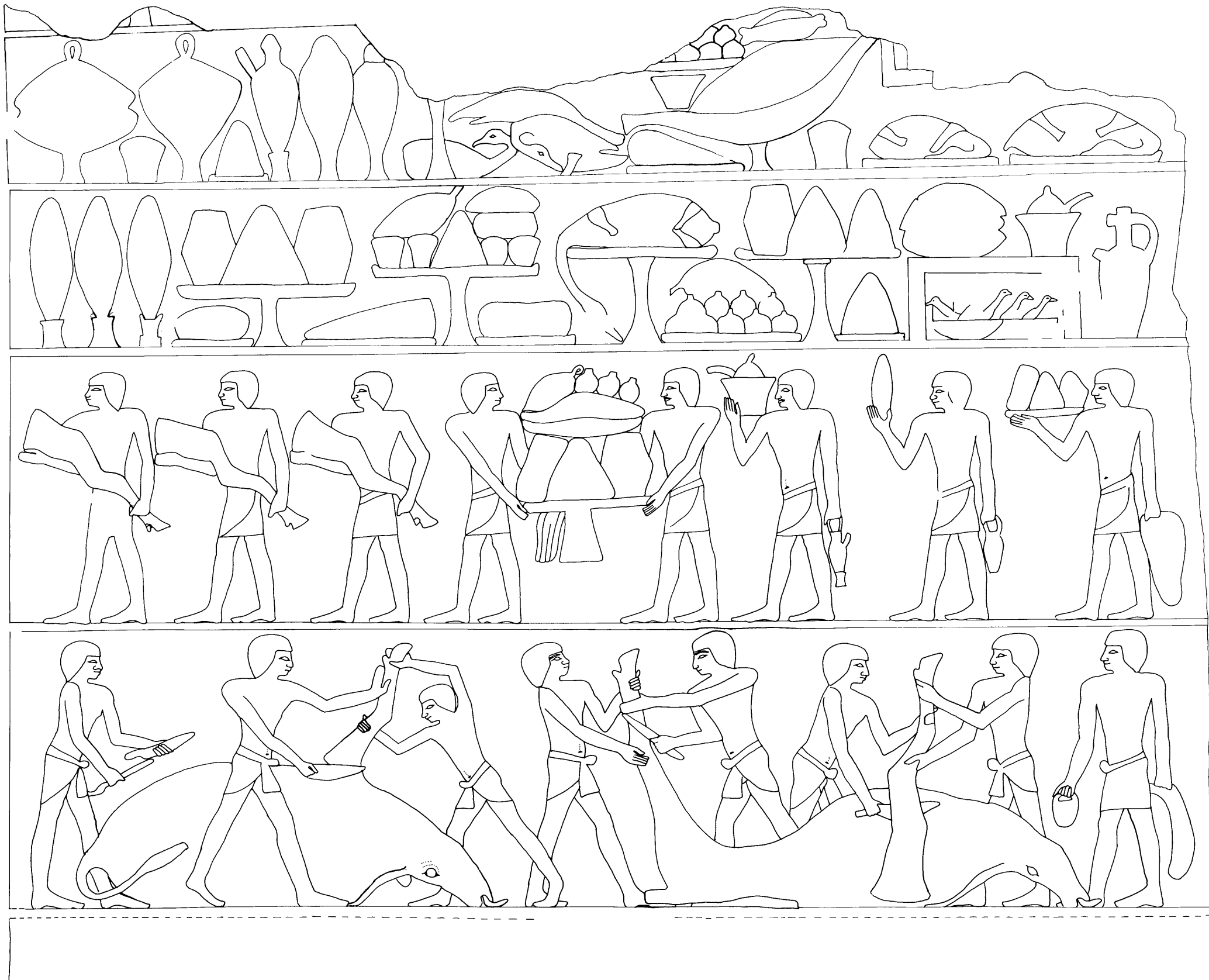

141. 2086: Southern part of west wall of chapel. (See pl. 17)

0 5 10  
cm

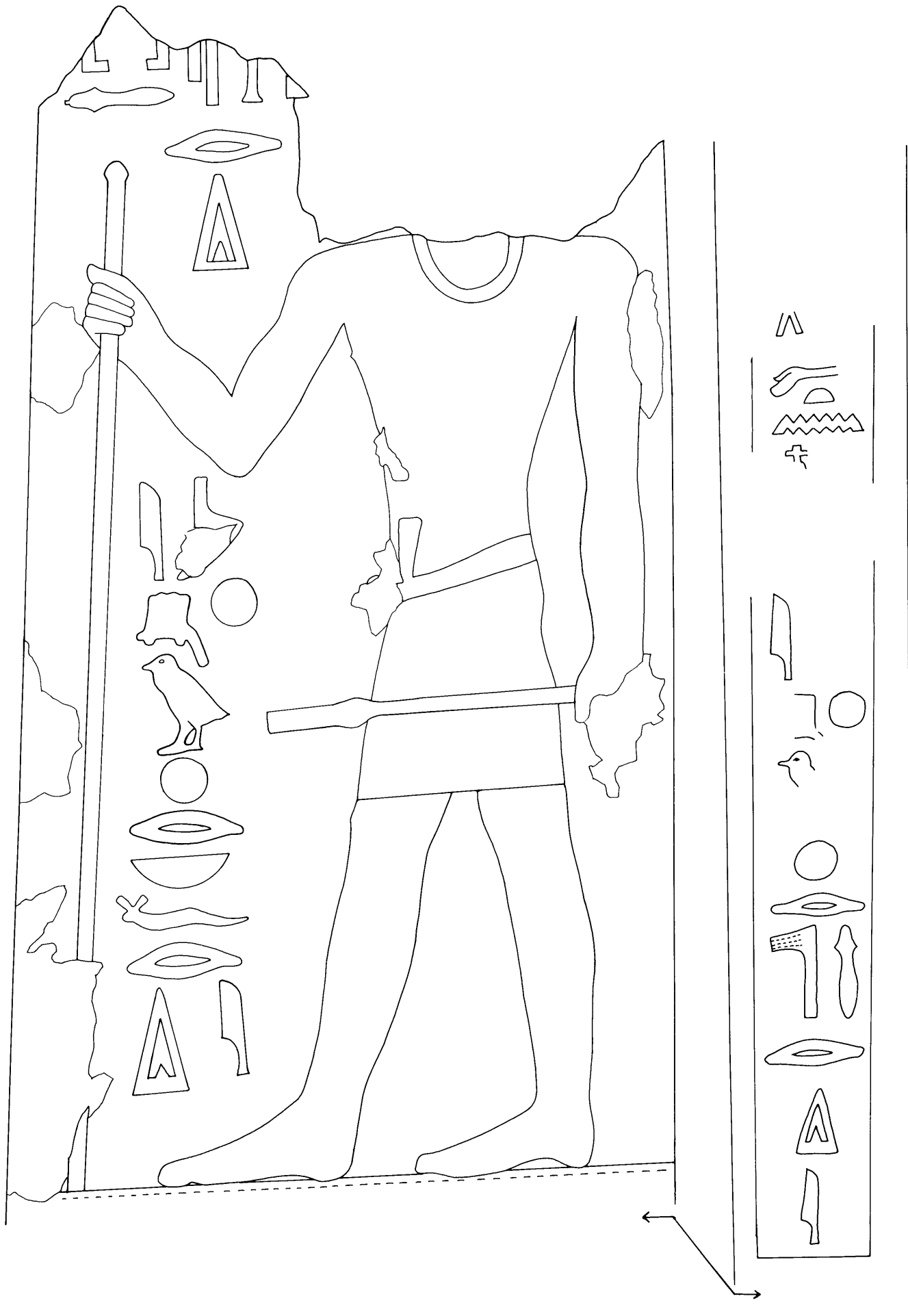

142. 2086: Niche at northern end of west wall of chapel. (See pl. 18a)

0 5 10  
cm



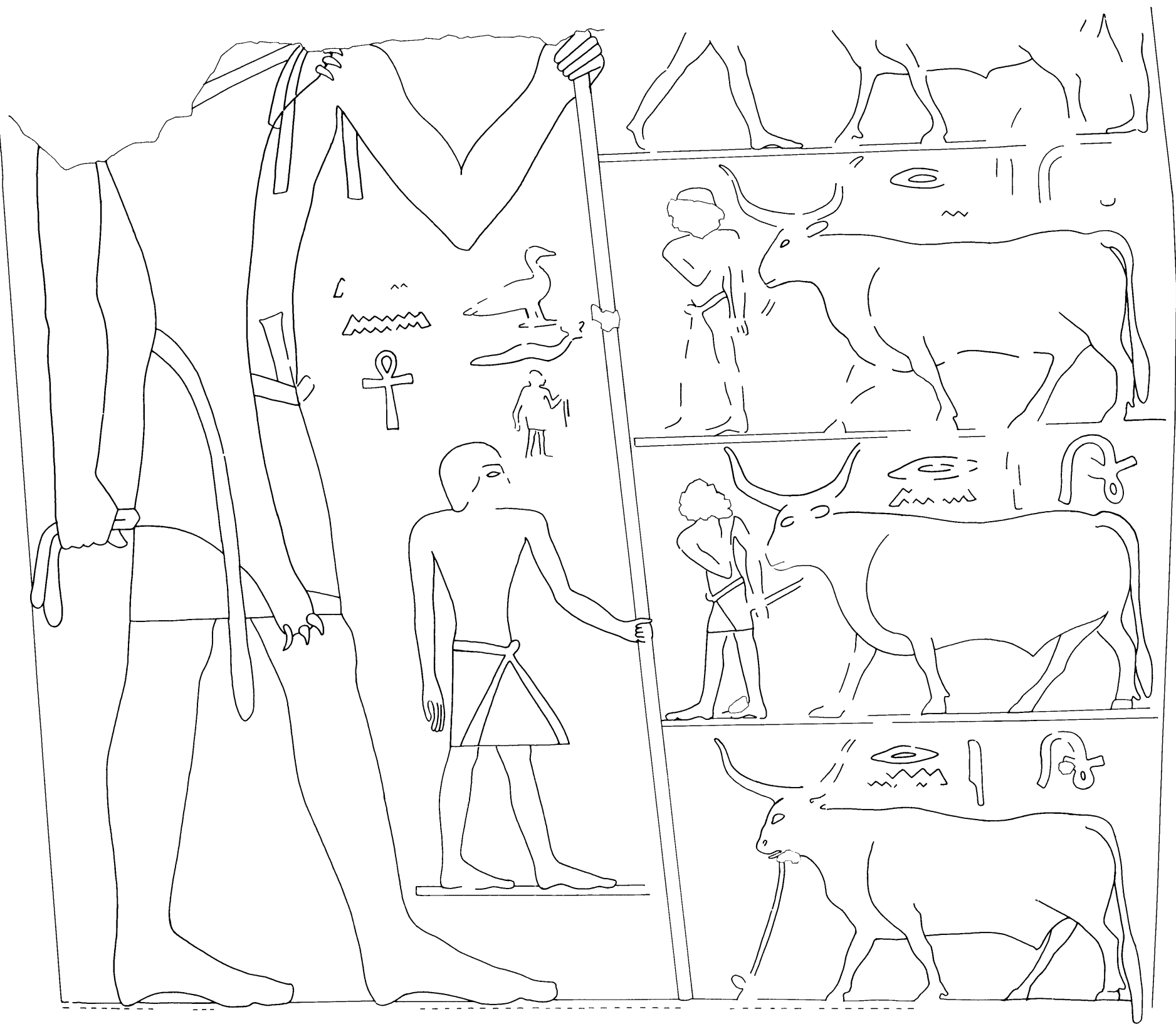

143. 2086: North wall of chapel. (See pl. 18b)

0 5 10  
cm

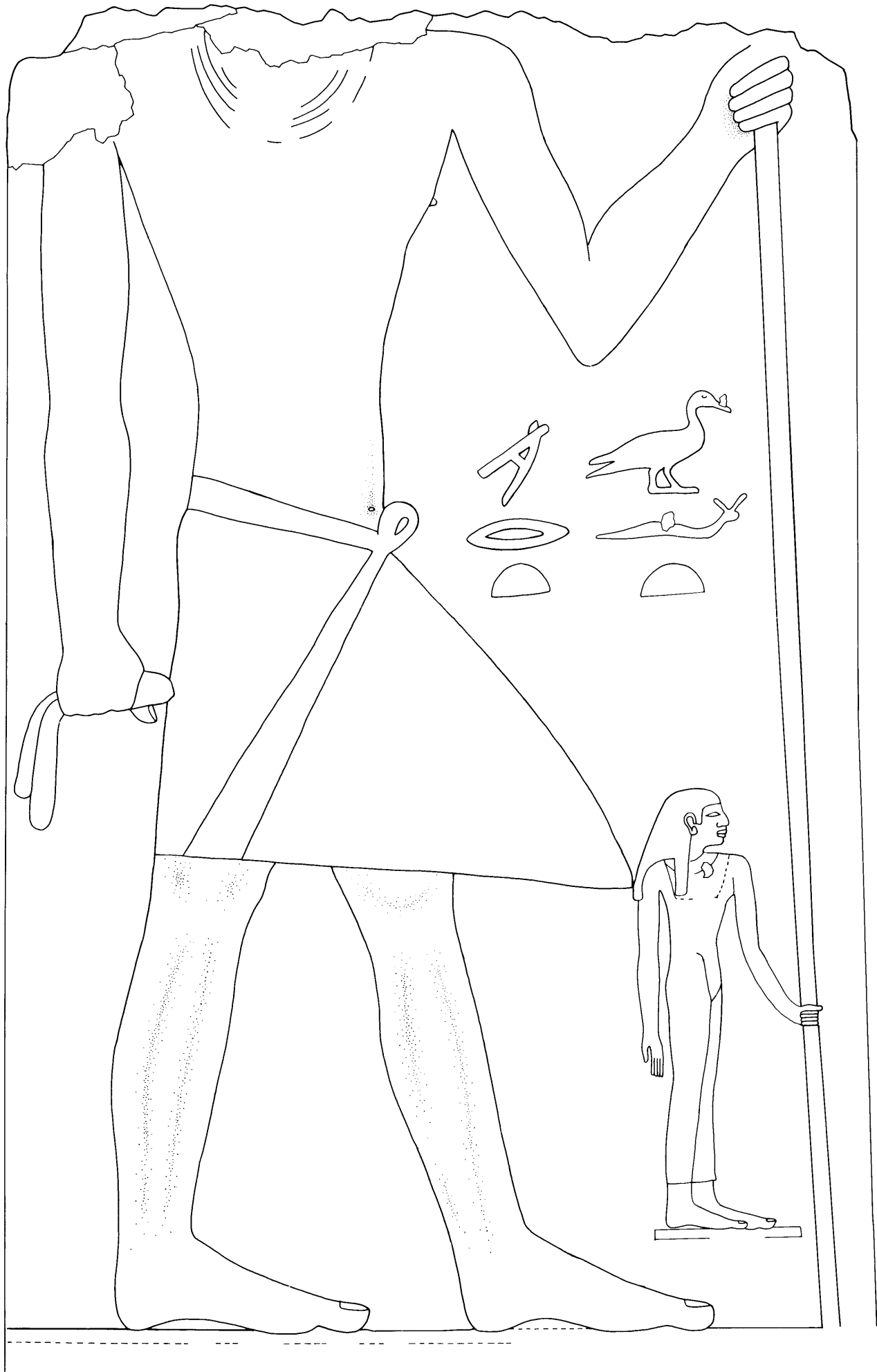

144. 2086: North pilaster at entrance to chapel. (See pl. 19a)

0 5 10  
cm

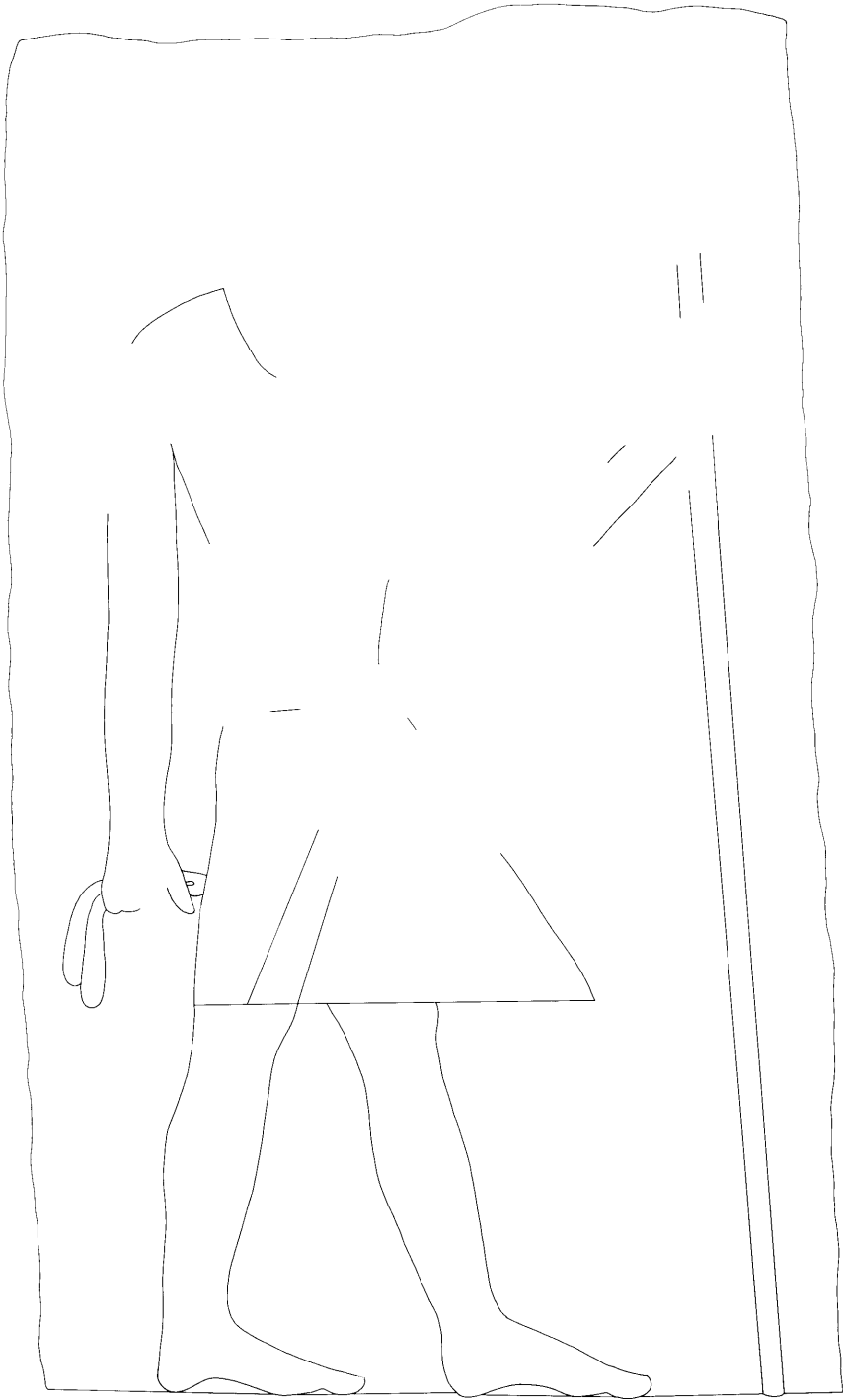

145a, b. 2087: West (right) and east door jambs at southern entrance. (See pl. 23)

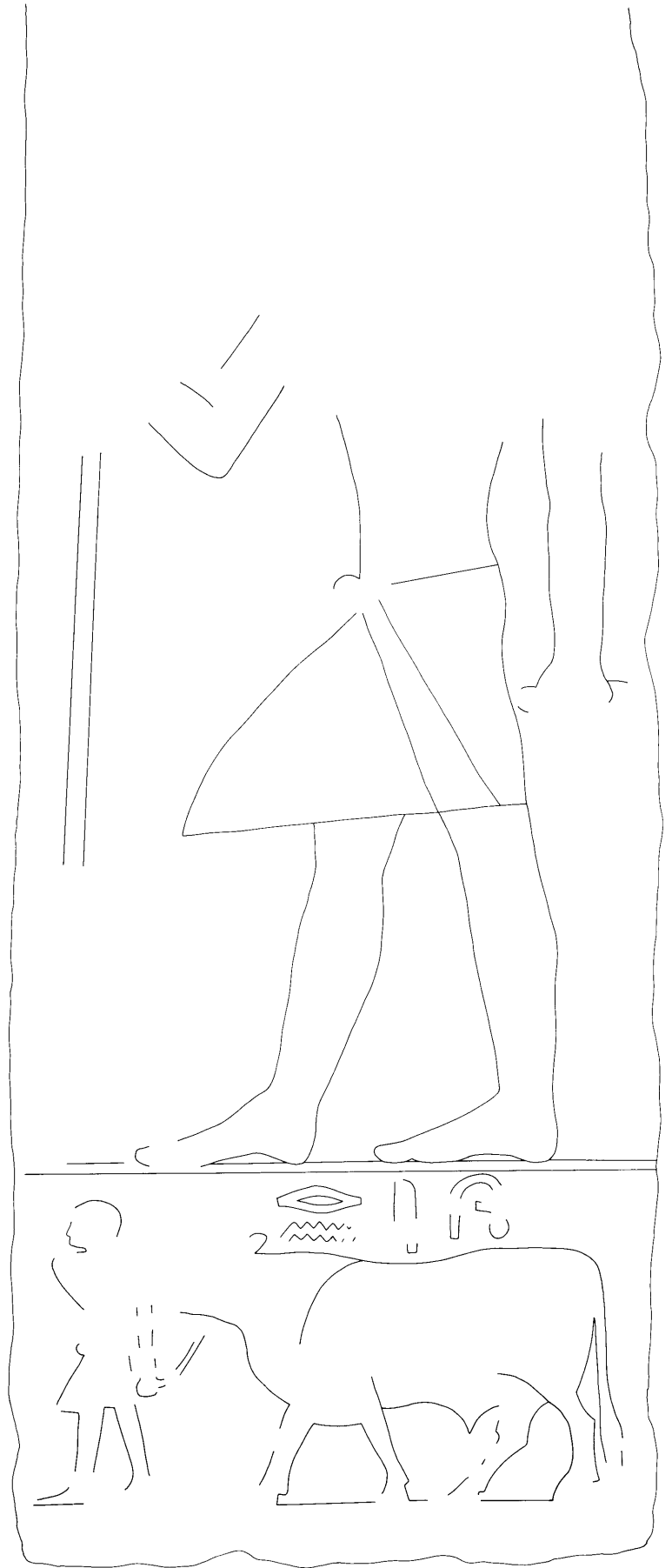

0 5 10  
cm

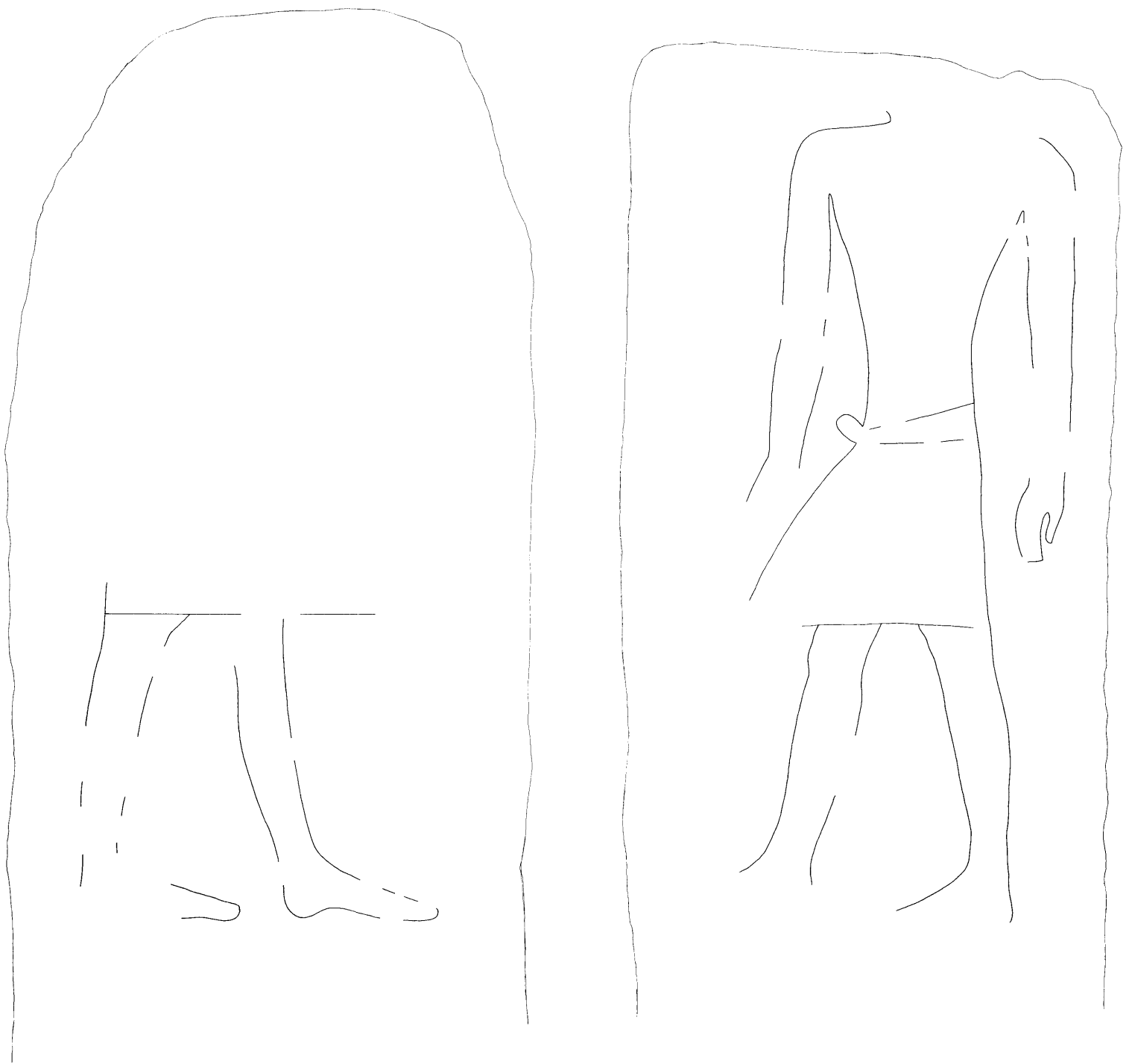
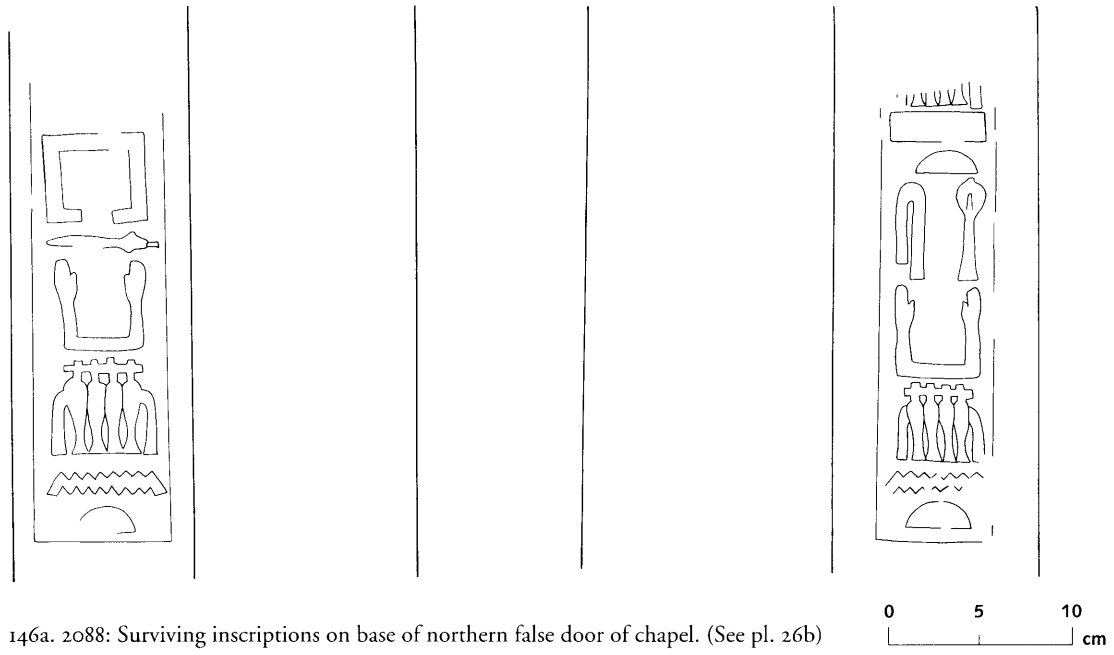

146b. 2088: East faces of pillars of portico

0 5 10 cm (1:5)

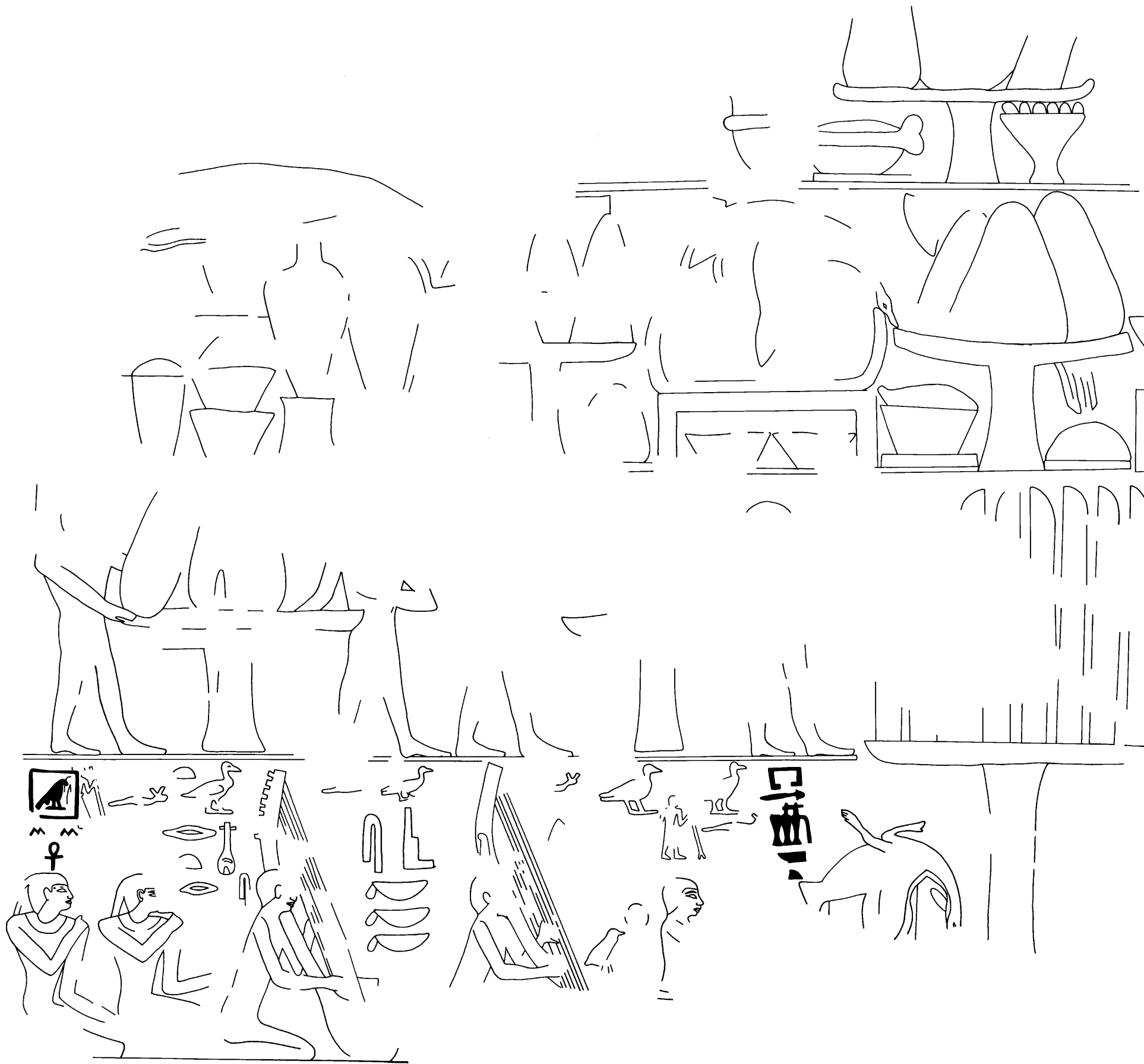

147. 2088: East wall of chapel. (See pl. 28)



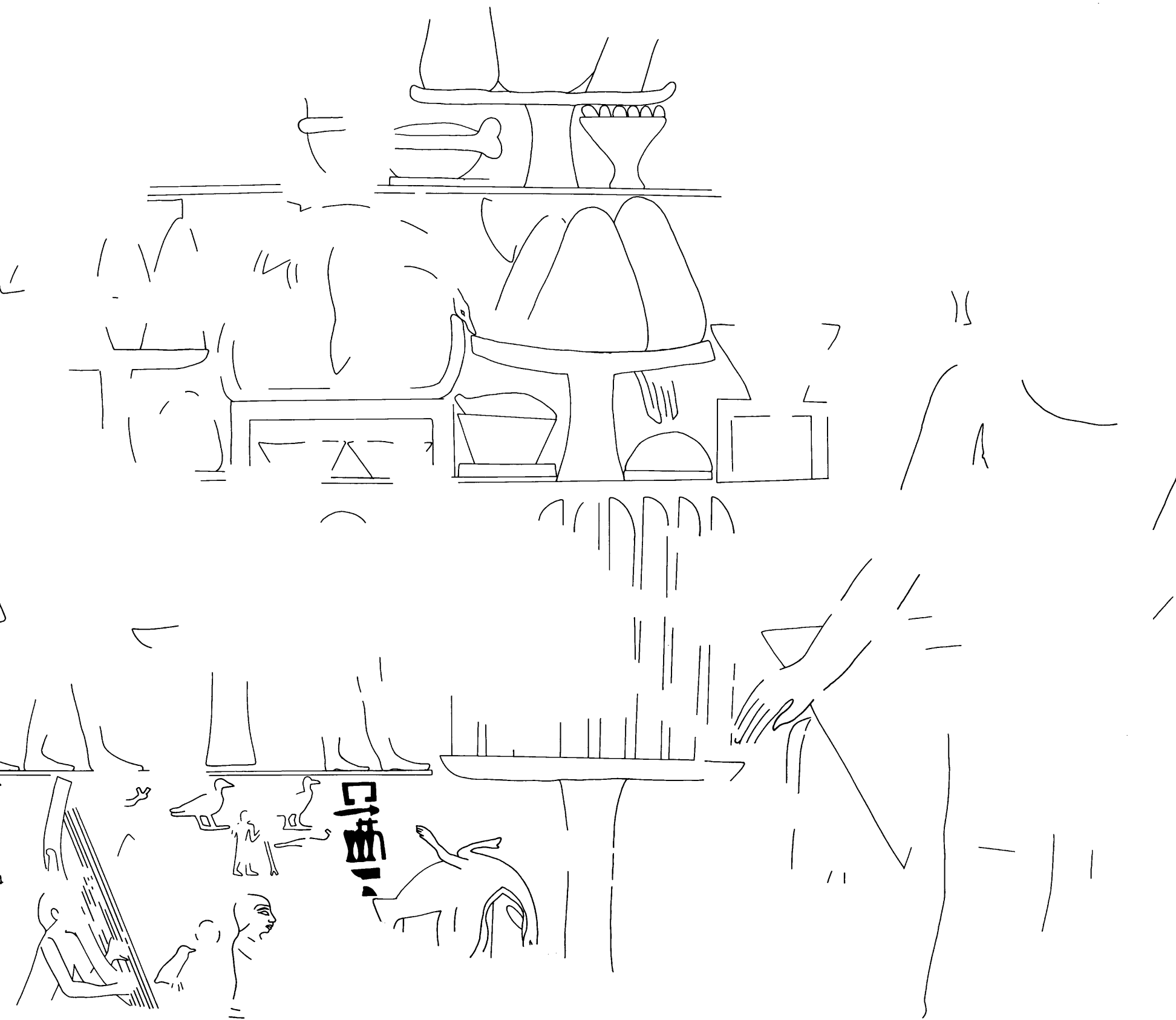

0 5 10  
cm



148. 2088: Reconstructed west wall of chapel. (See pl. 29)



0 5 10  
cm

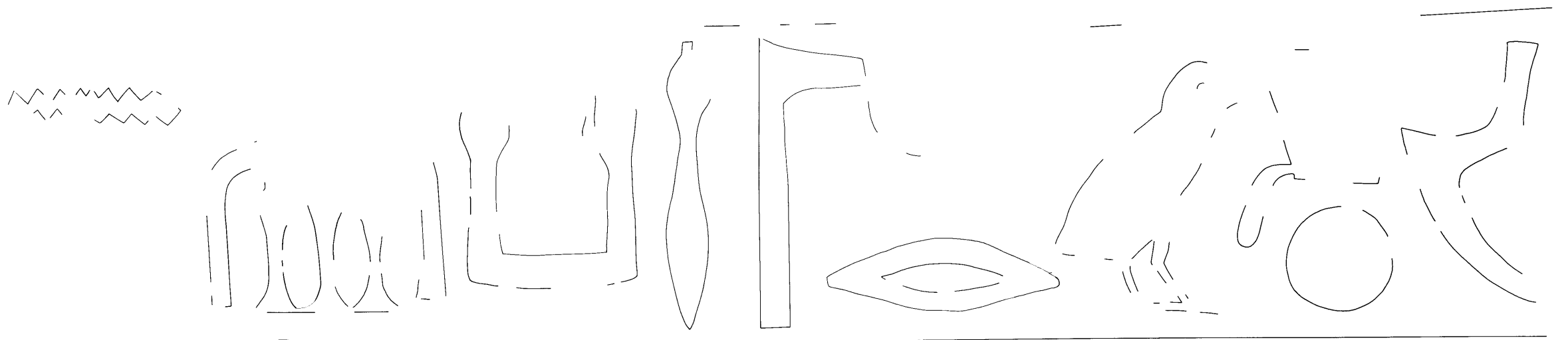

149. 2088: Lintel fragment from portico. (See pl. 30a)

0 5 10  
cm (1:5)

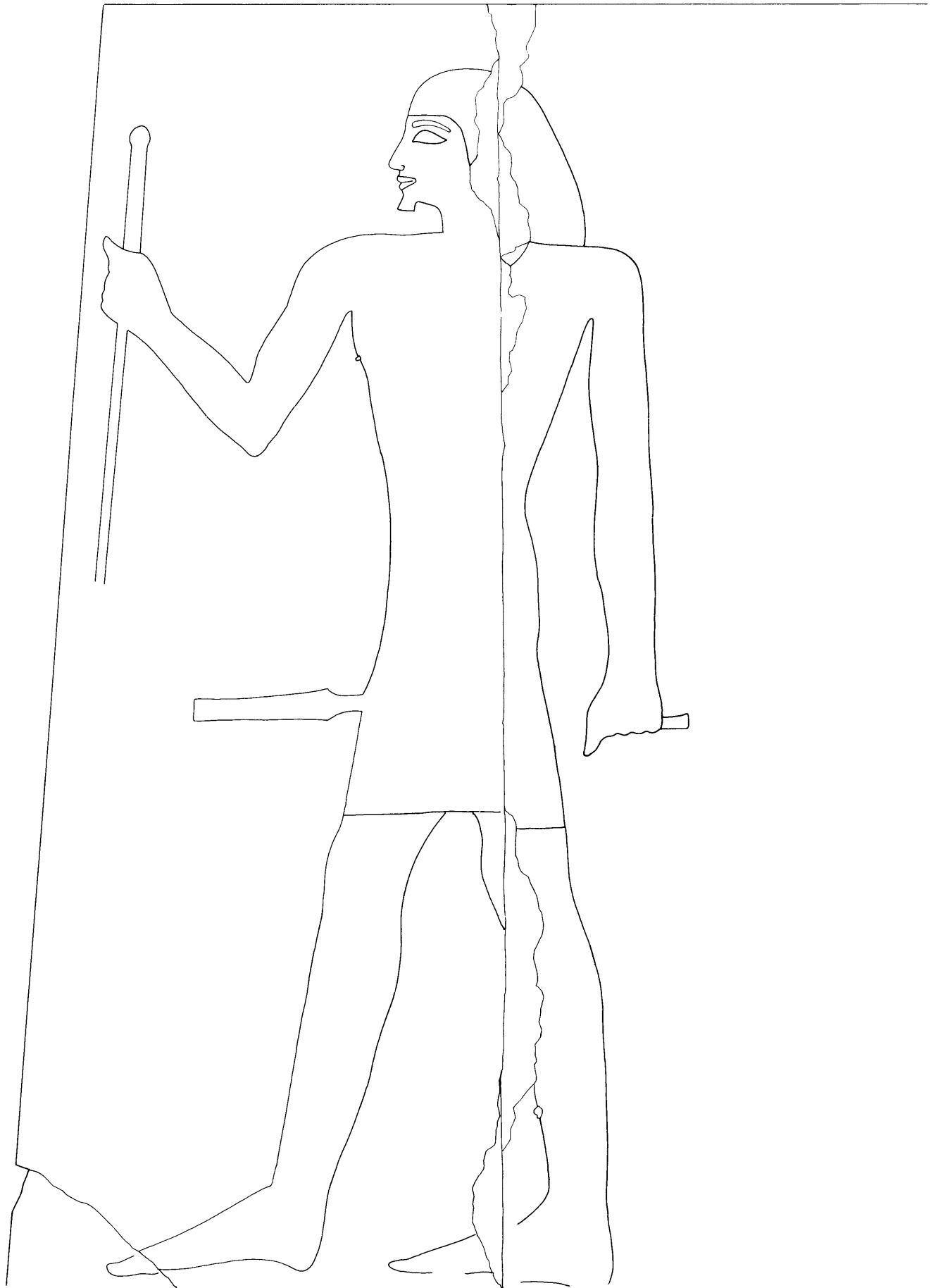

150. 2088: Back wall of portico, north of chapel entrance. (See pl. 30b)

0 5 10  
|-----| cm

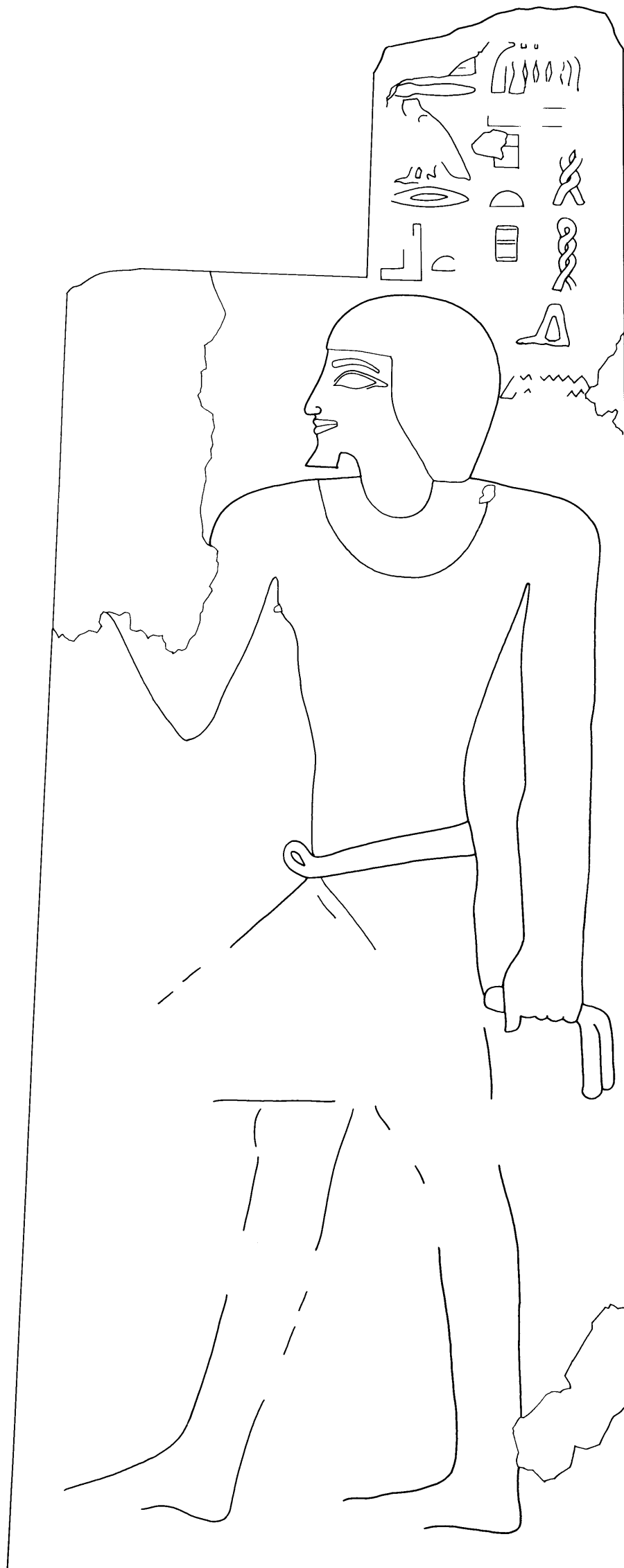

151. 2088: Displaced jamb from eastern entrance to courtyard. (See pl. 31a)

0 5 10  
cm

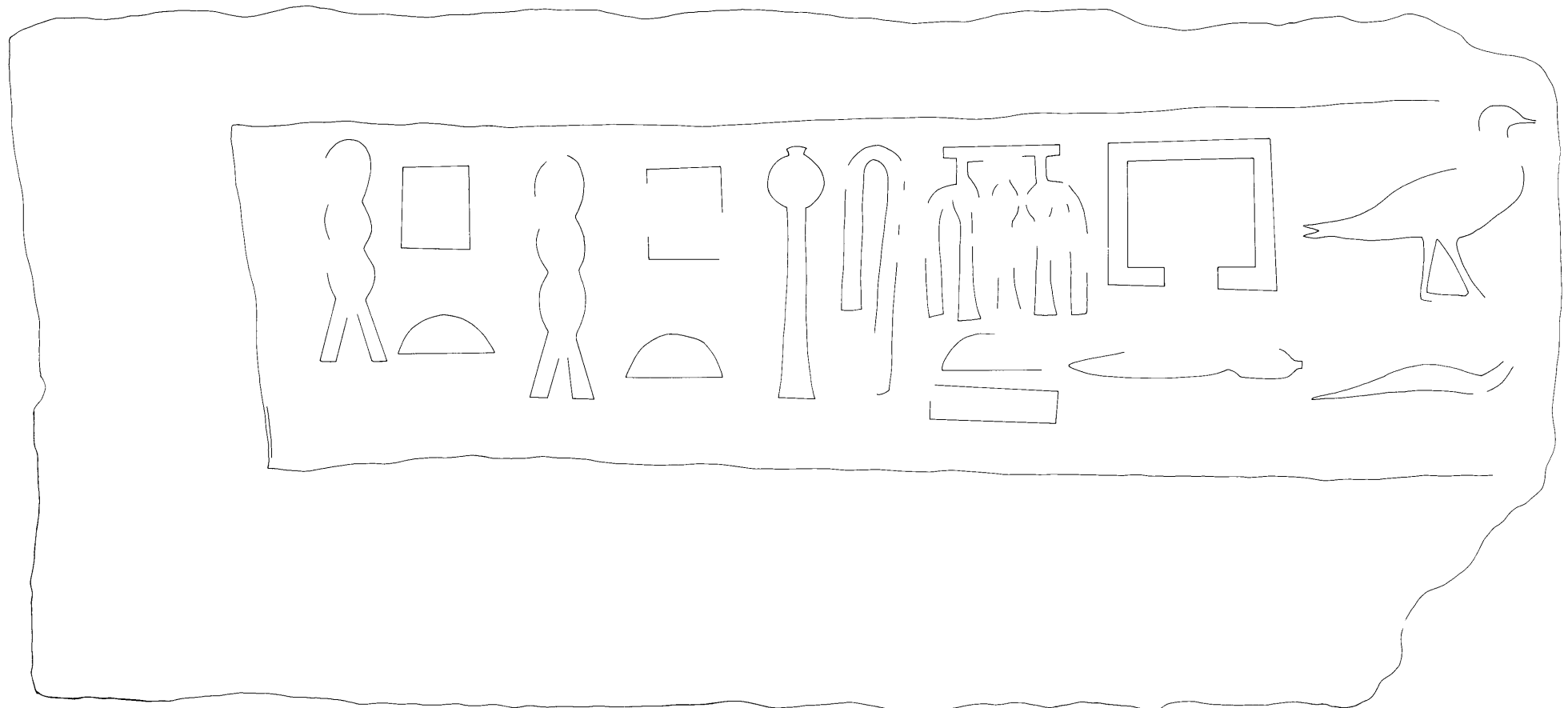

152a. 2088: Displaced lintel fragment. (See pl. 31b)

0 5 10  
cm (1:5)

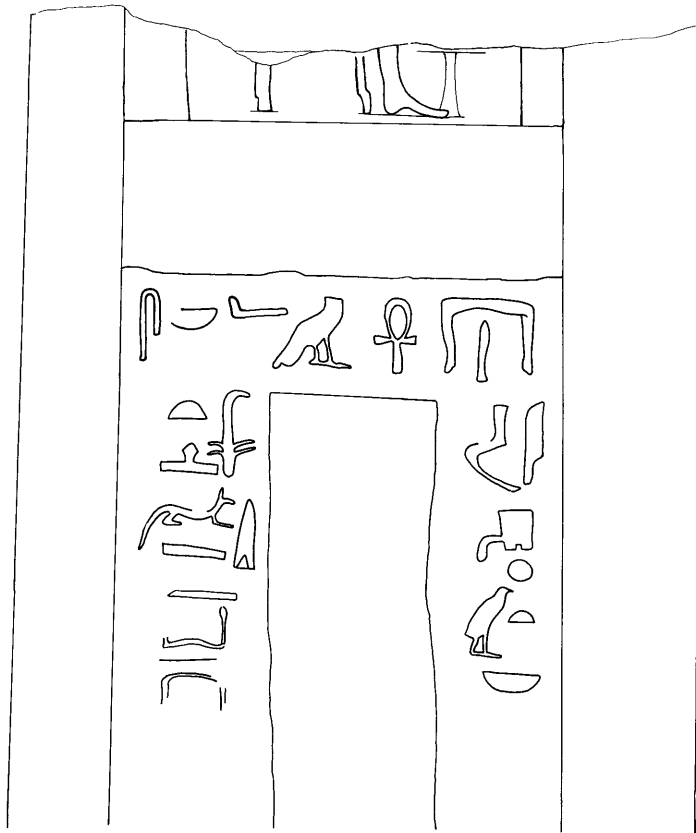

152b. 2088: Secondary false door set in embrasure north of chapel entrance. (See pl. 31c)

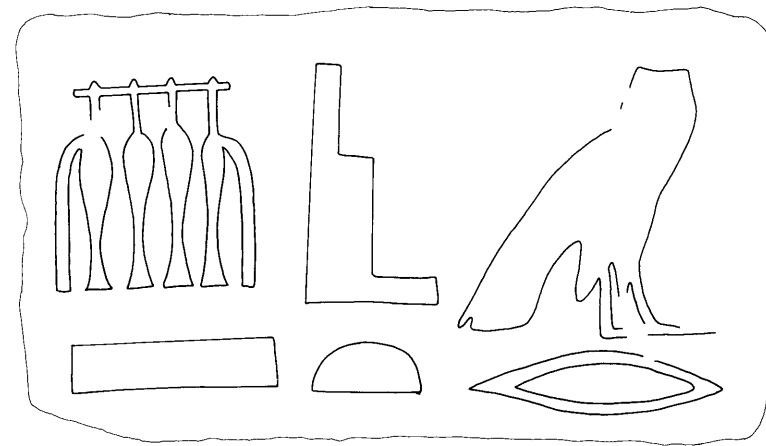

152c. 2088: Loose block from the top of shaft z

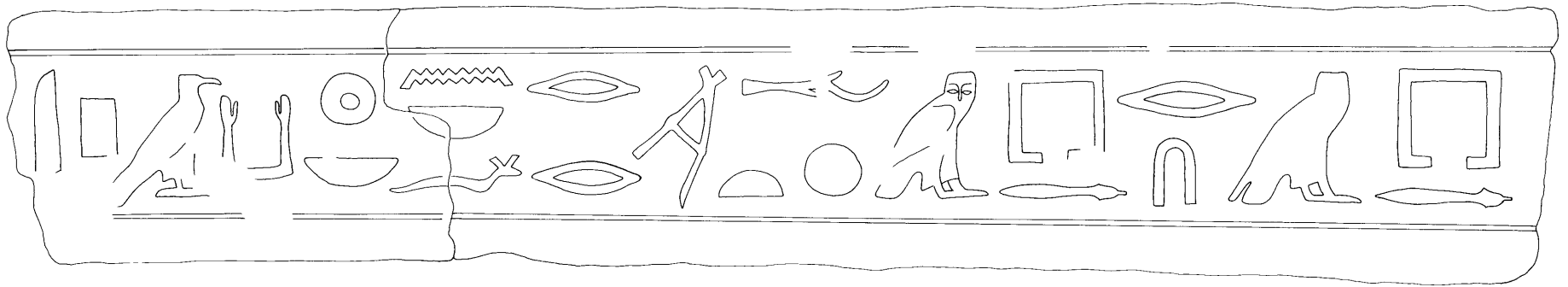

153a. 2091: Architrave or cornice. (See pl. 41a)

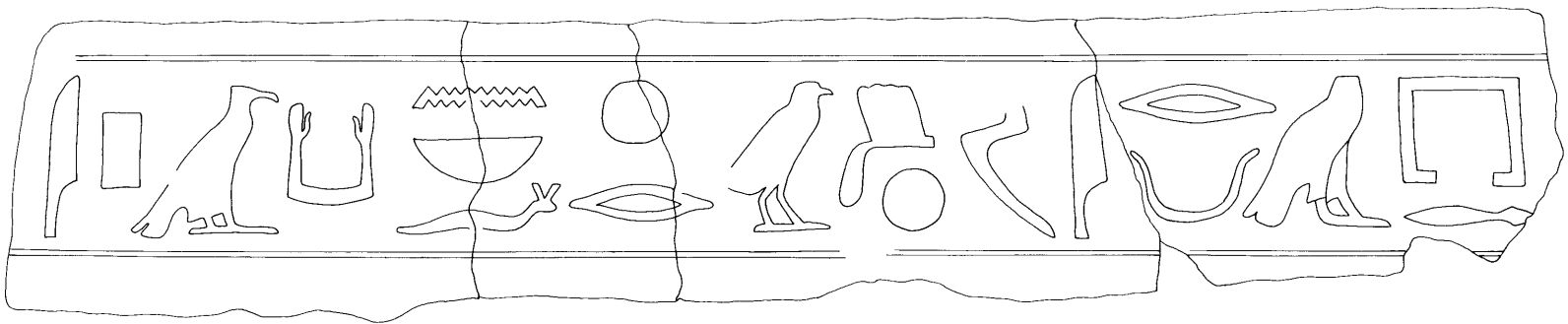
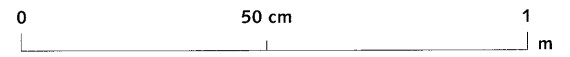

153b. 2091: Architrave or cornice. (See pl. 41b)

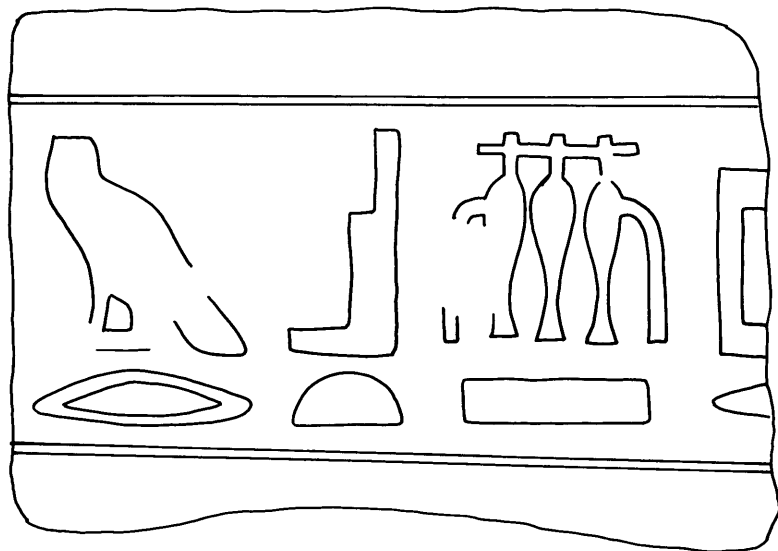
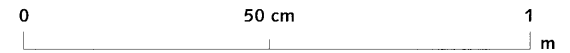

153c. 2091: Fragment of architrave or cornice

scale not determinable



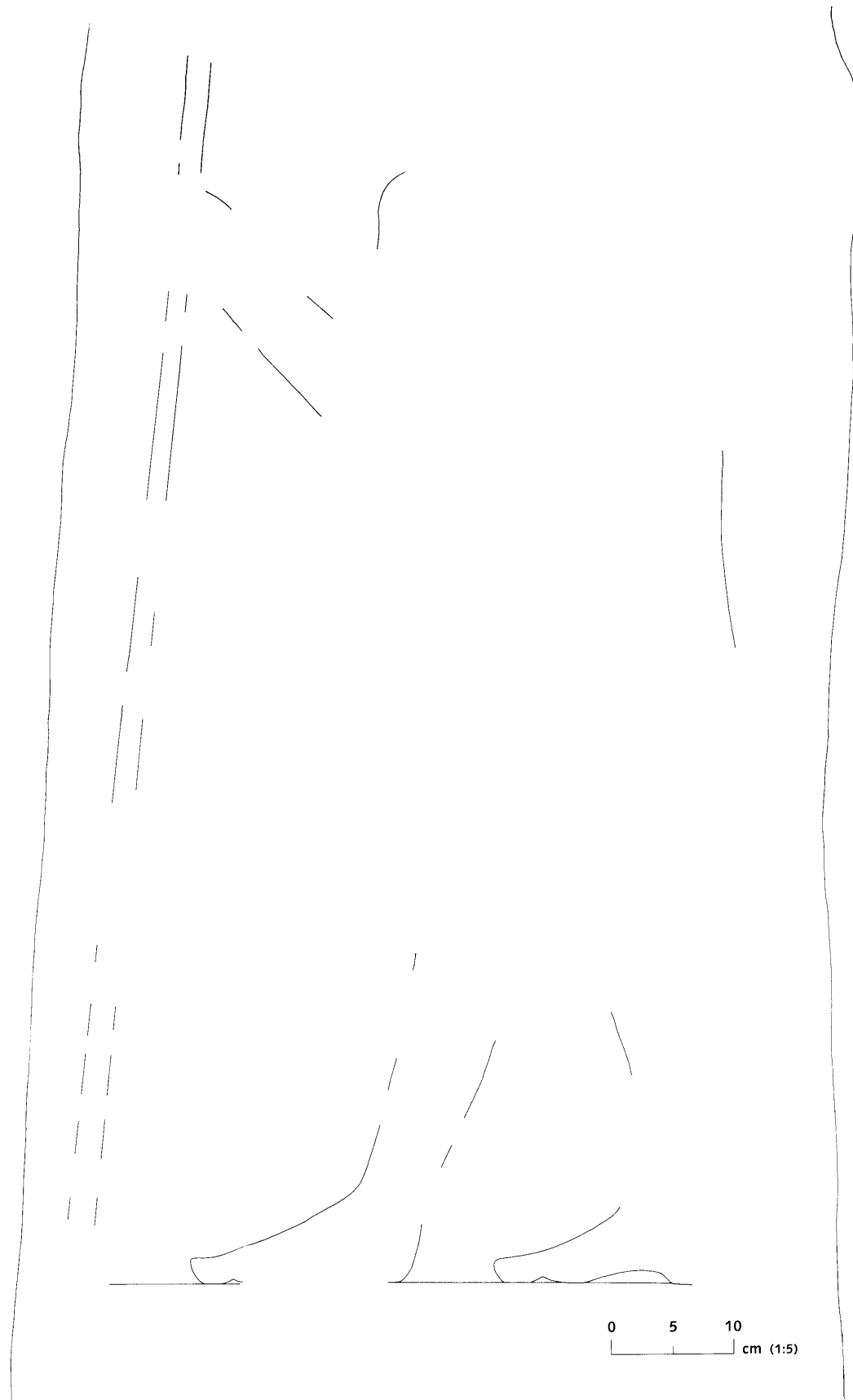
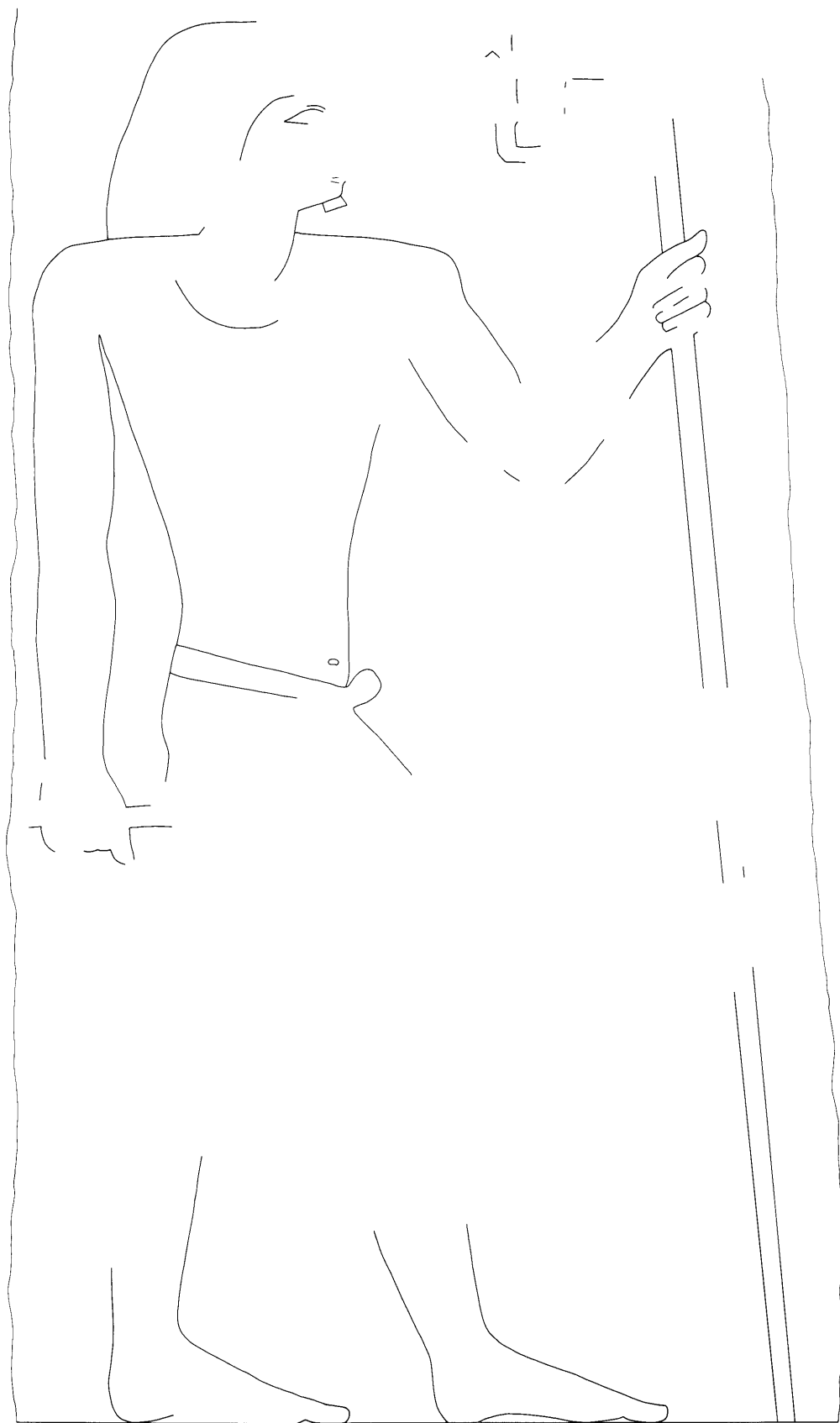

154a, b. 2091: Jams at northern entrance to corridor

0 5 10  
cm (1:5)

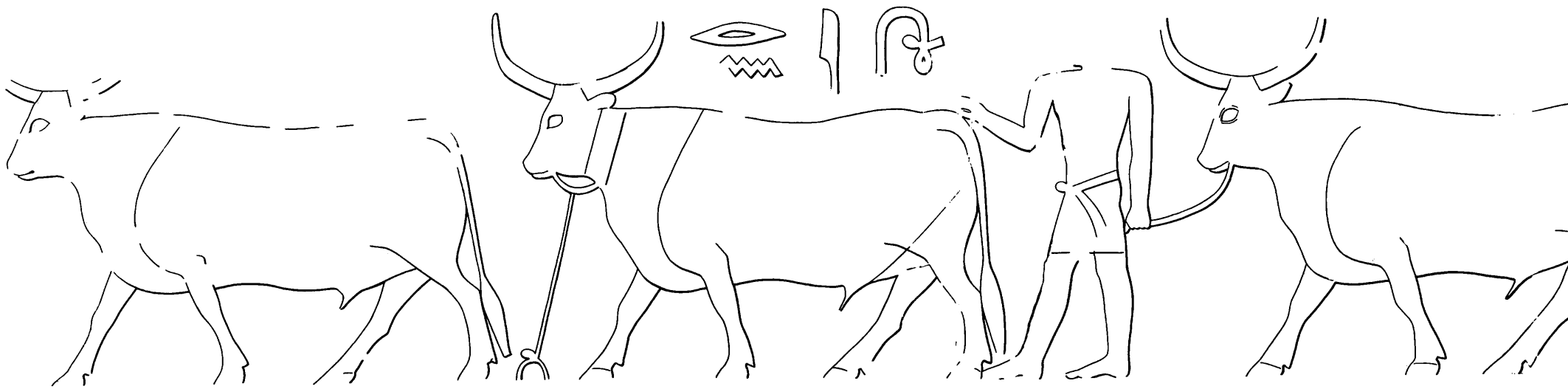
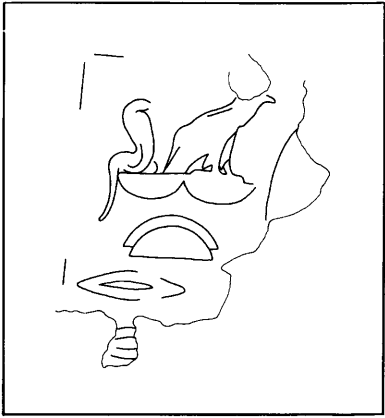

155. 2091: West wall of corridor, south end

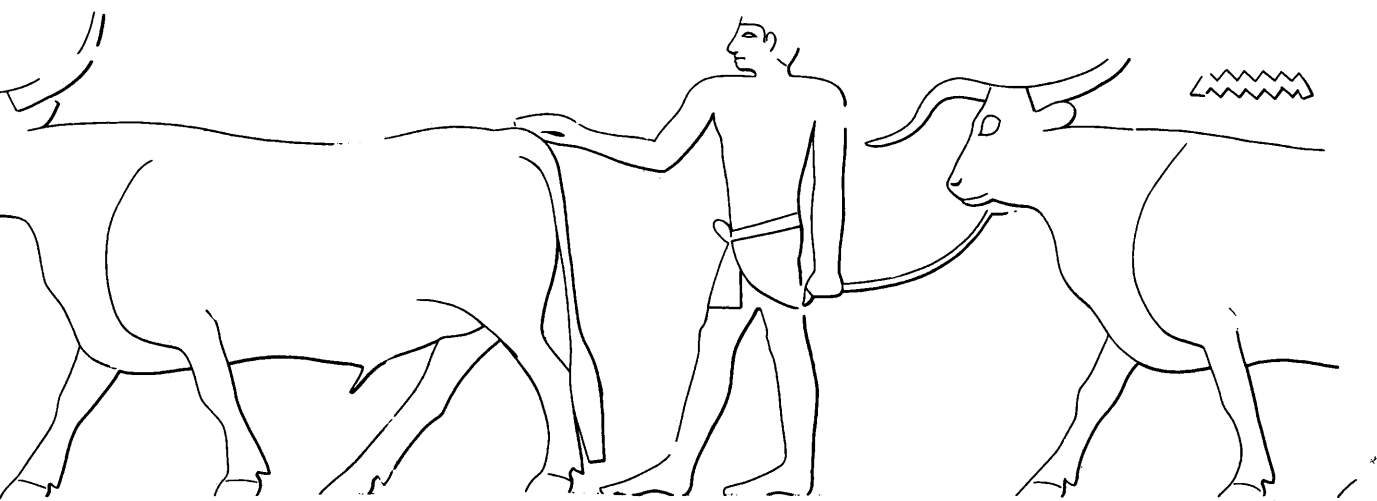

0 5 10  
cm (1:5)

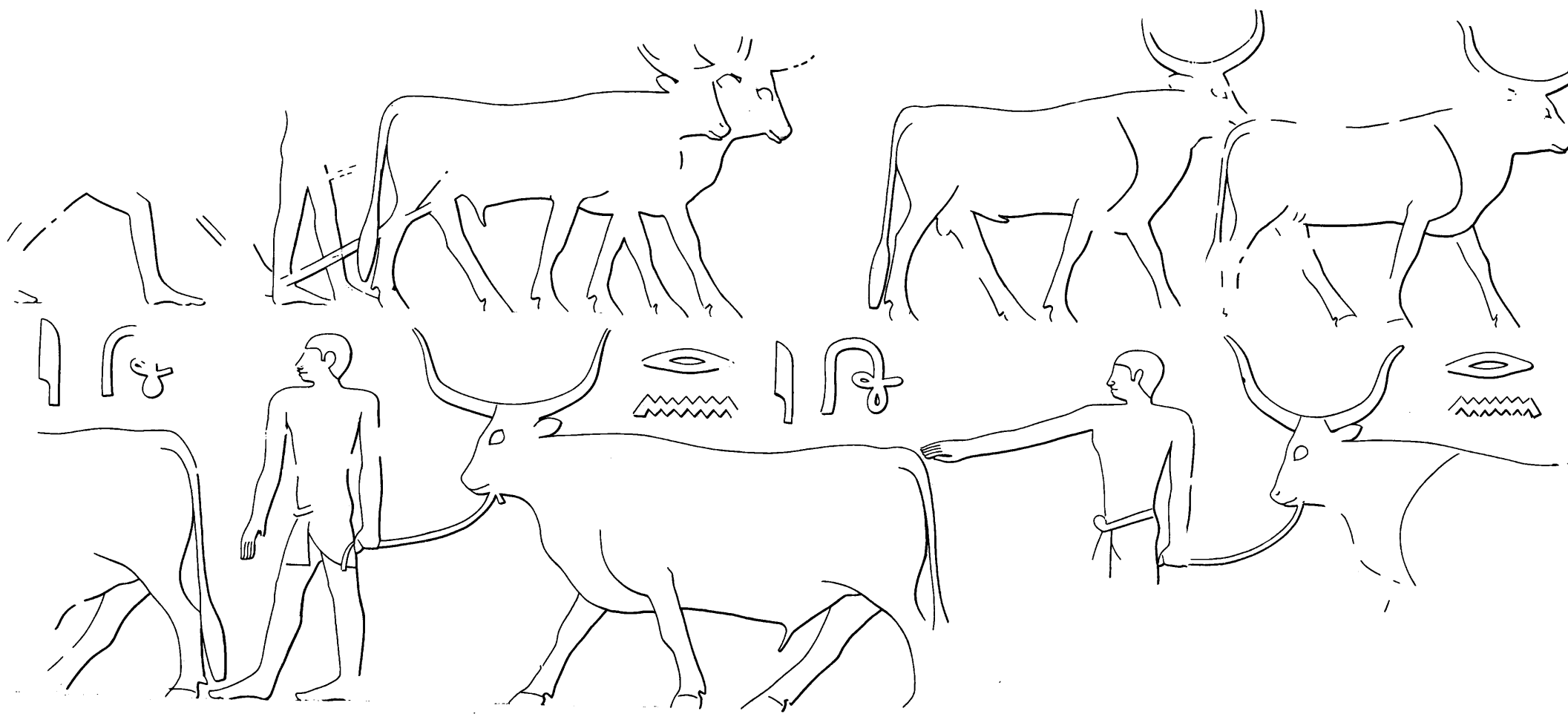

156. 2091: West wall of corridor, north end



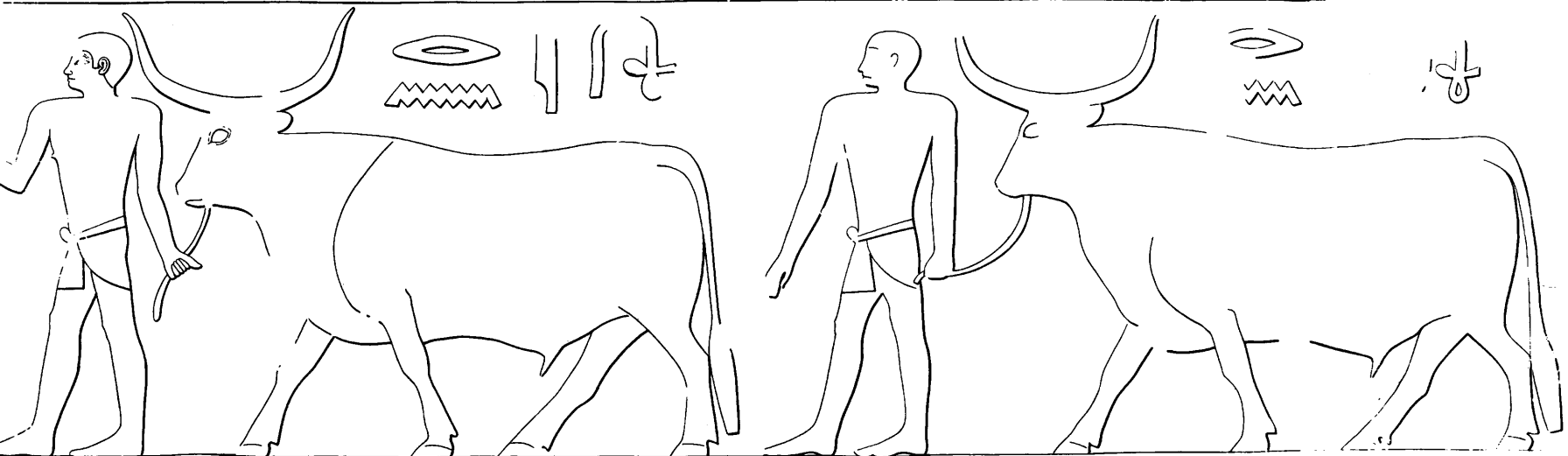
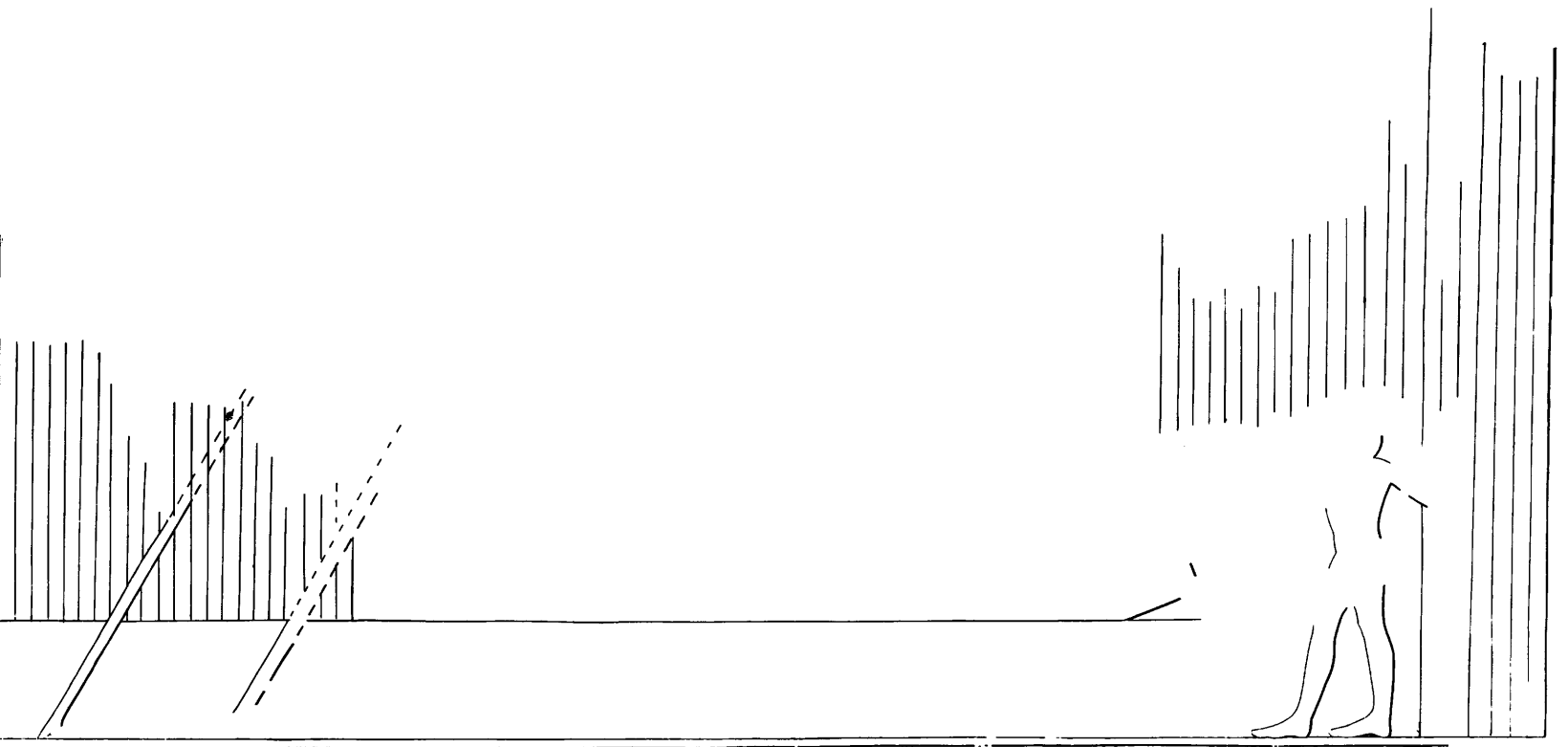

0 5 10  
cm (1:5)

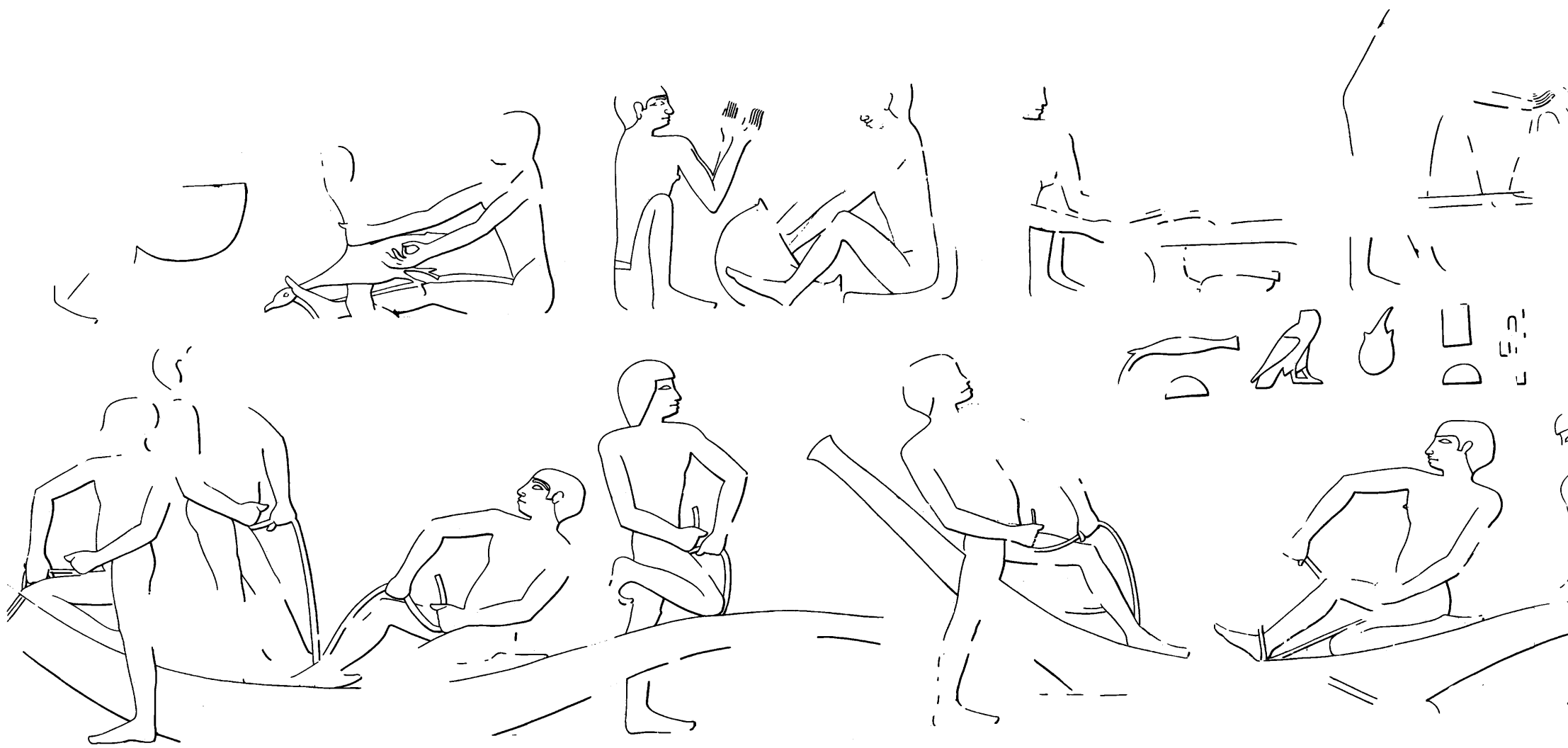

158. 2091: East wall of corridor, north end. (See pl. 42a)

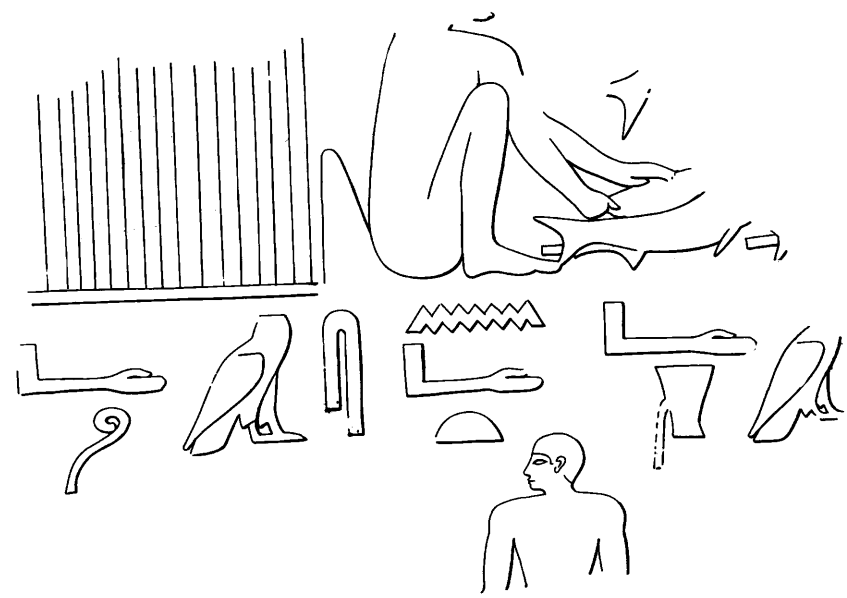

0 5 10  
cm (1:5)



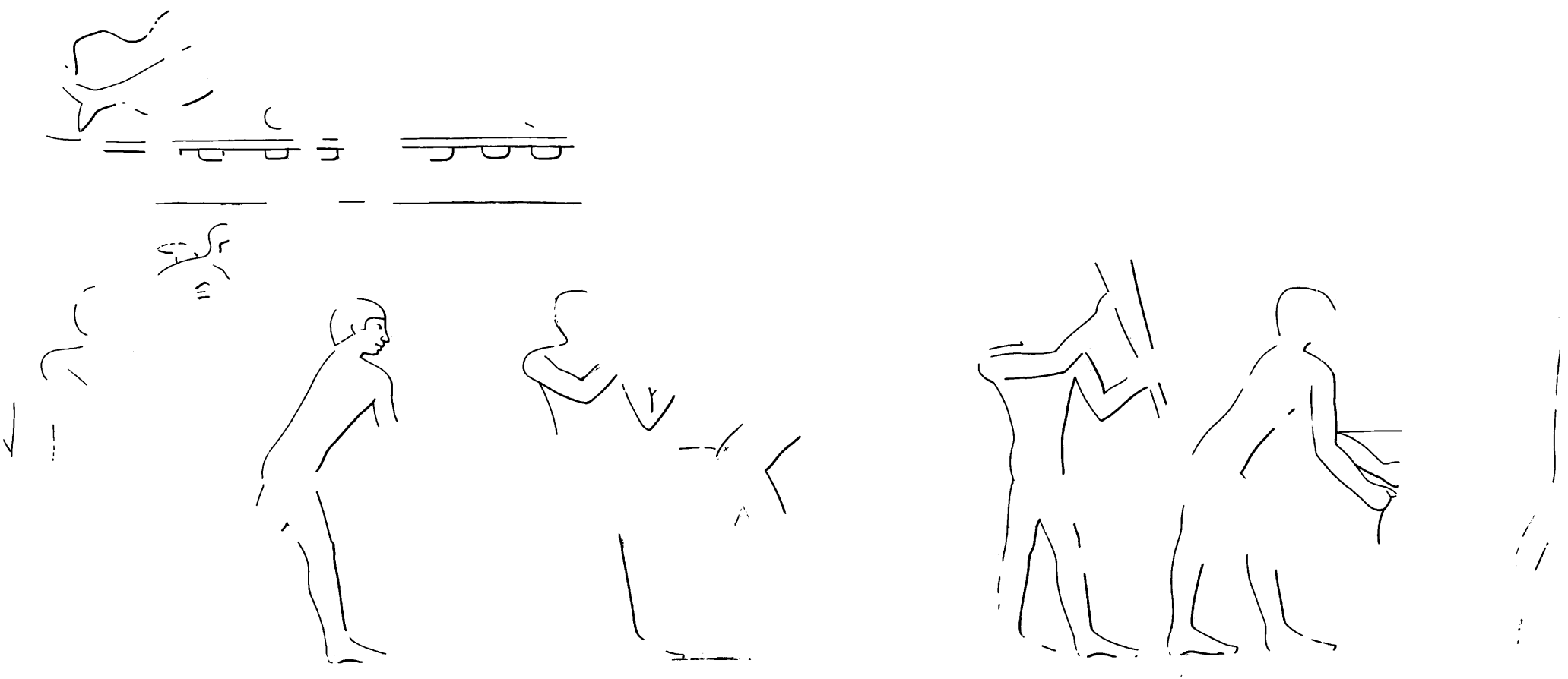

159. 2091: East wall of corridor, south end

1  
/ /  
:

/

/

|||  
==

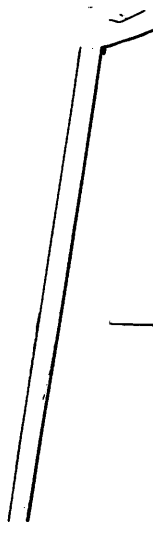
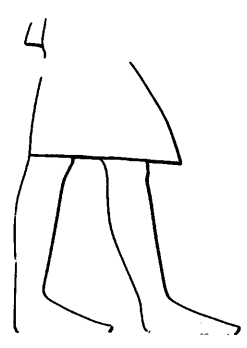



0 5 10  
cm (1:5)

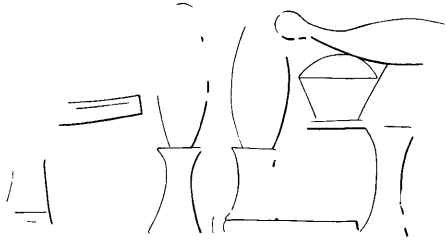

160a. 2091: Unplaced decoration from corridor

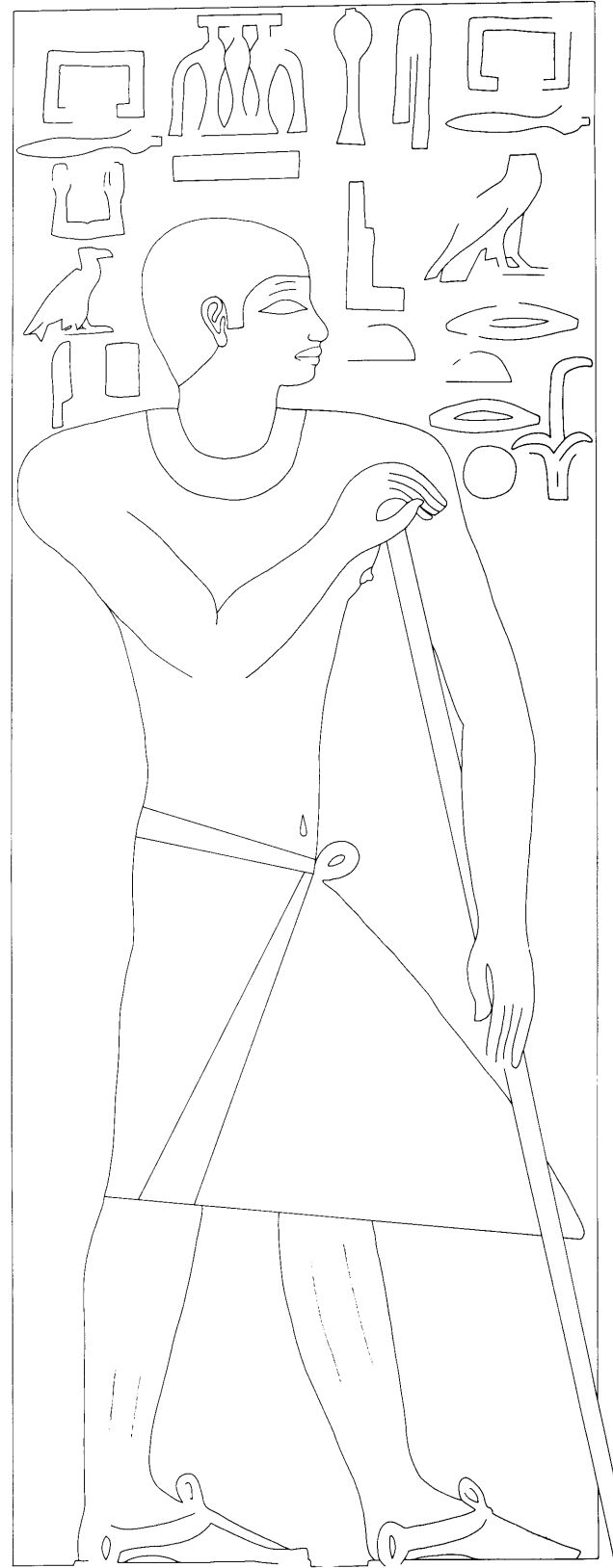

160b. 2091: East face of pillar. (See pls. 43b, 44, 45)

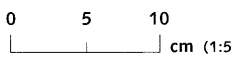

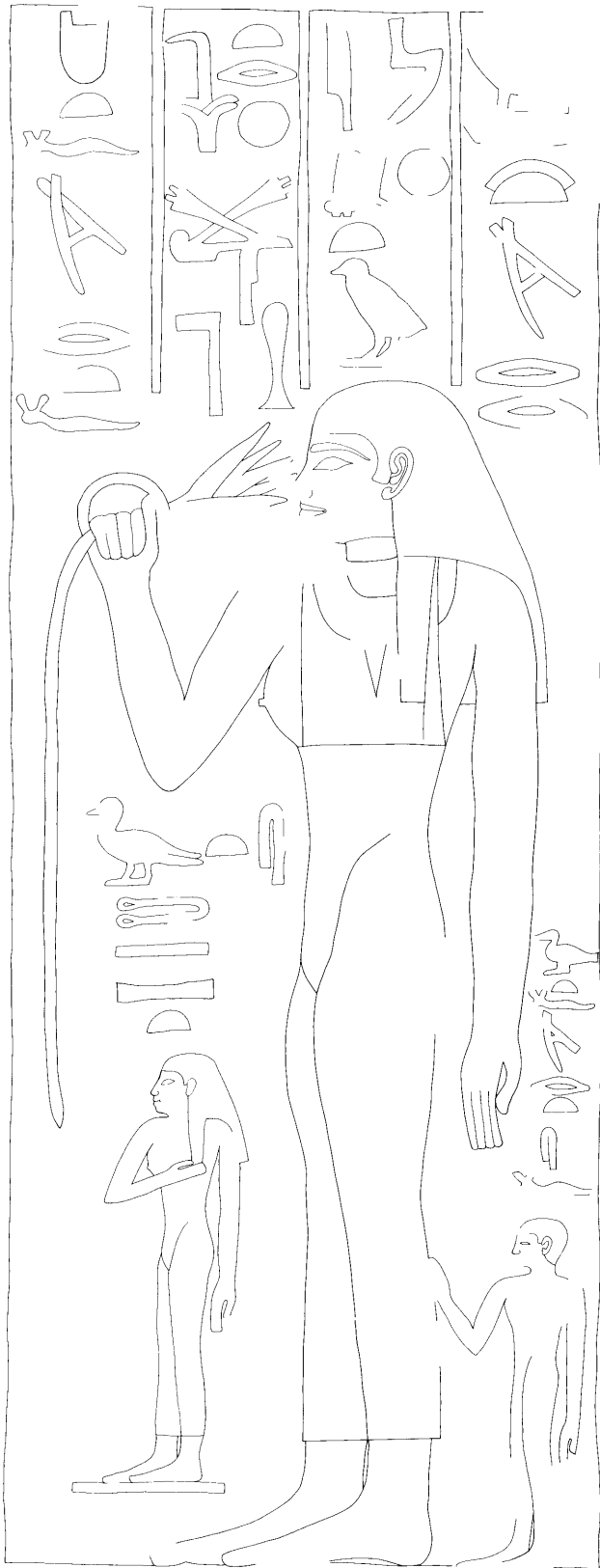

161a. 2091: North face of pillar. (See pls. 43b, 46, 47)

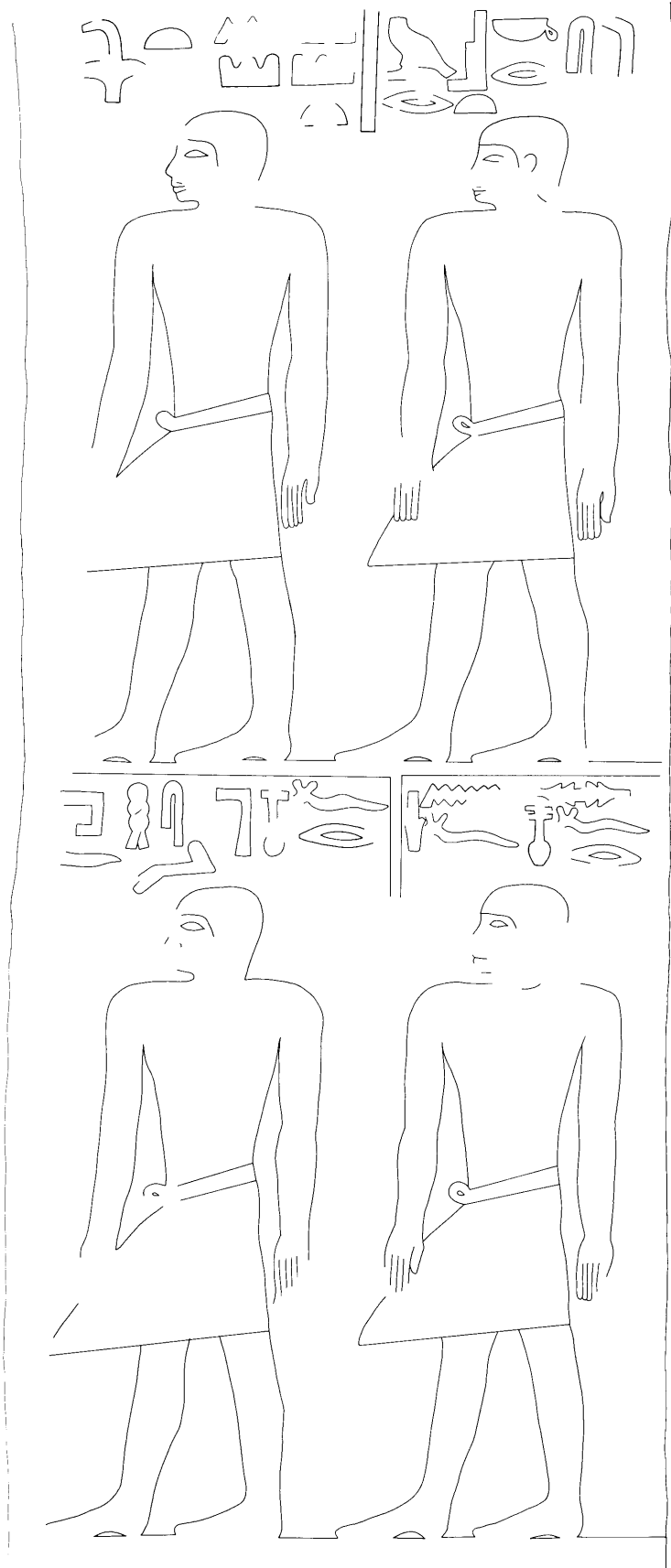

161b. 2091: South face of pillar. (See pl. 48)

0 5 10  
cm (1:5)

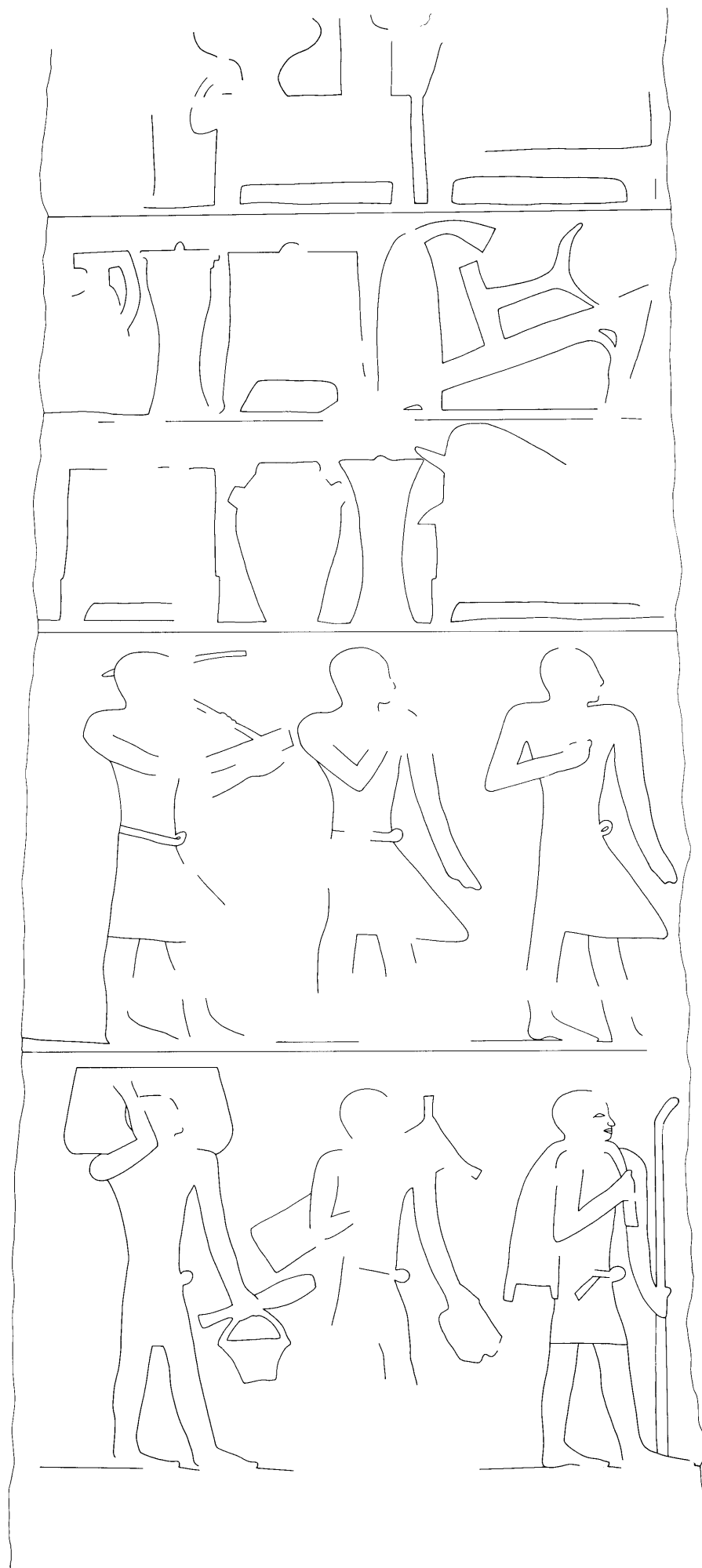

162. 2091: South pilaster of chapel. (See pl. 49)

0 5 10  
cm (1:5)



163. 2091: South wall of chapel. (See pls. 50, 51, 52)

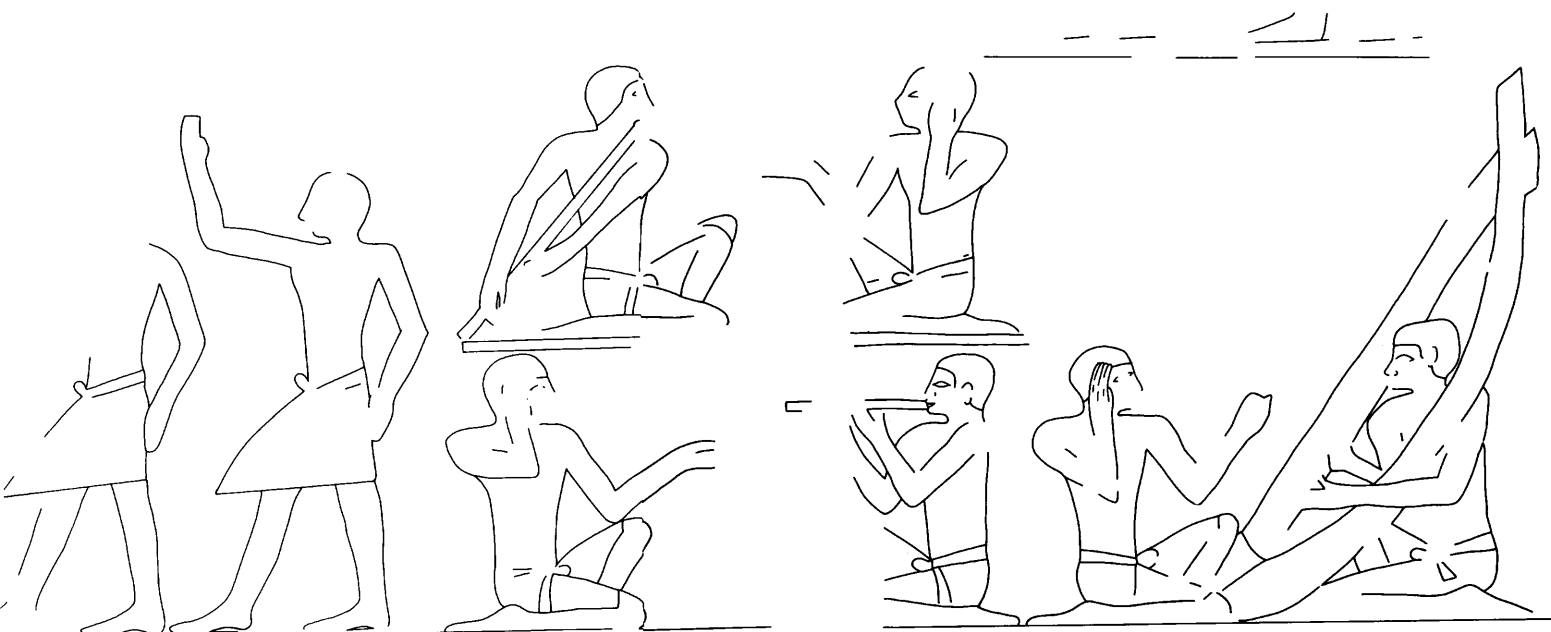
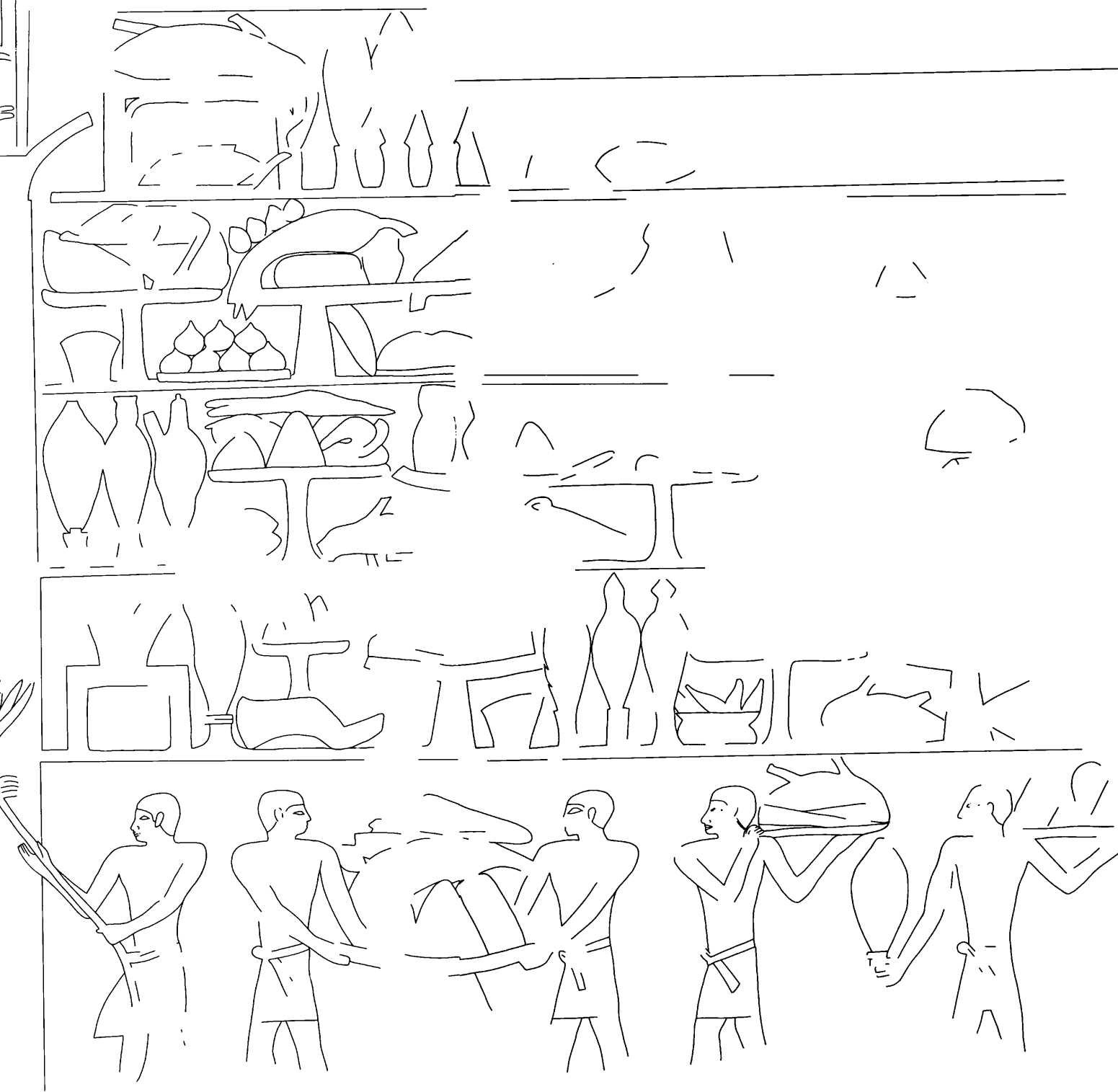

0 5 10  
cm (1:5)



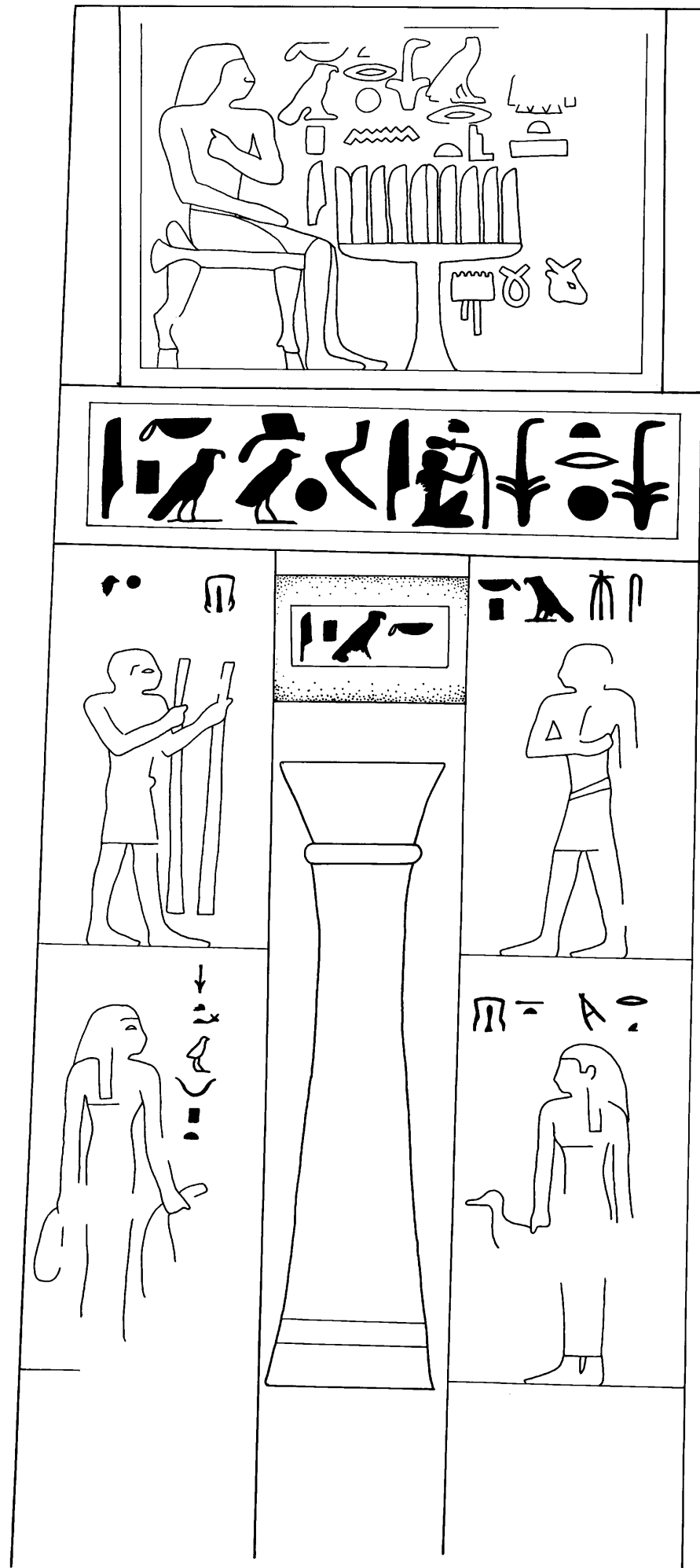

164. 2091: False doors of chapel. (See pls. 53, 54)

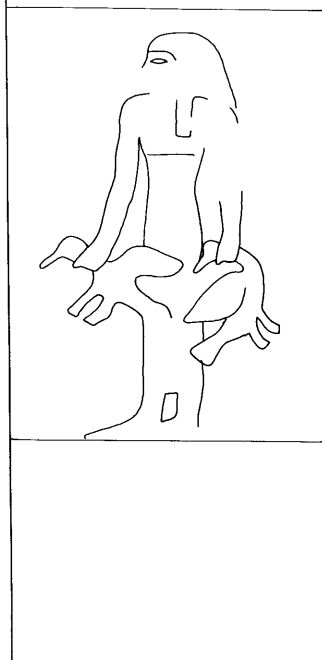
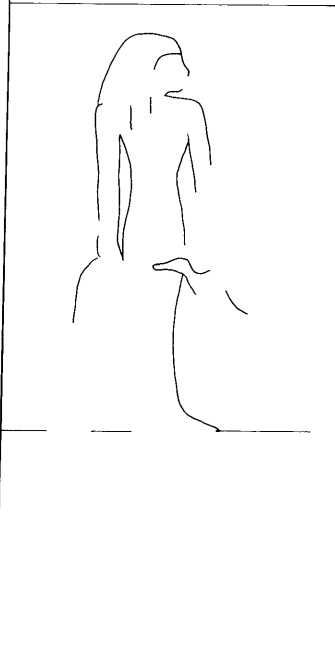
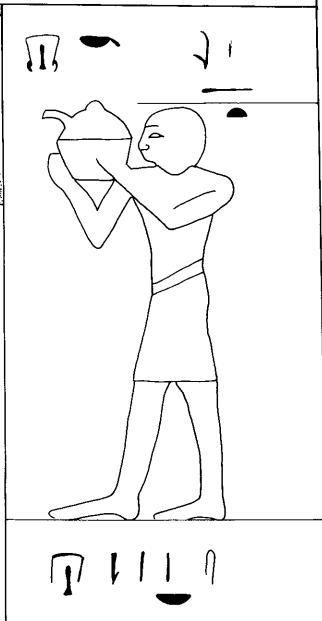
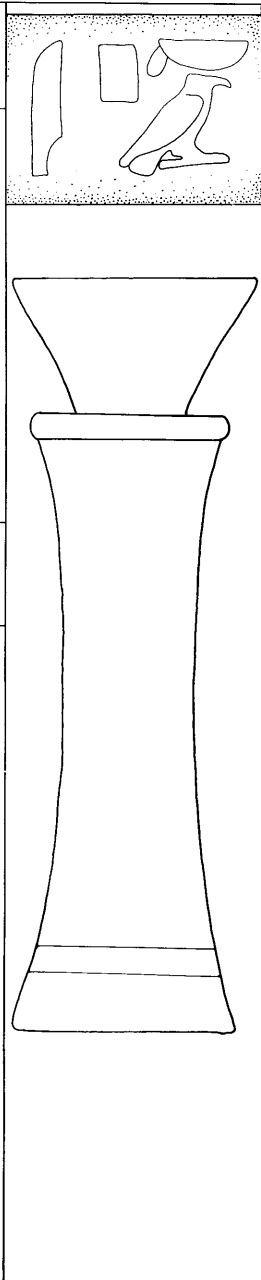
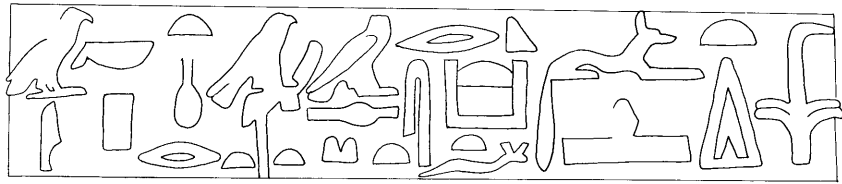
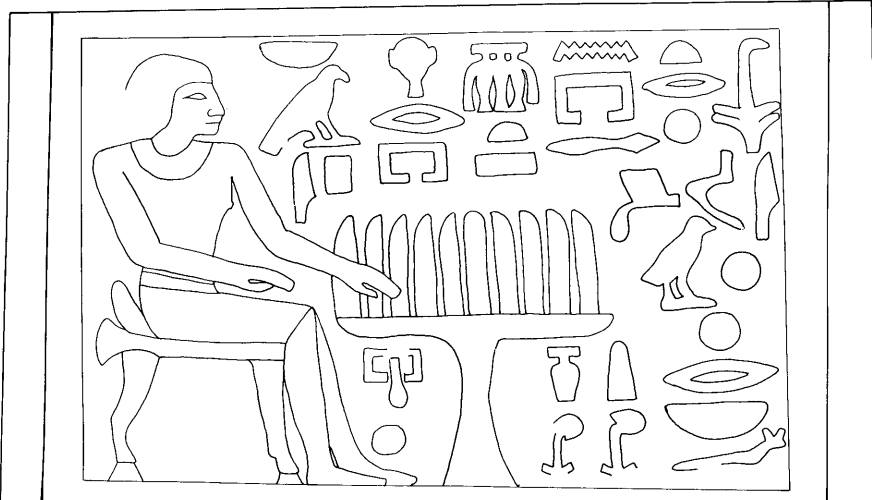

0 10 20 cm



165. 2091: Lintel over false doors on west wall of chapel. (See pl. 55)

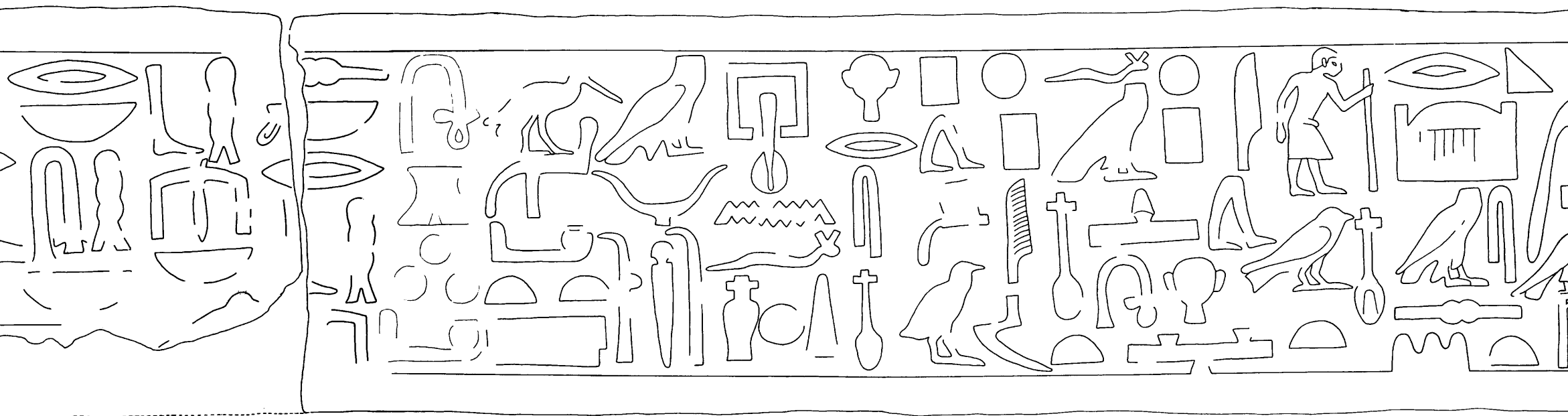

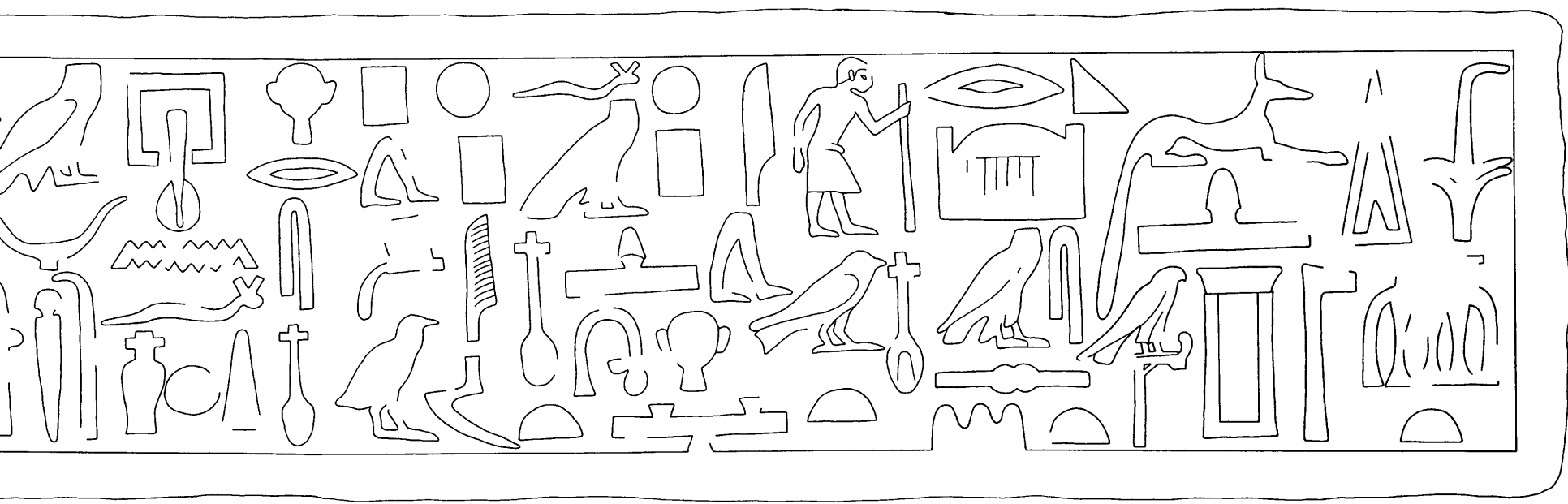

0 5 10  
cm (1:5)



← GAP →

166. 2091: Decoration on both ends of west wall above lintel. (See pls. 55a, 55c)



← GAP →

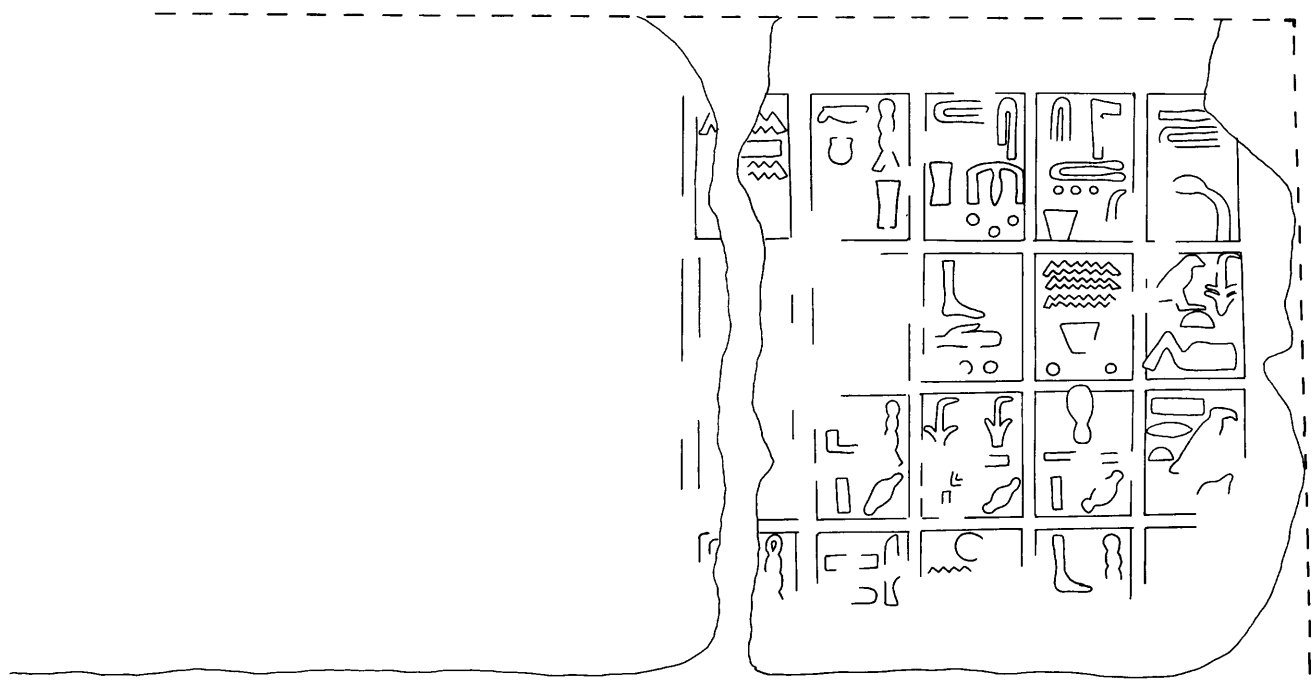

0 10 20 cm

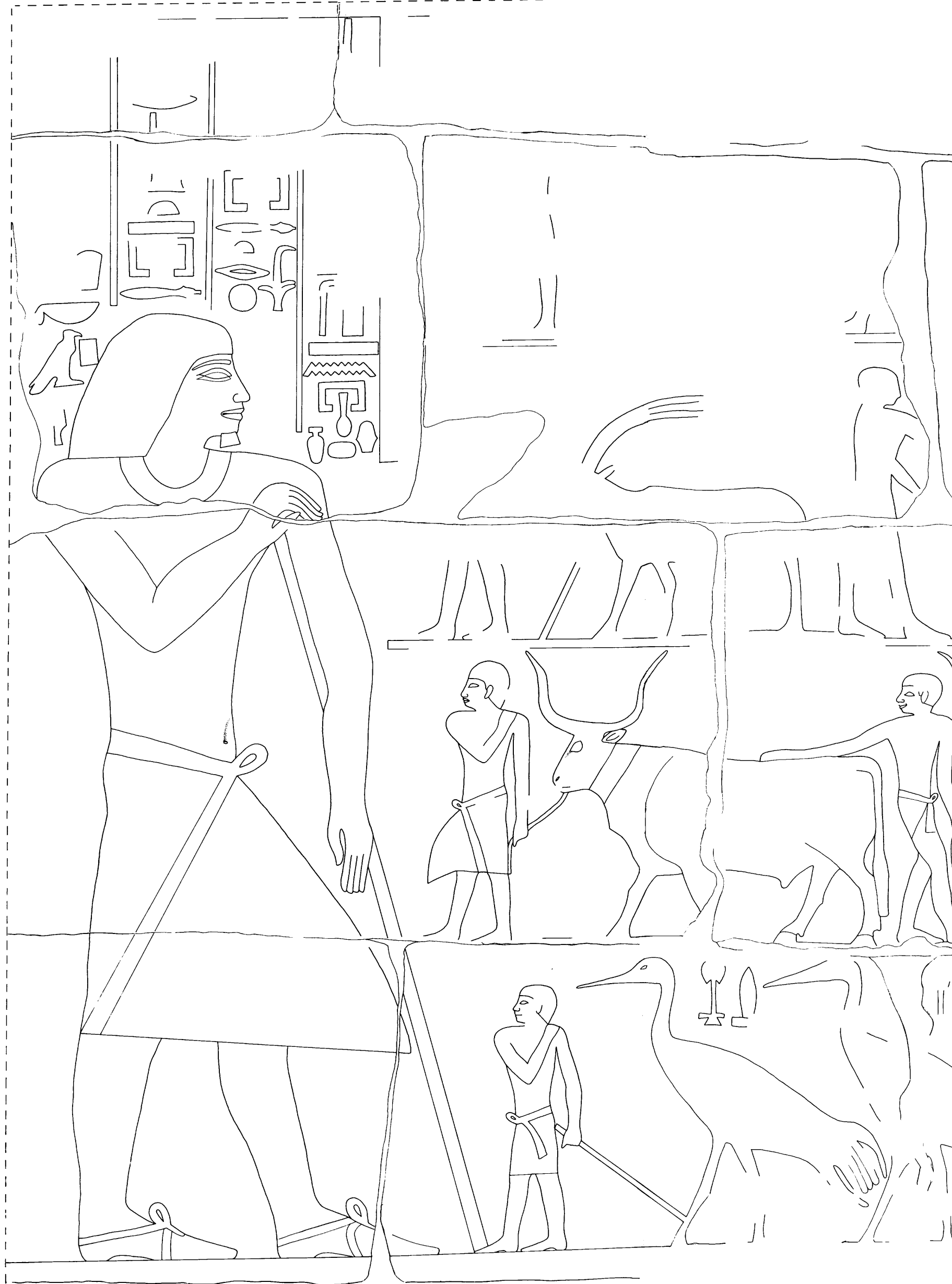

167. 2091: North wall of chapel.  
(See pls. 56, 57, 58)





0 5 10  
cm (1:5)

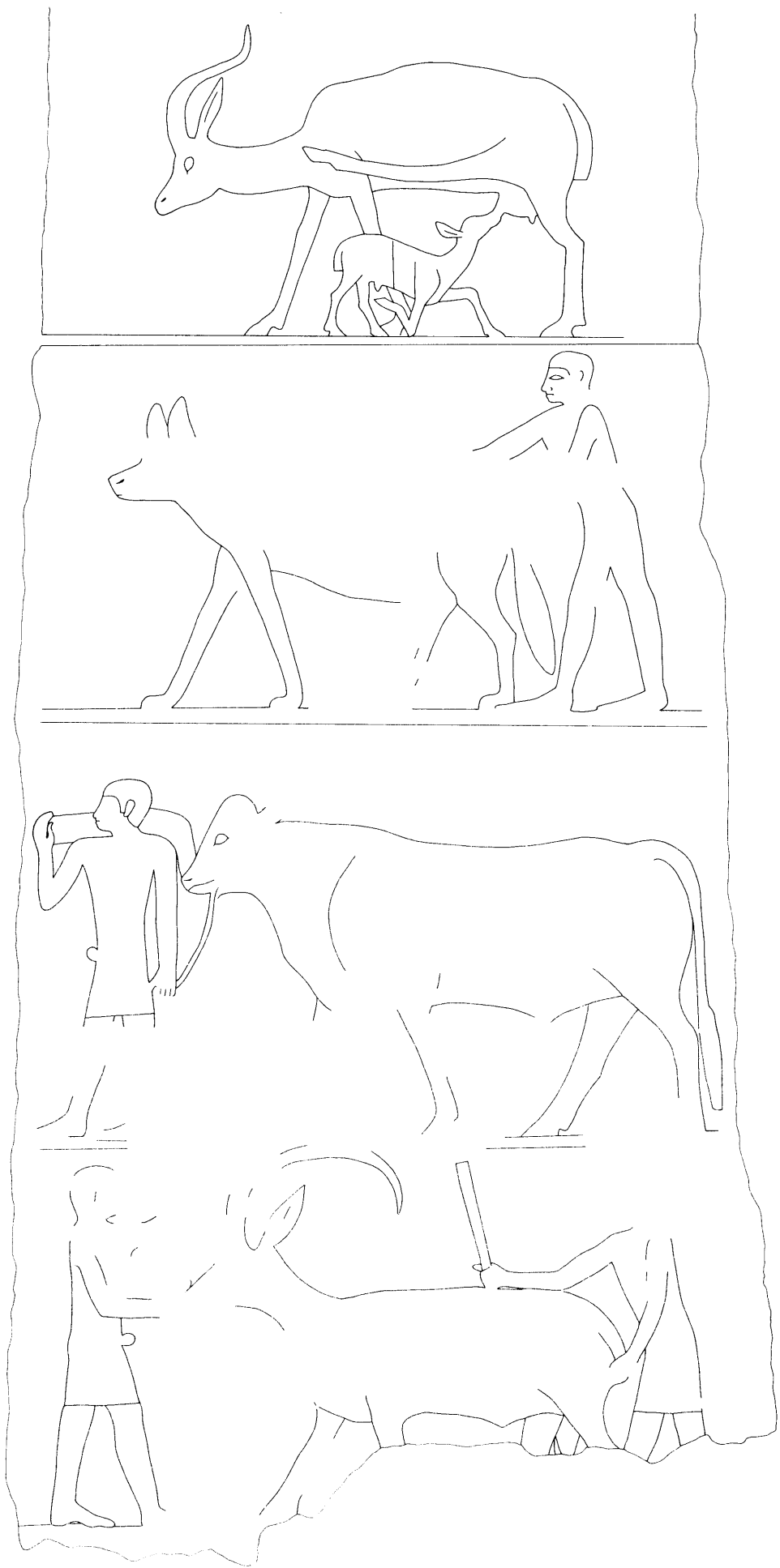

168. 2091: North pilaster of chapel. (See pls. 59, 60a)

0 5 10  
|-----| cm (1:5)

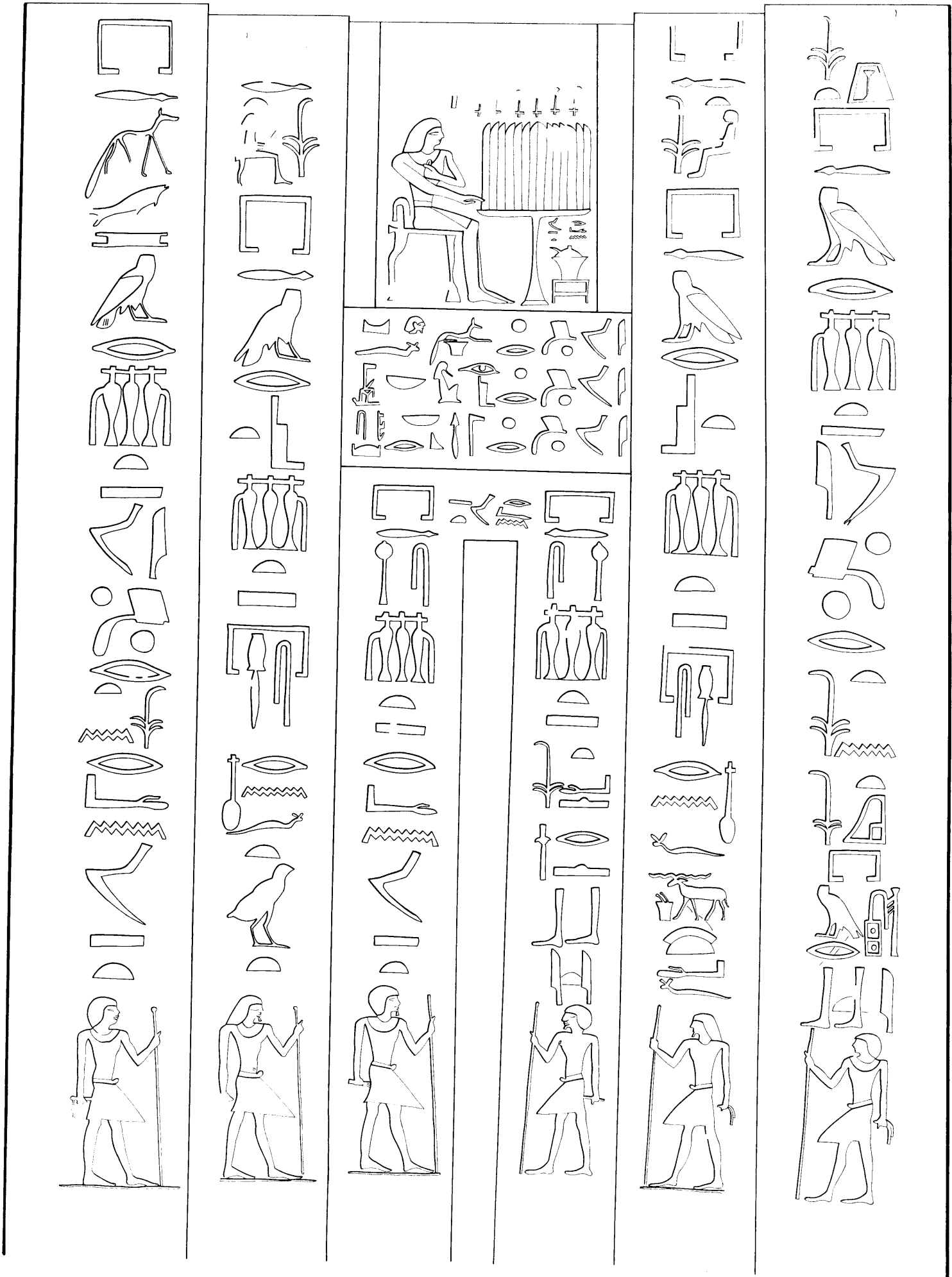

169. 2092a: False door. (See pl. 64)

0 5 10  
cm (1:5)

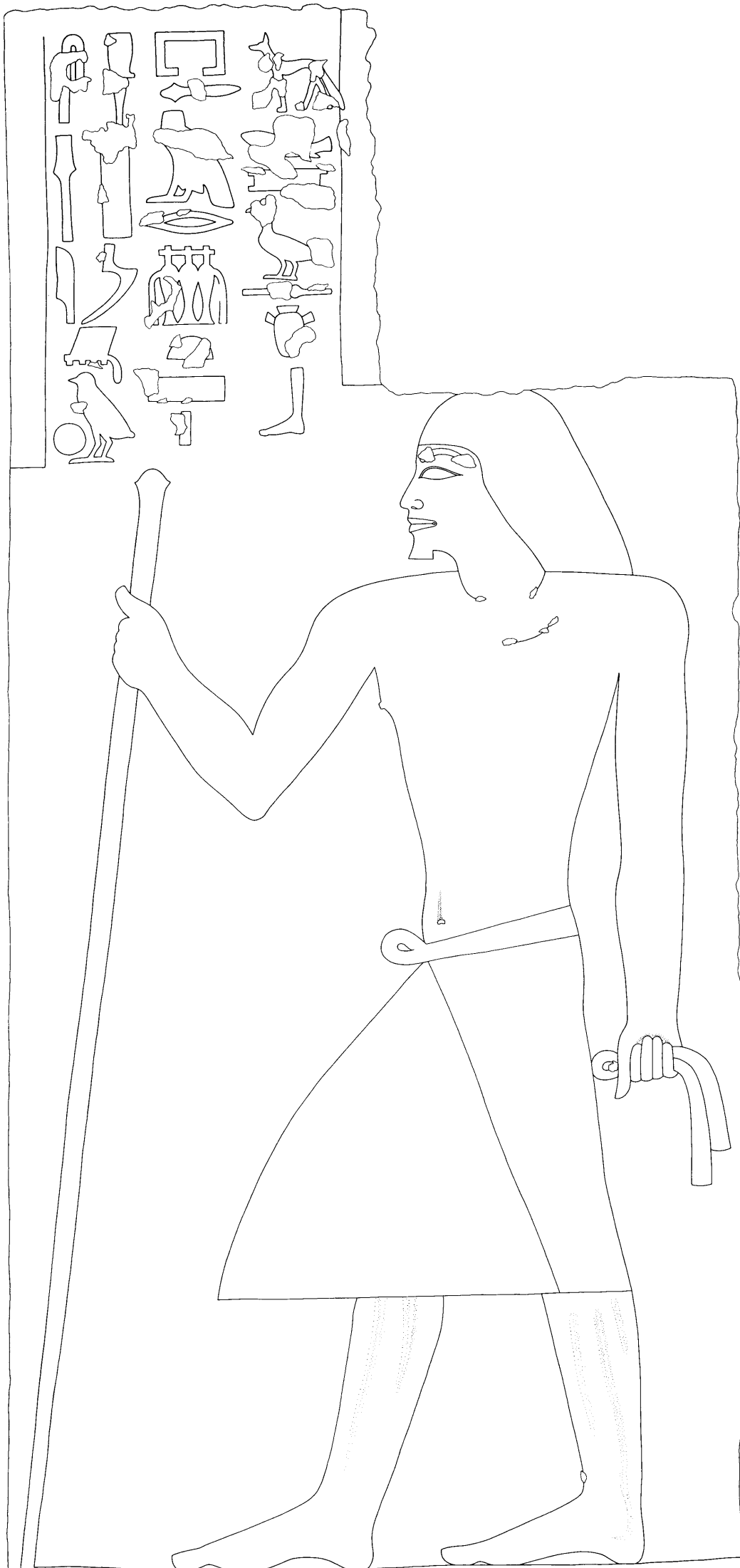

170. 2092+2093: East entrance doorjamb. (See pl. 67a)

0 5 10  
cm (1:5)



171. 2092+2093: West entrance doorjamb. (See pl. 67b)

0 5 10  
cm (1:5)

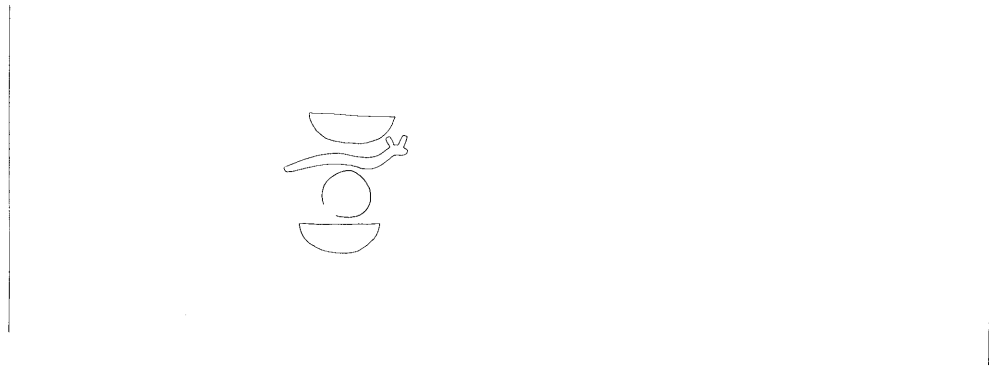

172a. 2092+2093: Unfinished inscription on entrance drum lintel. (See pl. 67)

0 5 10  
cm (1:5)

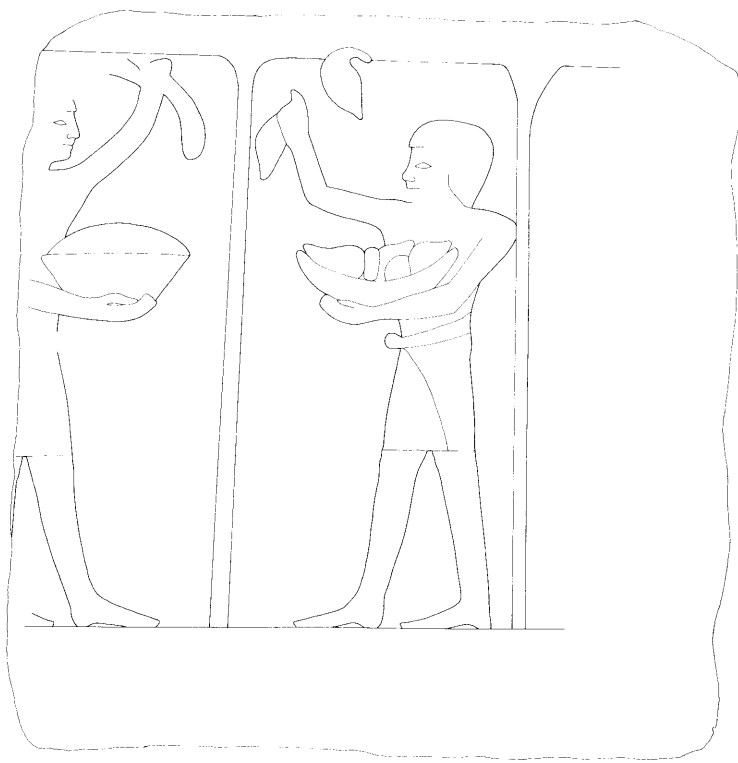

172b. 2092+2093: North end of west wall of corridor into chapel. (See pl. 68a)

0 5 10  
cm (1:5)



172c. 2092+2093: Loose block. (See pl. 68b)

scale not determinable

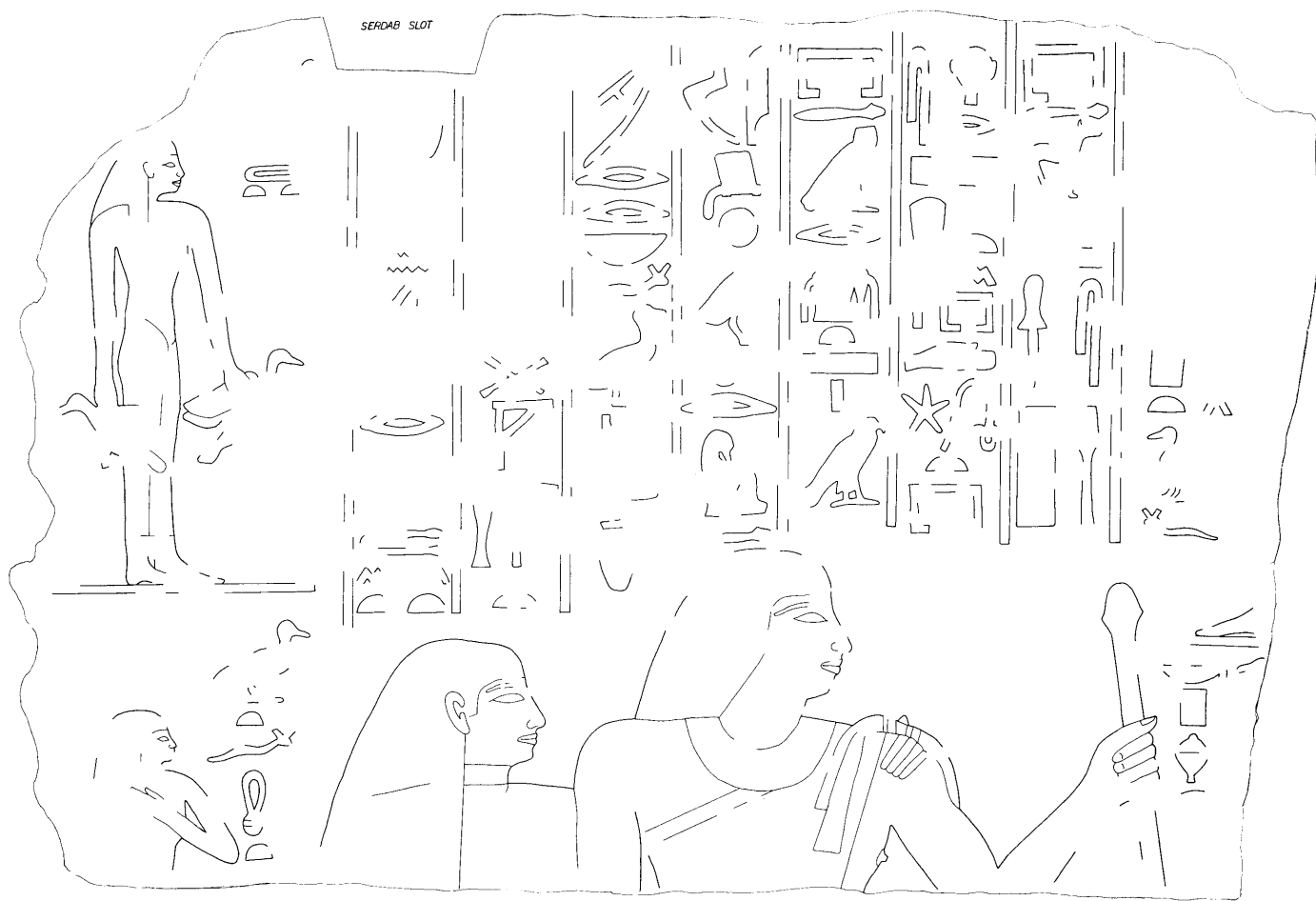

173a. 2092+2093: Loose block from top of 2096. (See pl. 68c)

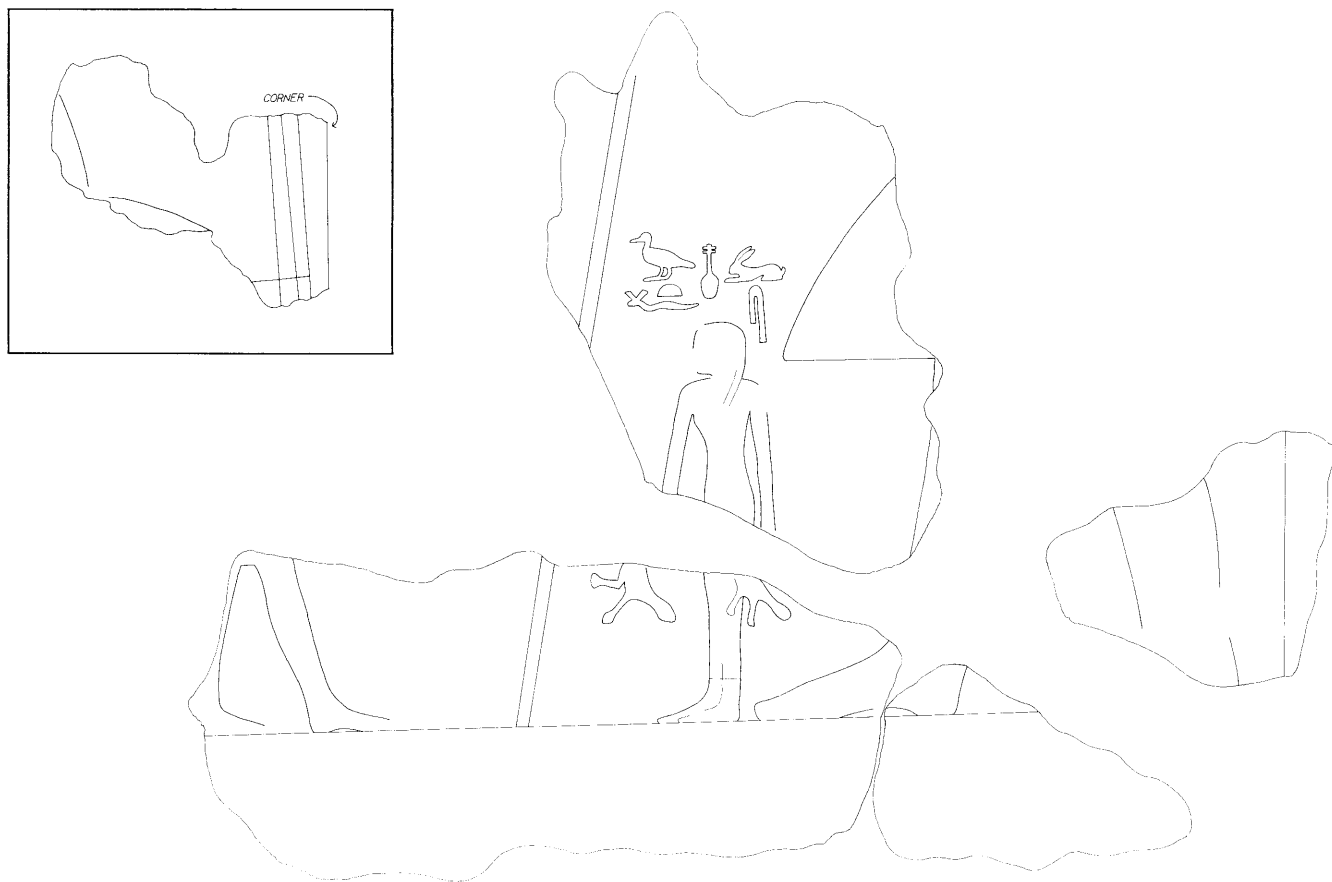

173b, c. 2092+2093: Loose blocks. All blocks seem to belong to the same scene. (See pl. 68d)

0 5 10  
cm (1:5)

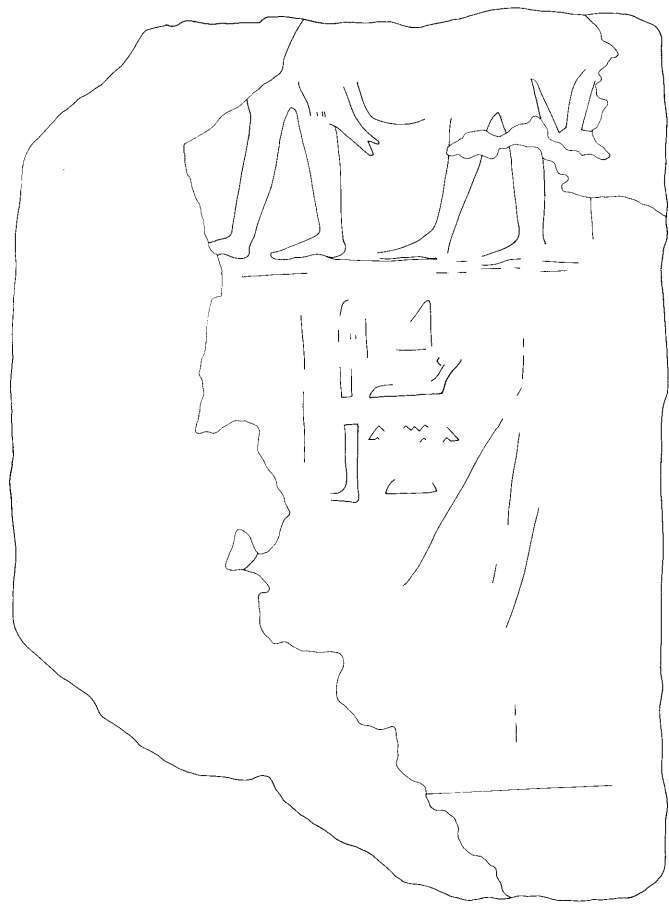

174. 2092+2093: Loose block, probably from here. (See pl. 68d)

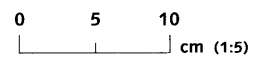





175a. 2092+2093: Dislocated pillar, perhaps south face. (See pl. 69a)

0 5 10  
cm (1:5)

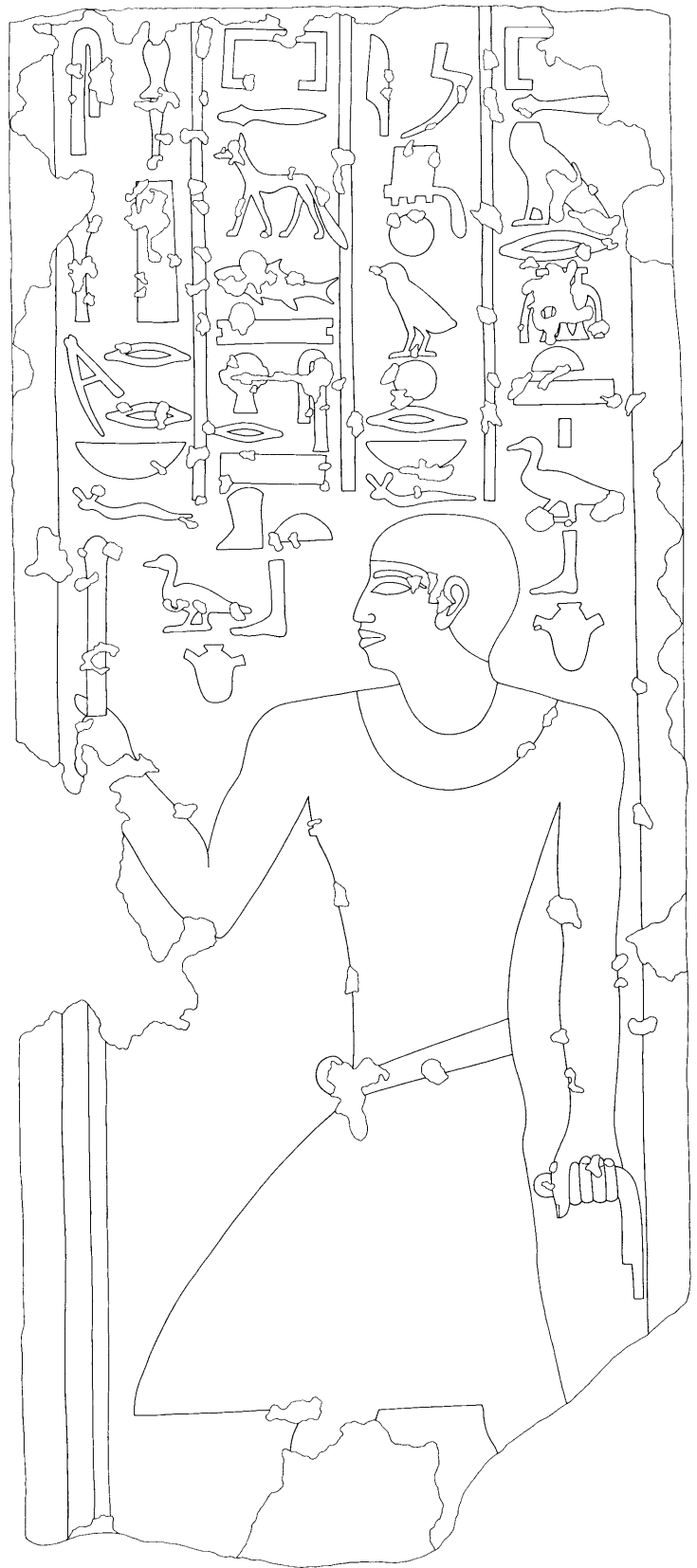

175b. 2092+2093: Dislocated pillar, perhaps east face. (See pl. 69b)

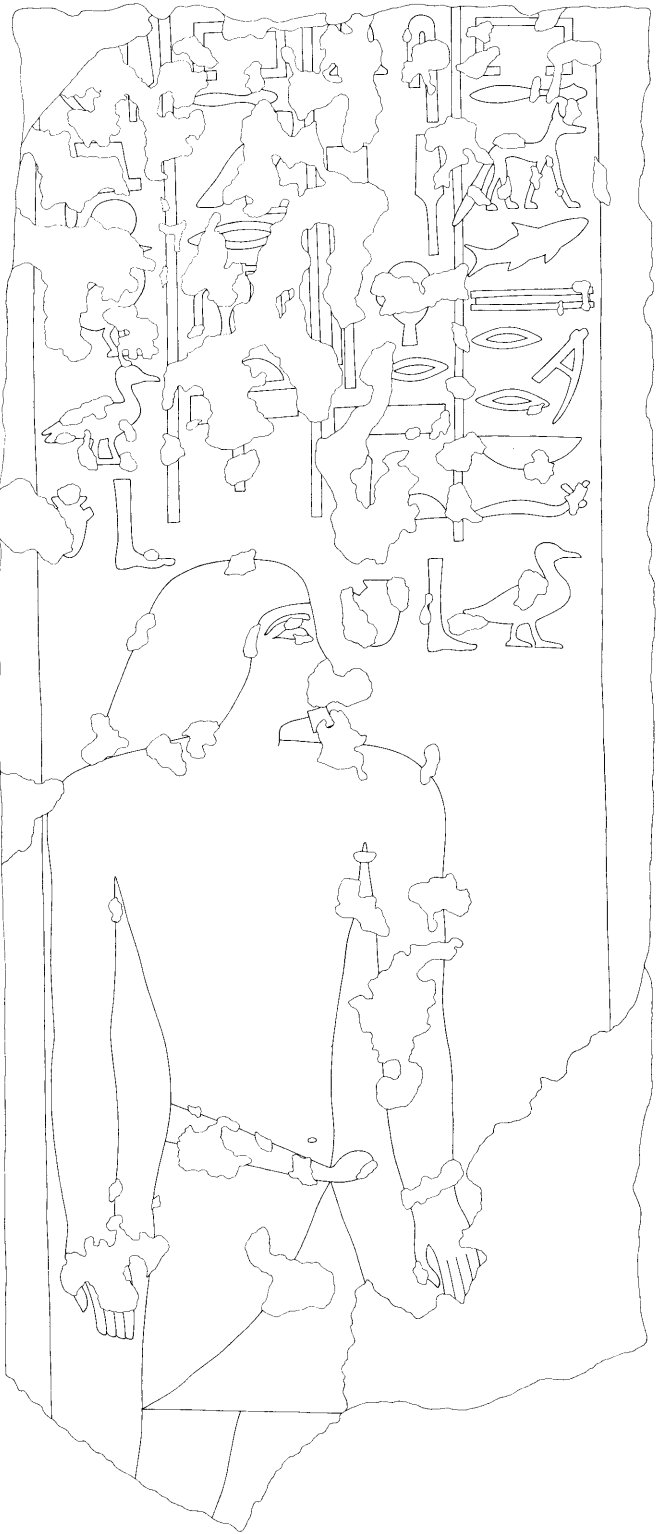

176a. 2092+2093: Dislocated pillar, perhaps north face. (See pl. 69c)



176b. 2092+2093: Dislocated pillar, perhaps west face. (See pl. 69d)

0 5 10  
cm (1:5)

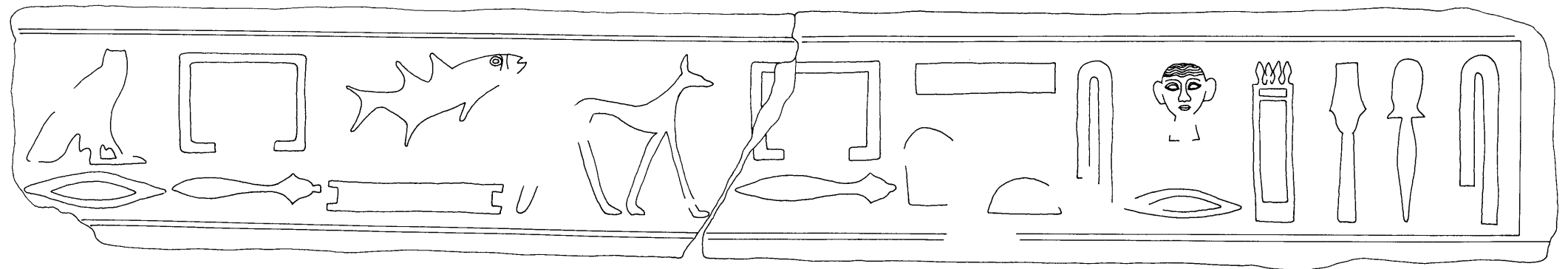

177. 2092+2093: Architrave fragment from path south of mastaba. (See pl. 70a)

0 5 10  
cm (1:5)

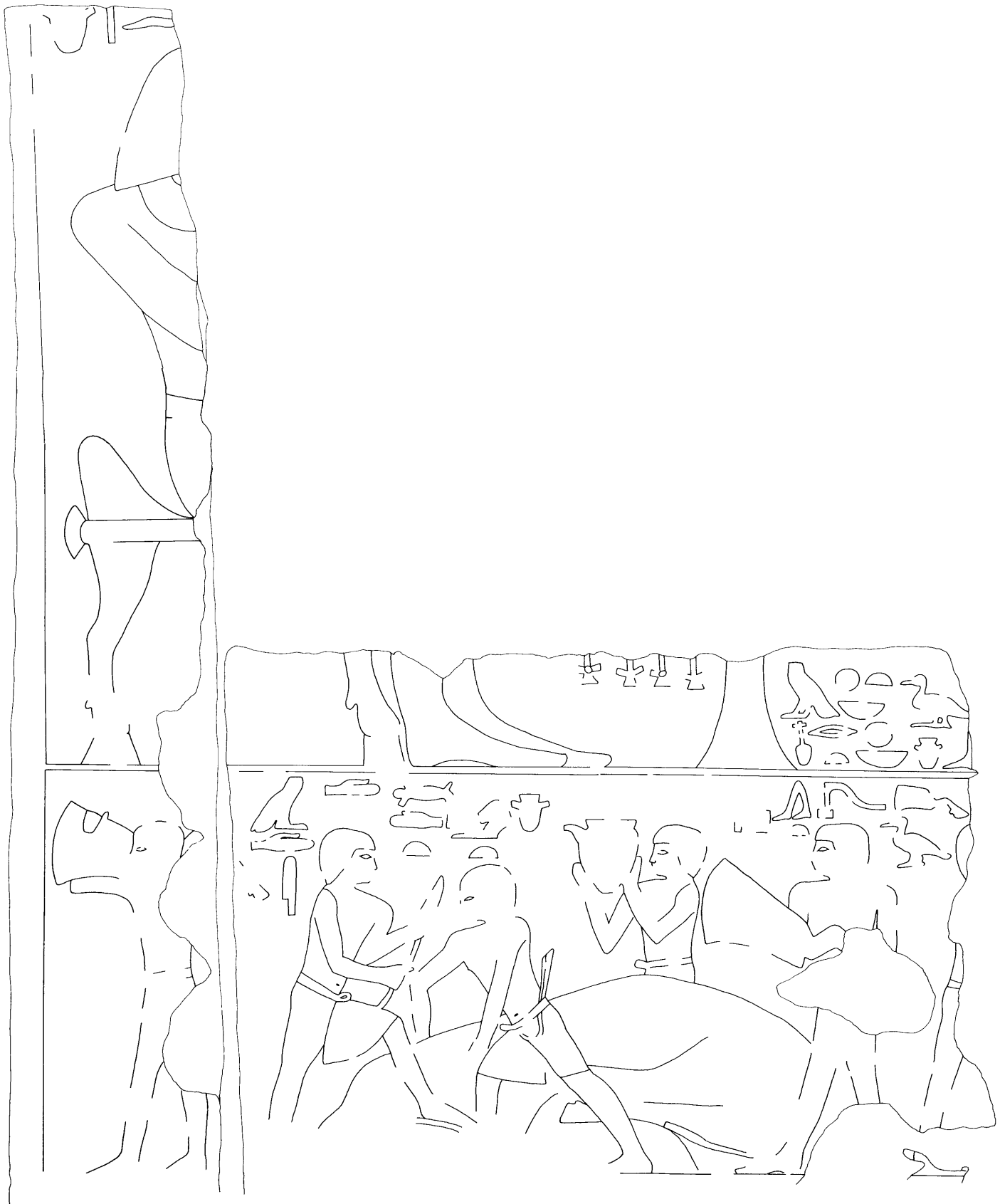

178. 2092+2093: West wall of corridor south of recess and north of false door. (See pls. 70b, 70c, 71a)

0 5 10  
cm (1:5)

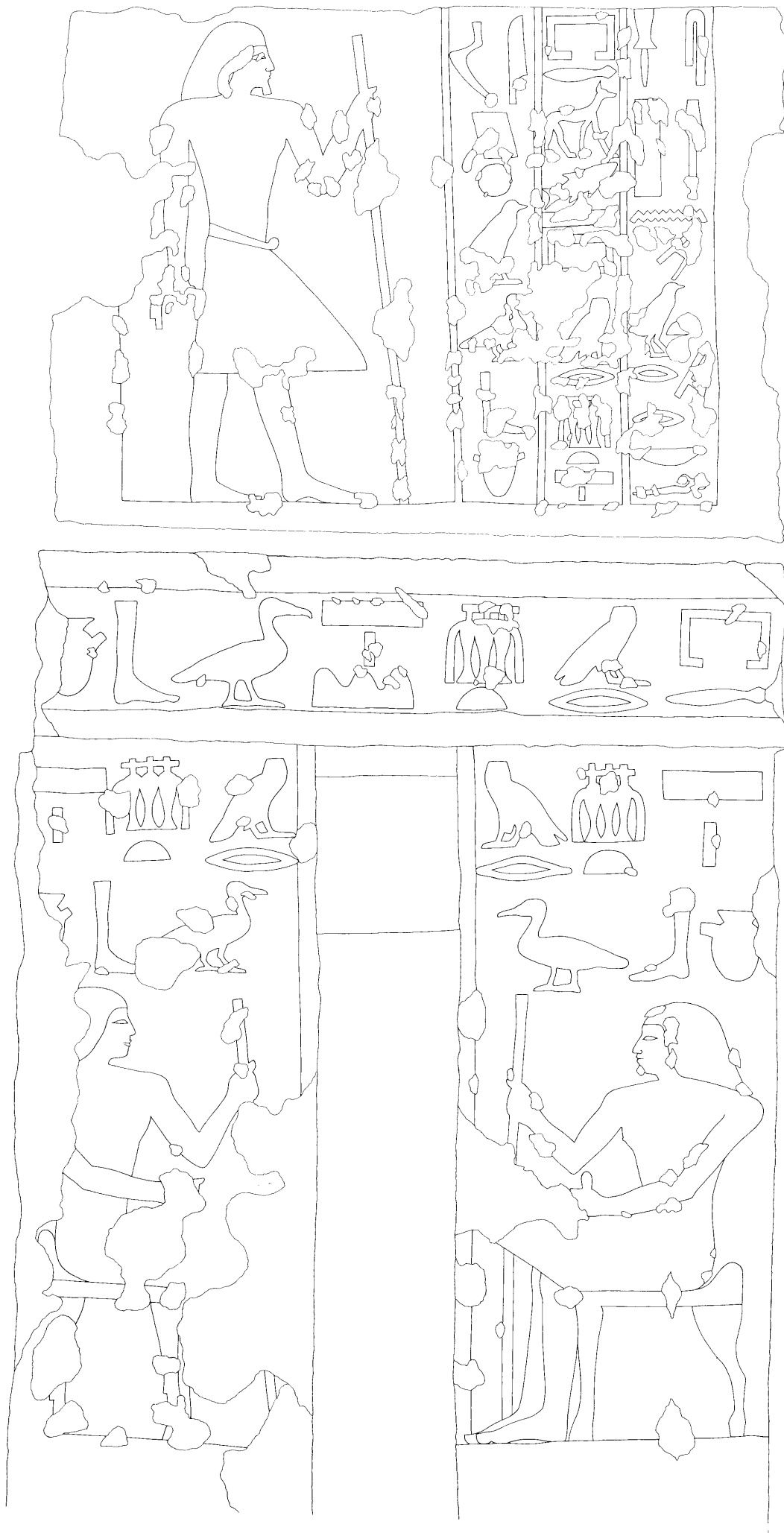

179. 2092+2093: False door in west wall of corridor. (See pls. 71b, 72a)

0 5 10  
cm (1:5)



180. 2092+2093: South wall of corridor. (See pl. 72b)

0 5 10  
cm (1:5)

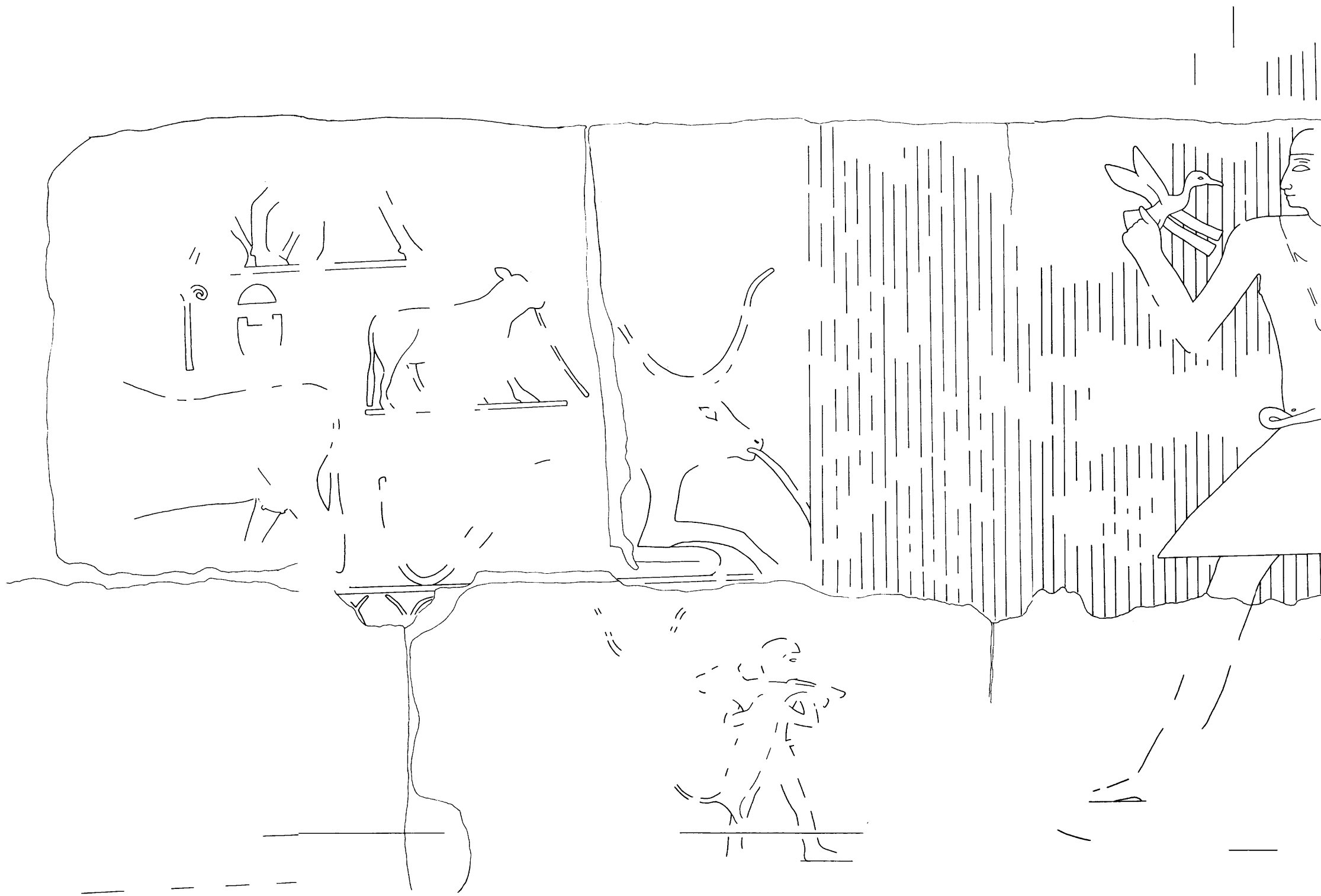

181. 2092+2093: East wall, south end. (See pls. 73a, 73b)

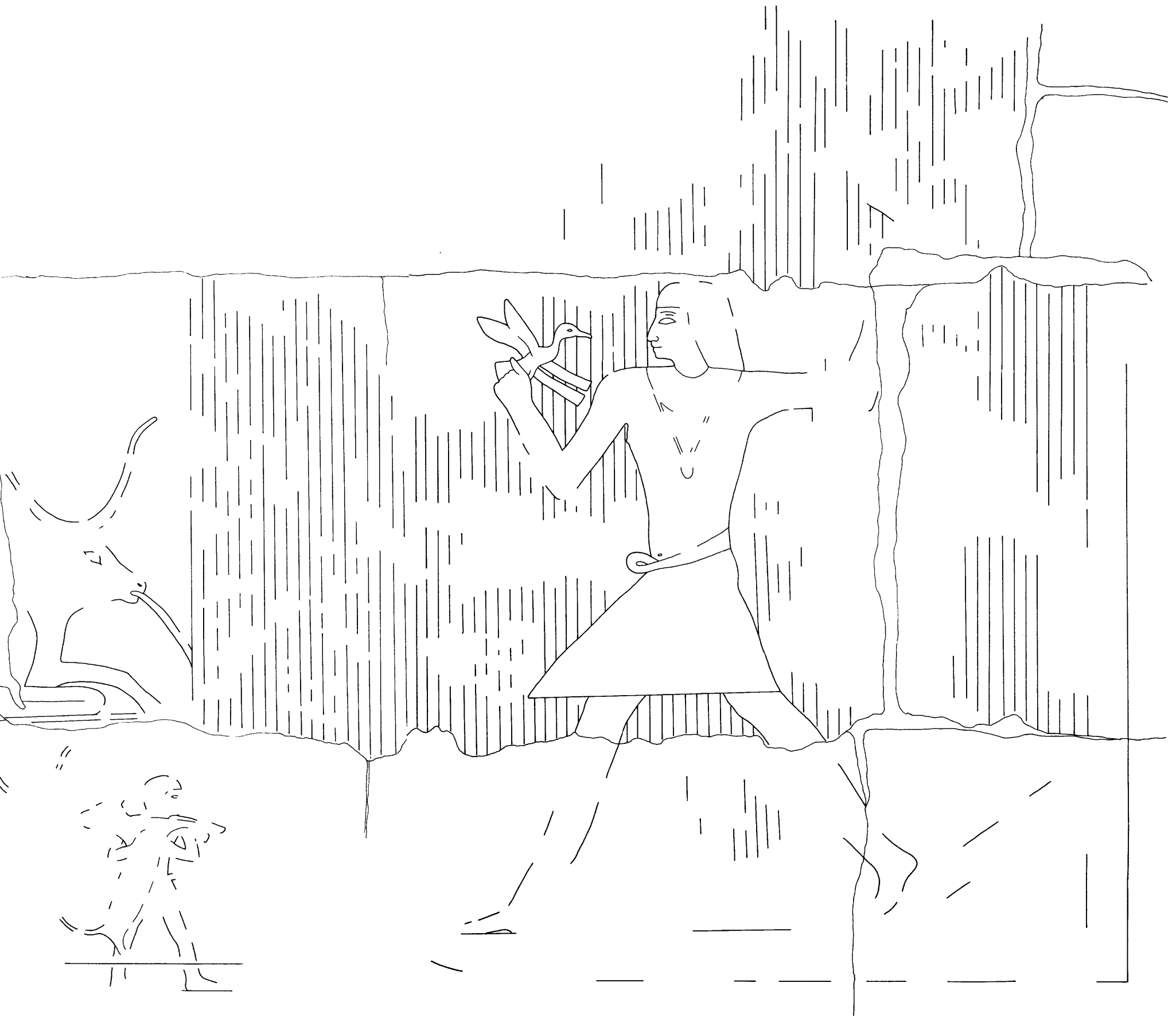

0 5 10  
cm (1:5)



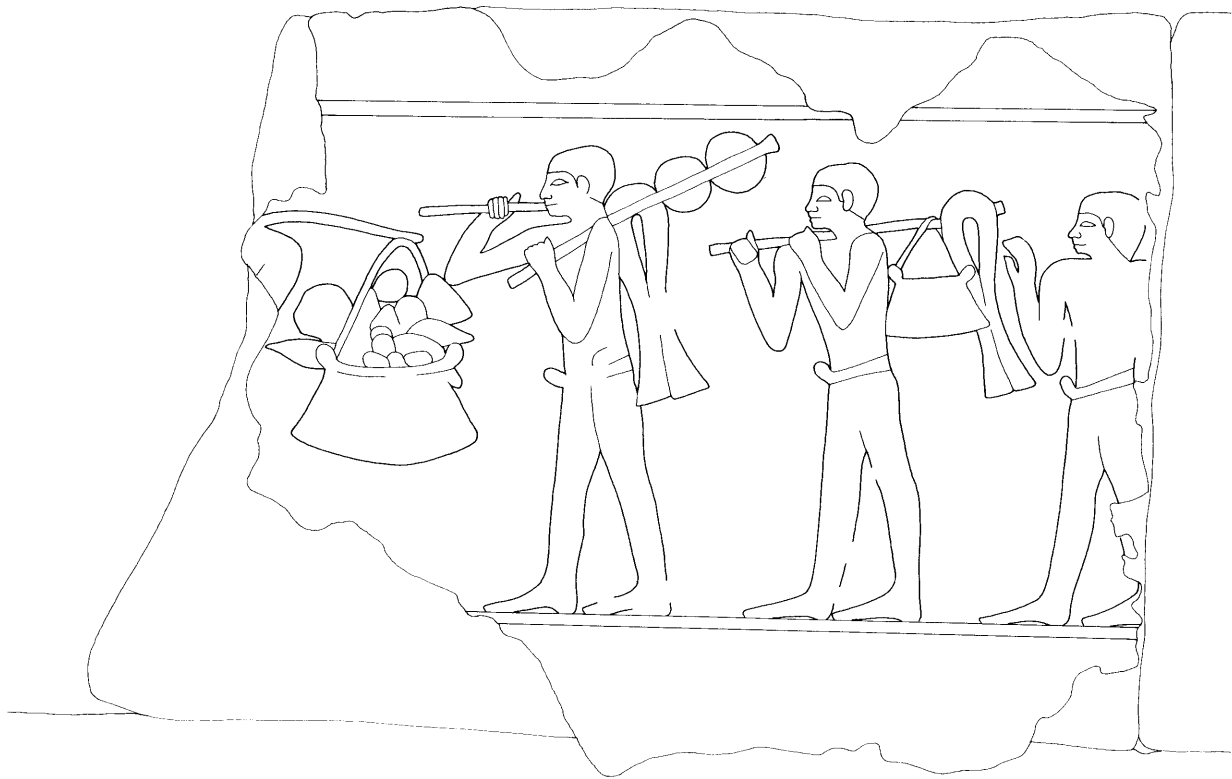

182. 2092+2093: East wall, third segment from south. (See pl. 74a)

scale not determinable



183. 2092+2093: East wall, north end. (See pls. 74b, 75a)

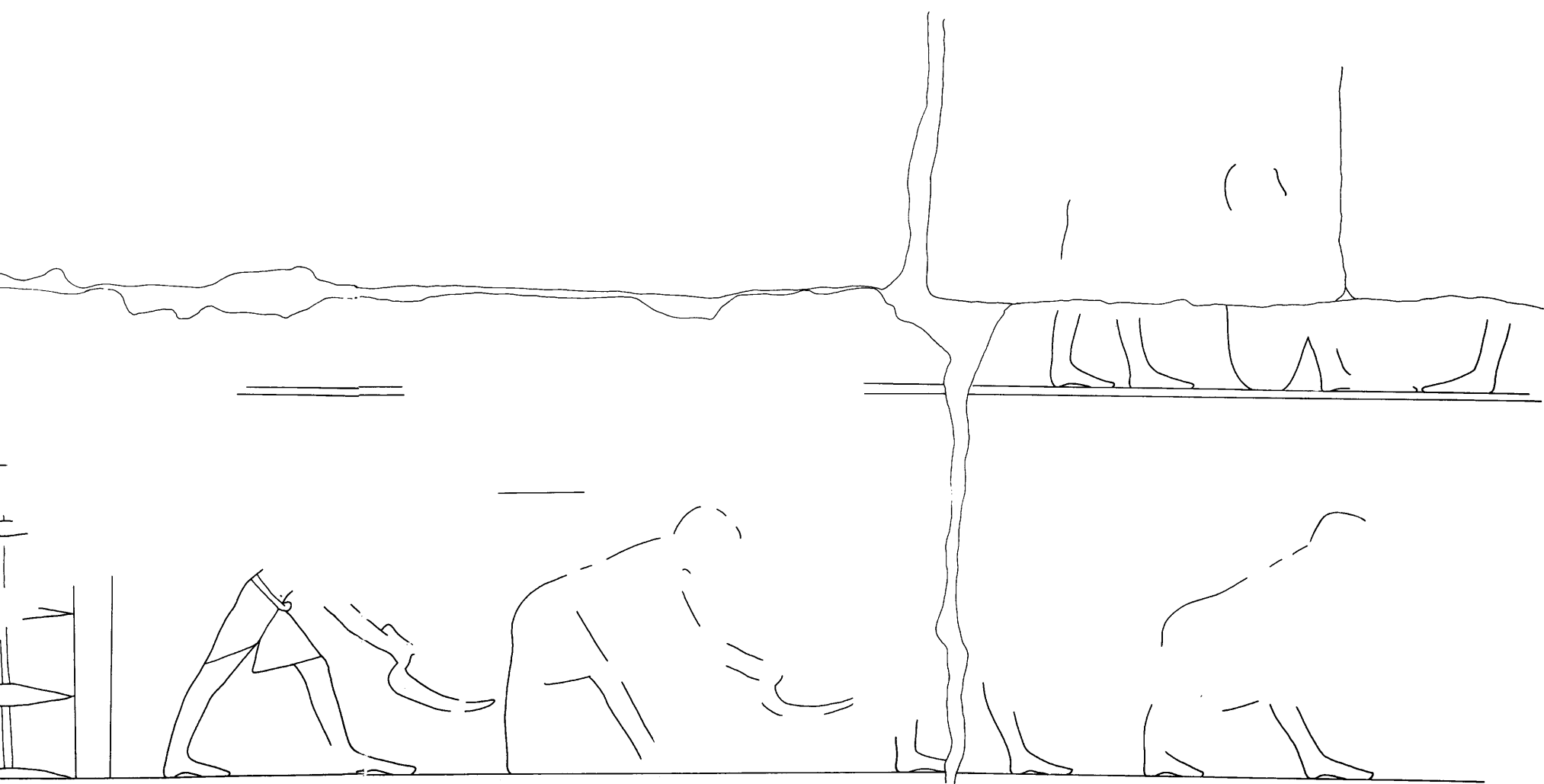
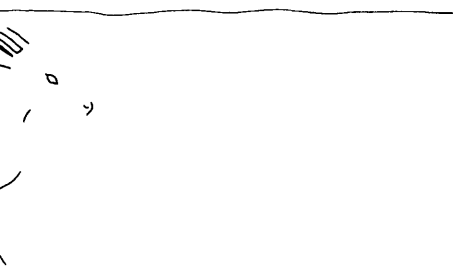

0 5 10  
cm (1:5)

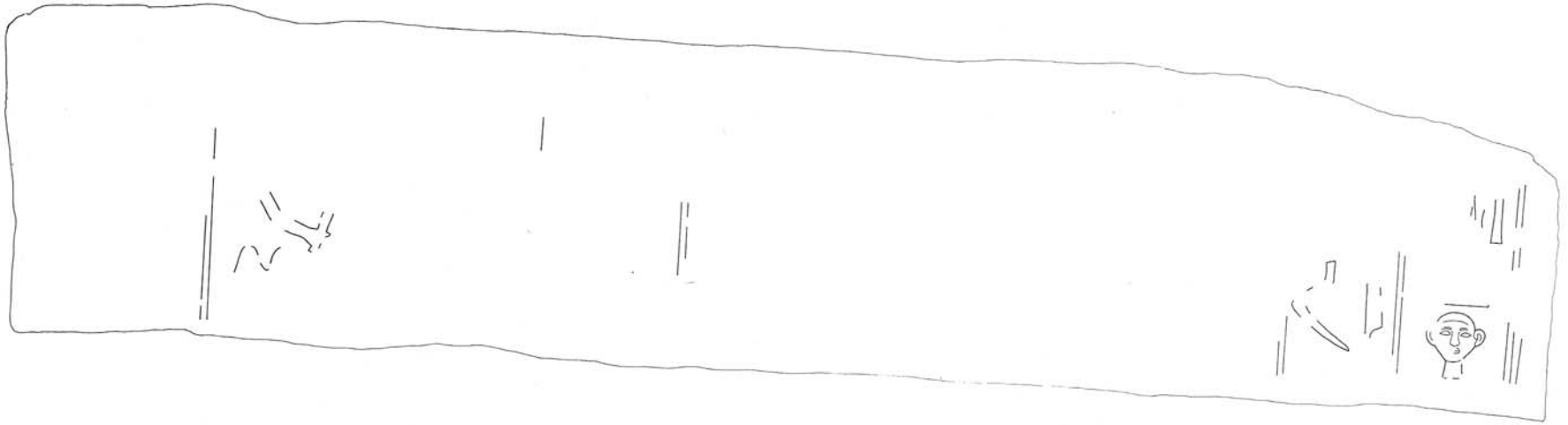

184. 2097: Loose block, almost certainly to be restored above west end of north wall. (See pl. 88a)

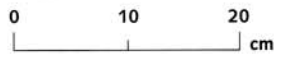

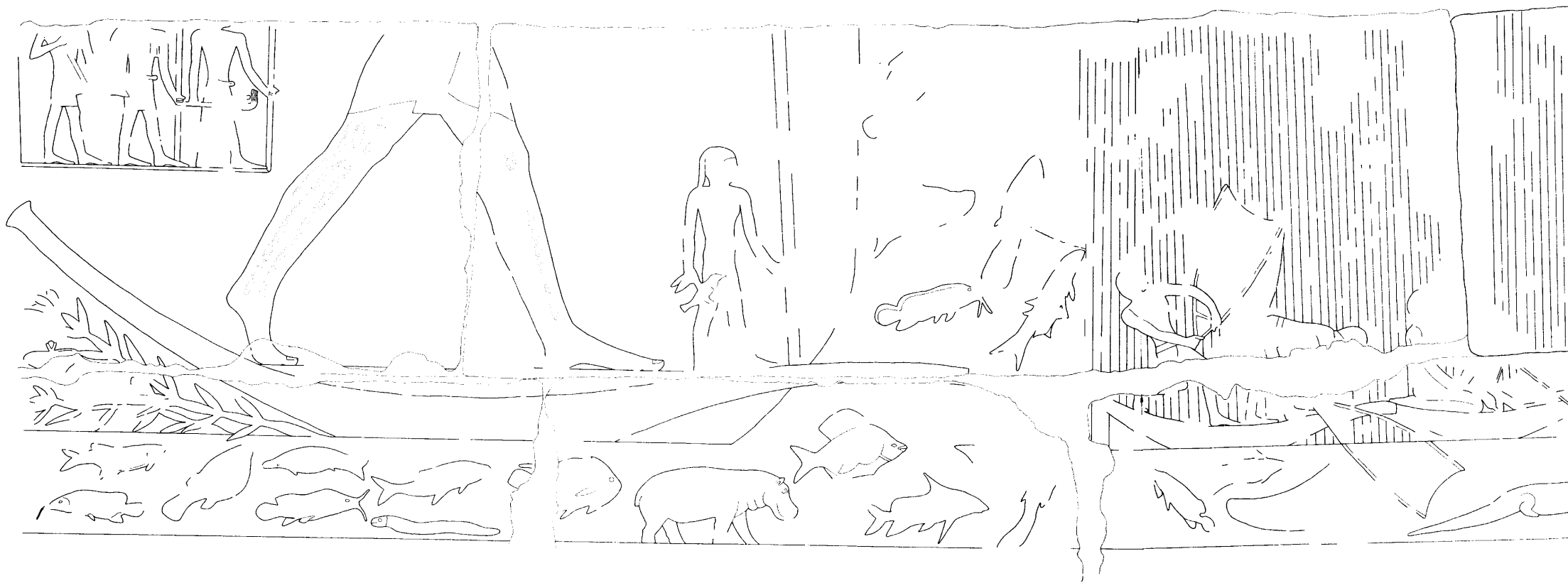

185. 2097: North wall of chapel. (See pls. 87, 88b, 89)

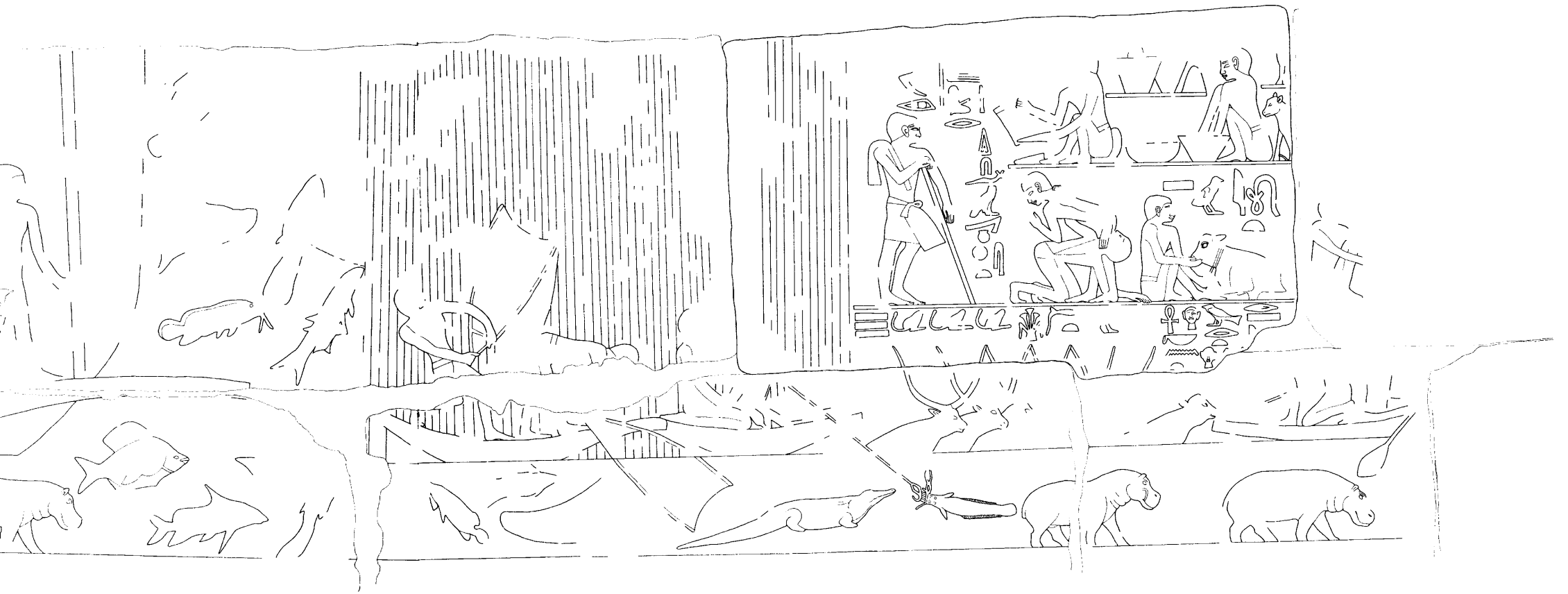

0 10 20  
cm

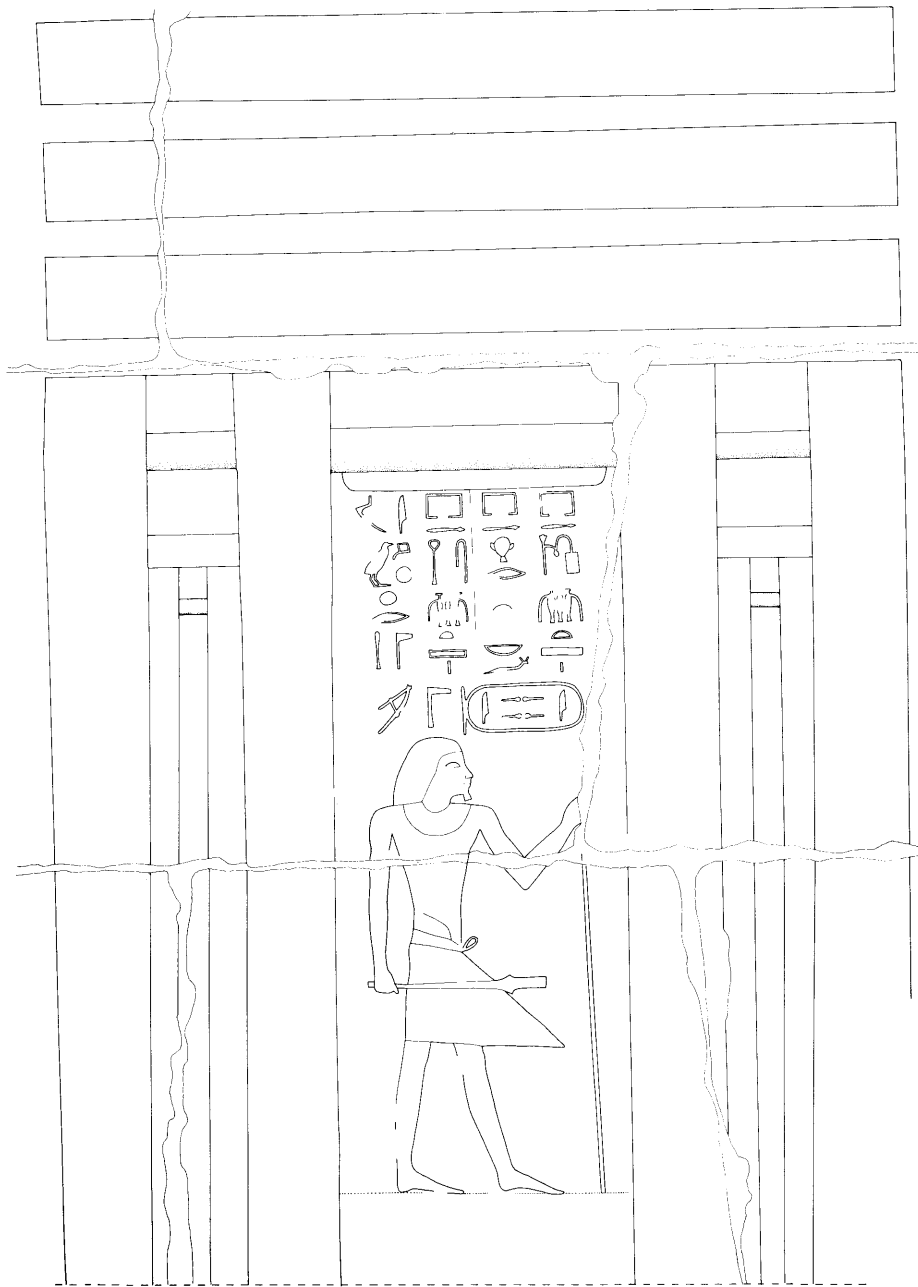

186. 2097: Intrusive inscription on palace facade door, west wall of chapel. (See pls. 90, 91)

0 10 20  
cm

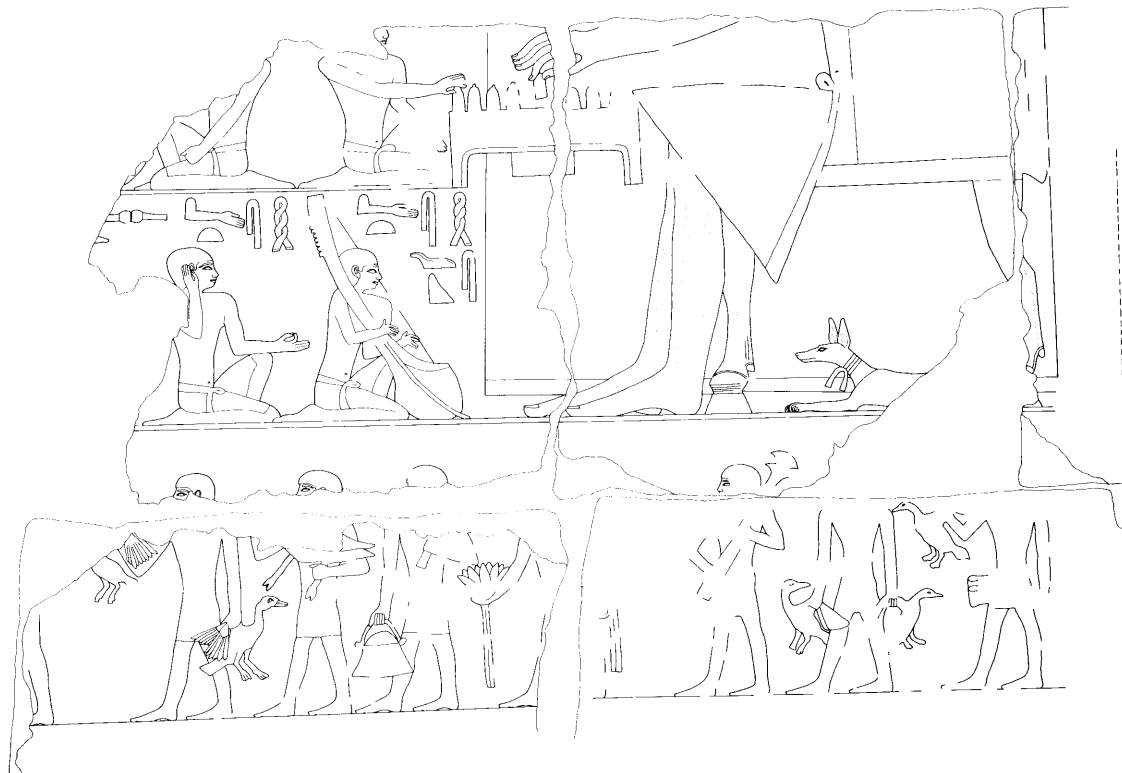
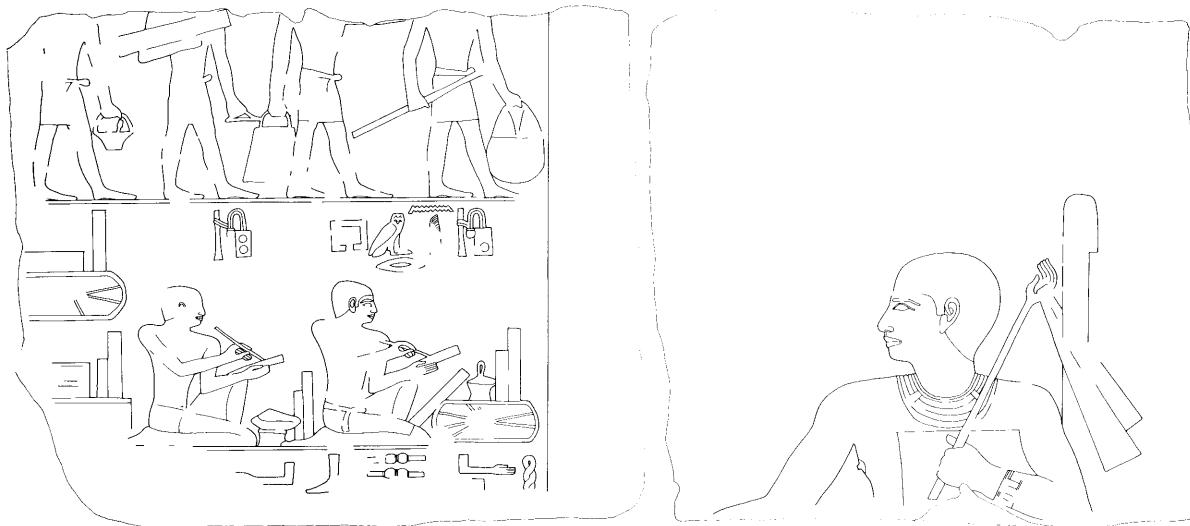
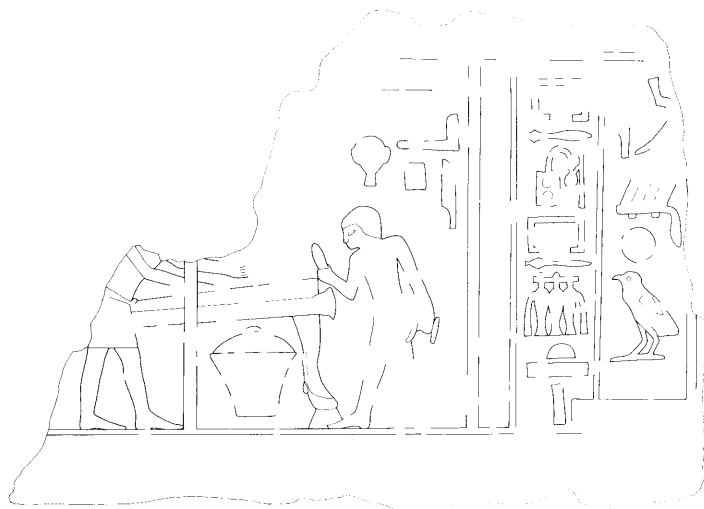

187. 2097: South wall of chapel recess. (The upper left block is a loose block from the top of 2096 restored to this position. See pls. 92, 93a)

0 10 20 cm



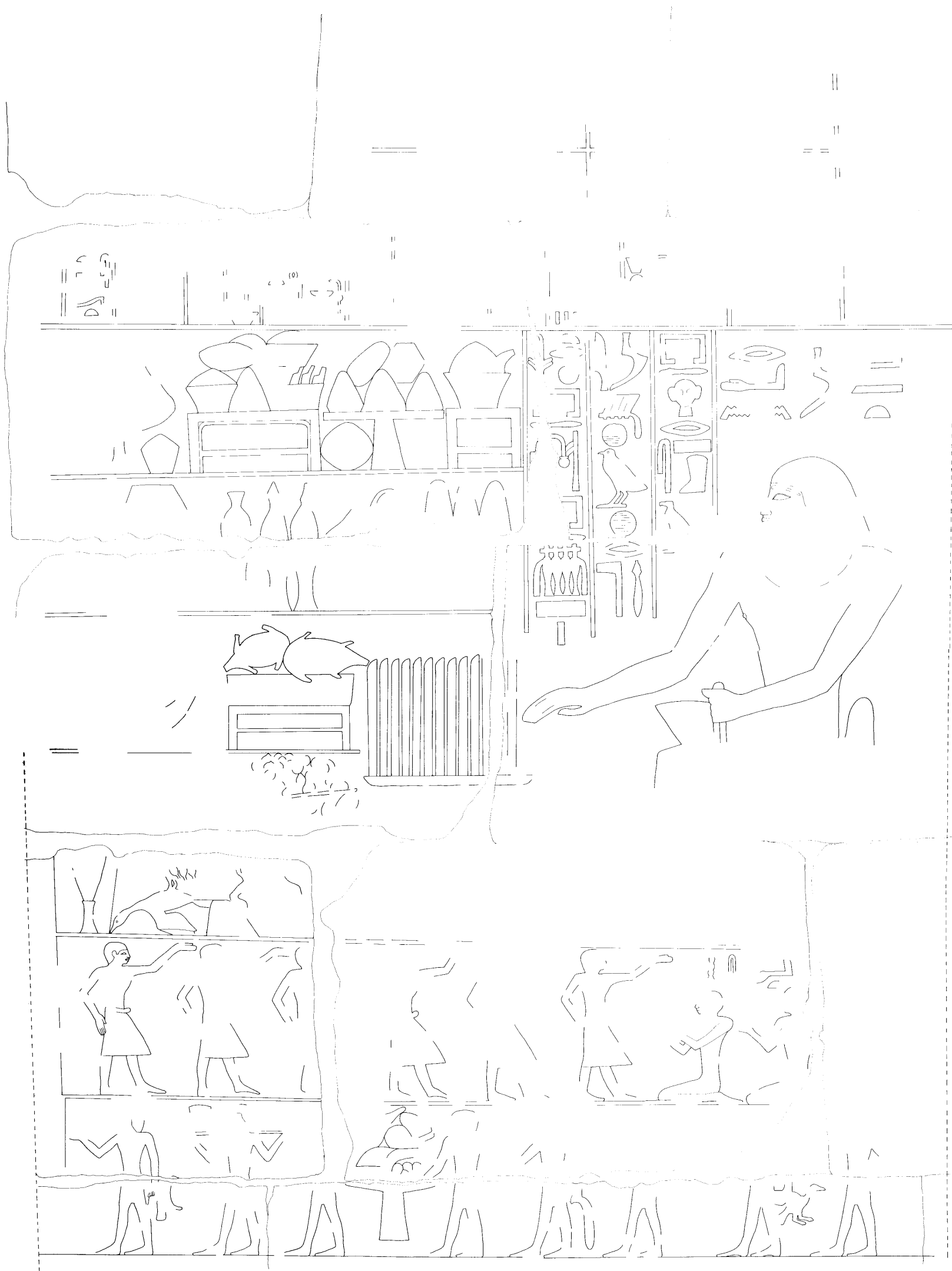

188. 2097: South wall of corridor. (See pls. 93b, 94)

0 10 20  
cm

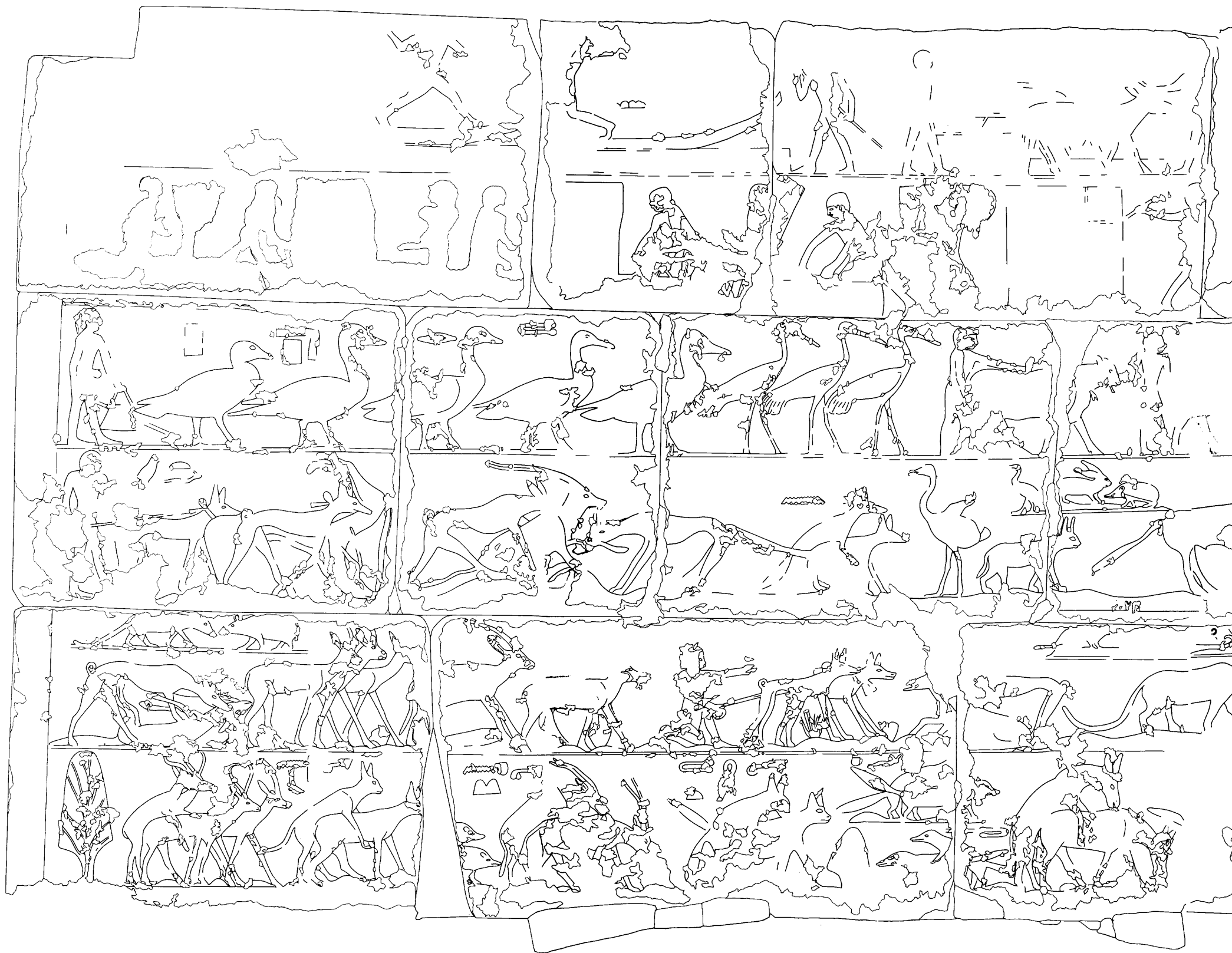

189. 2097: East wall of chapel. (See pls. 95, 96, 97)

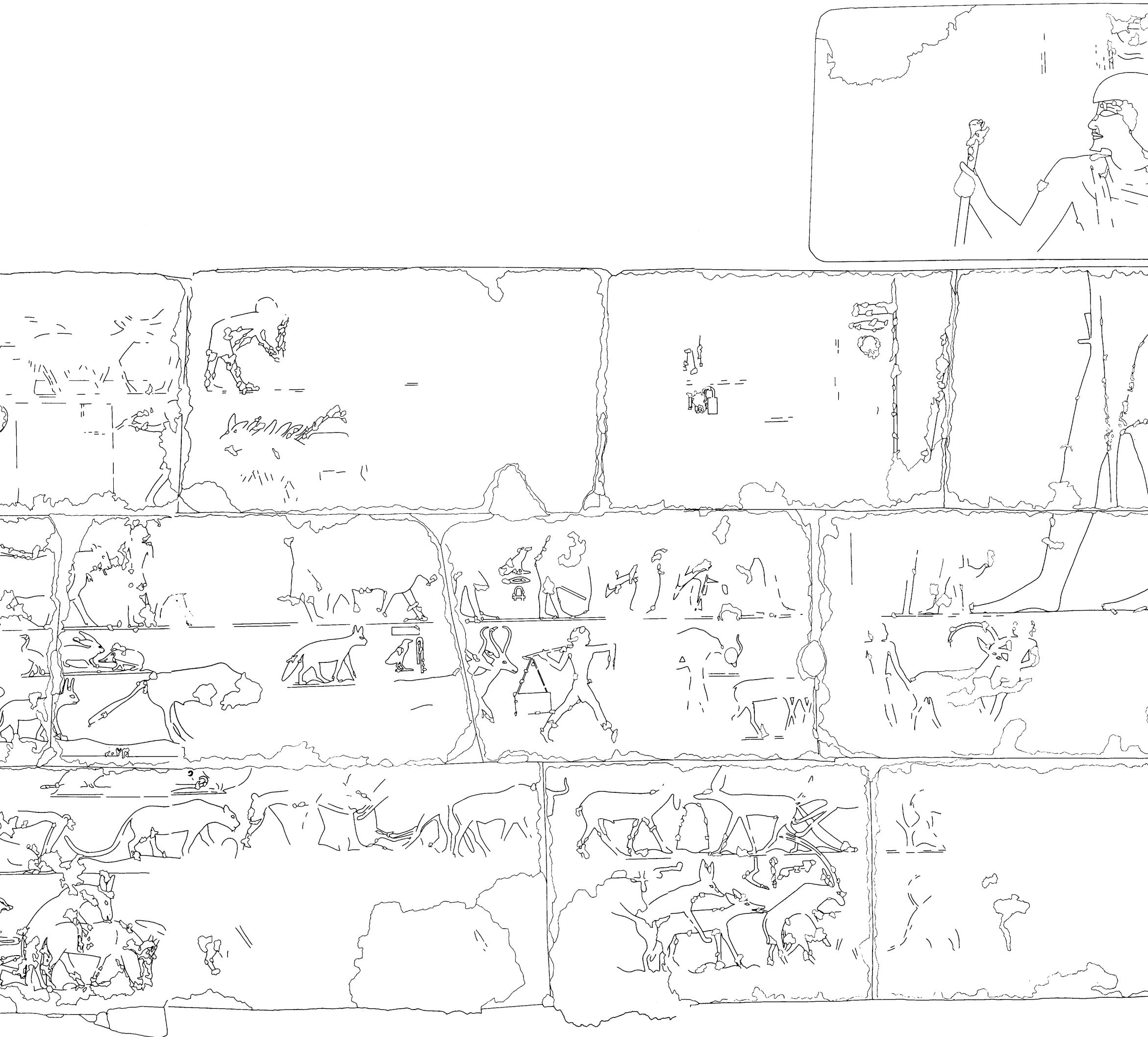

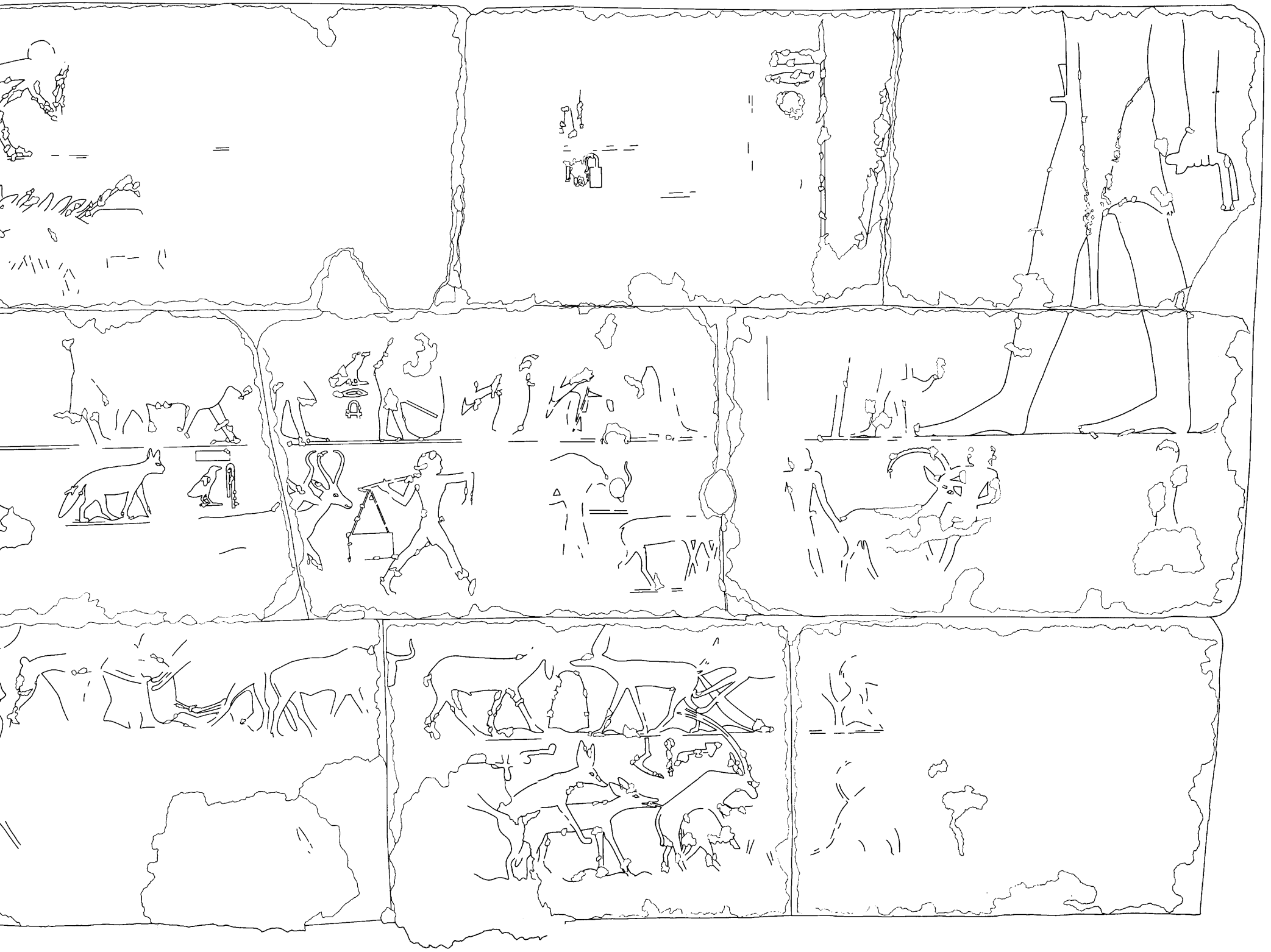
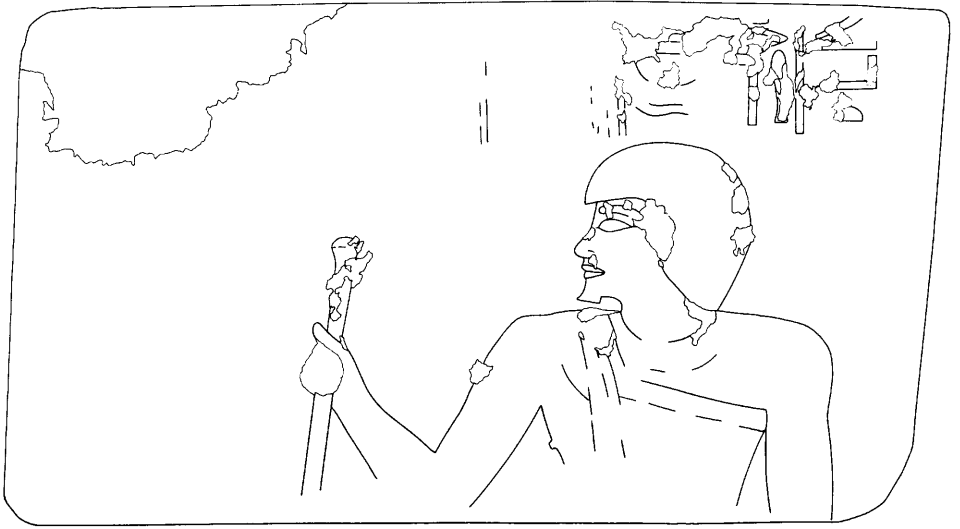

0 10 20 cm



190. 2097': Northern false door tablet. (See pl. 98b)

0 5 10  
cm

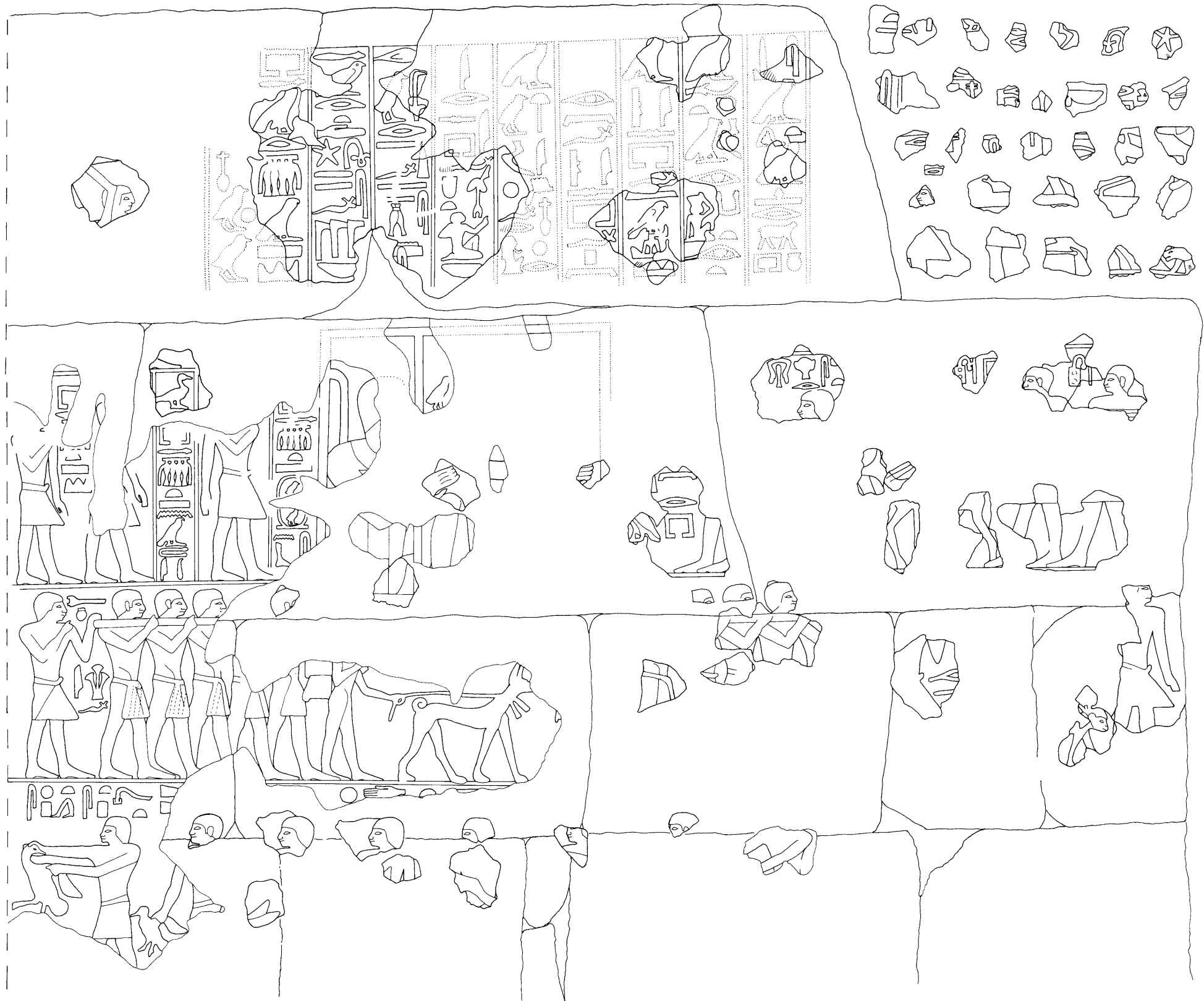

191. 2098: North wall of chapel; unplaced plaster fragments from north wall of chapel. (See pls. 102, 103)

0 10 20  
cm

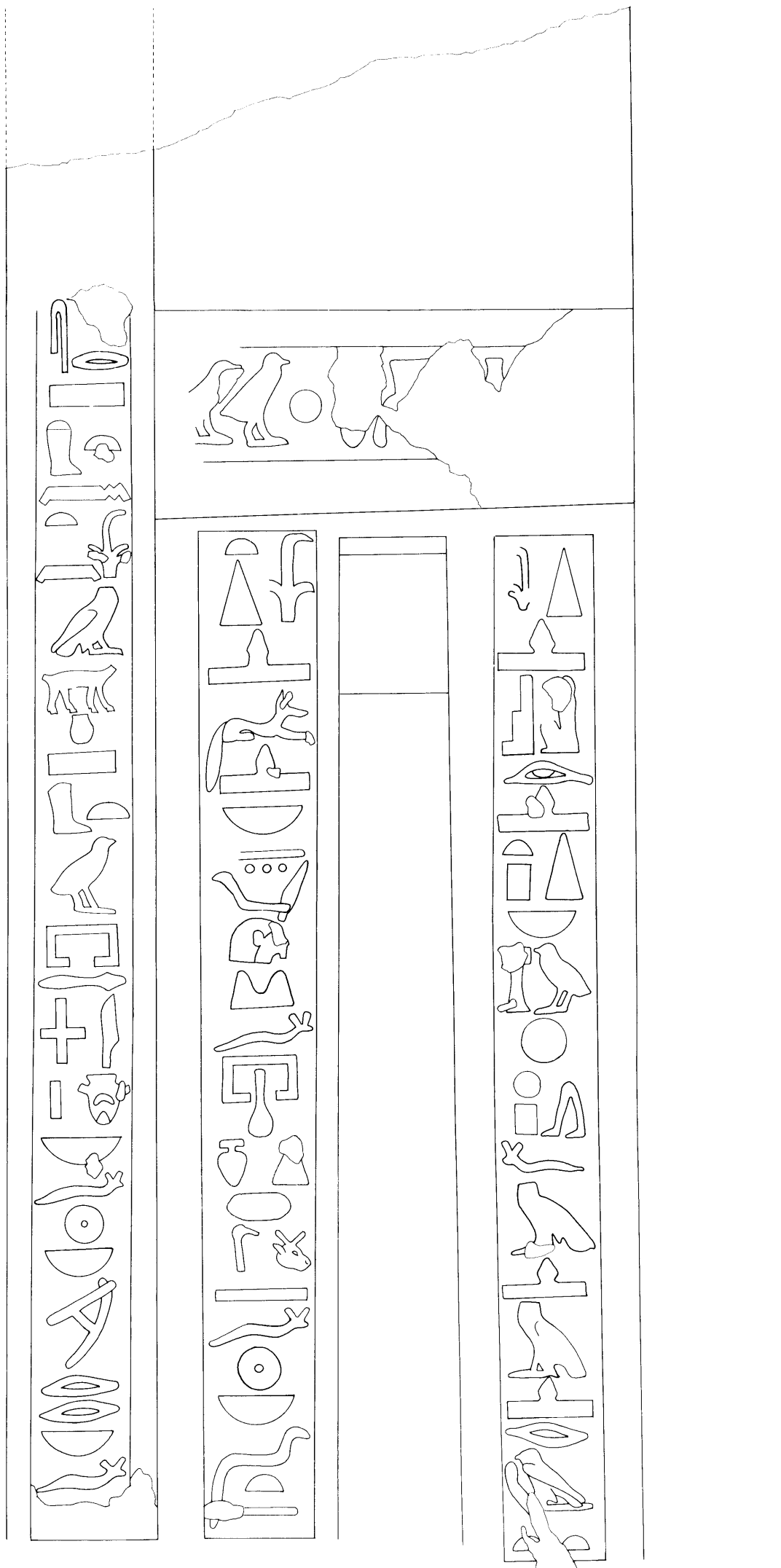

192. 2098: Northern false door of chapel. (The southern false door has been removed. See pl. 105a)

0 5 10  
cm







193. 2098: West wall of chapel, decoration between false doors. (See pls. 105b, 106, 107a)

0 5 10  
cm (1:5)



194. 2098: South wall of chapel. (See pls. 107b, 108a)

0 5 10  
cm

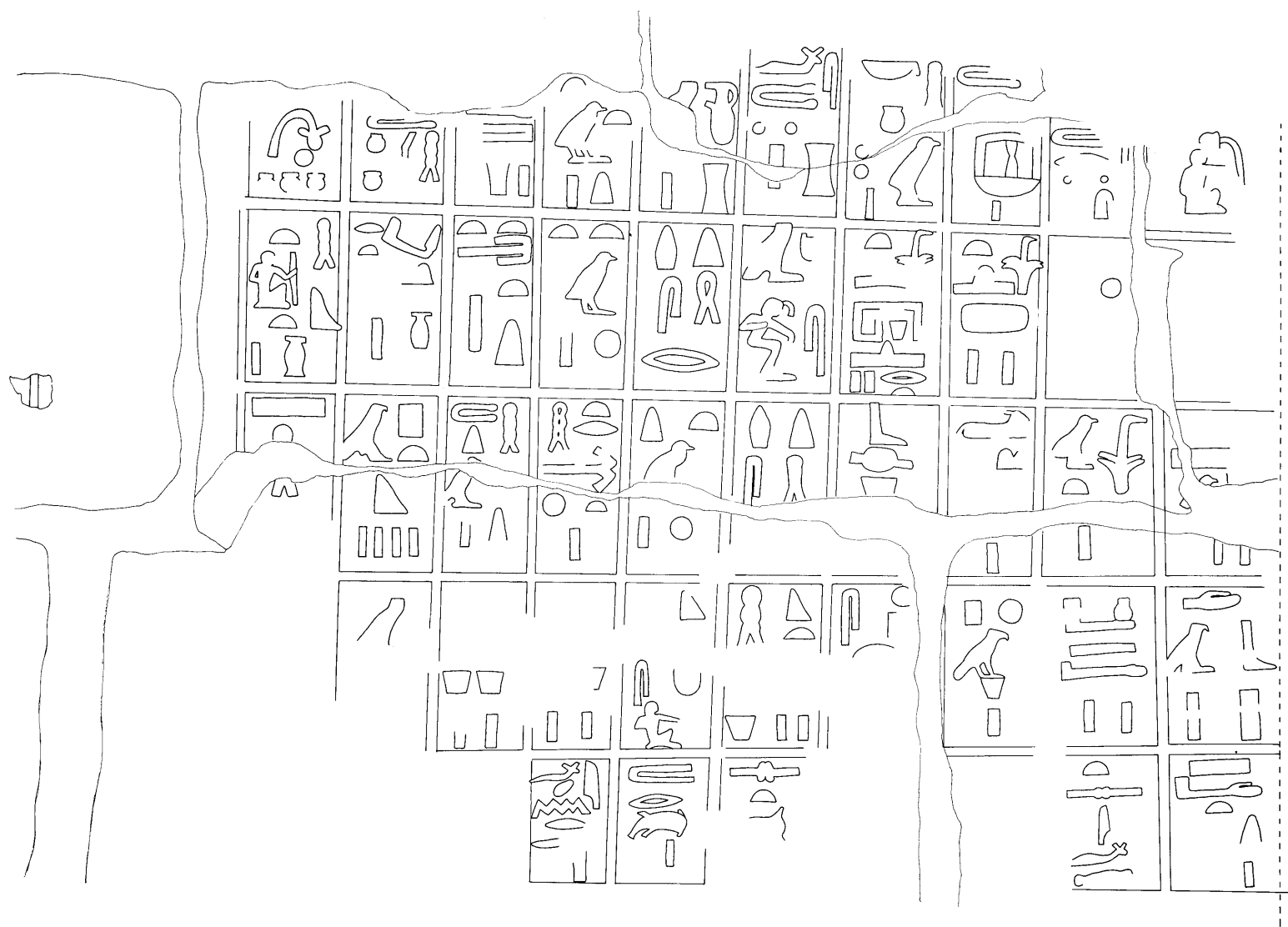

195. 2098: Offering list on west wall of corridor south of chapel recess. (See pls. 108b, 108c)

0 5 10  
cm (1:5)

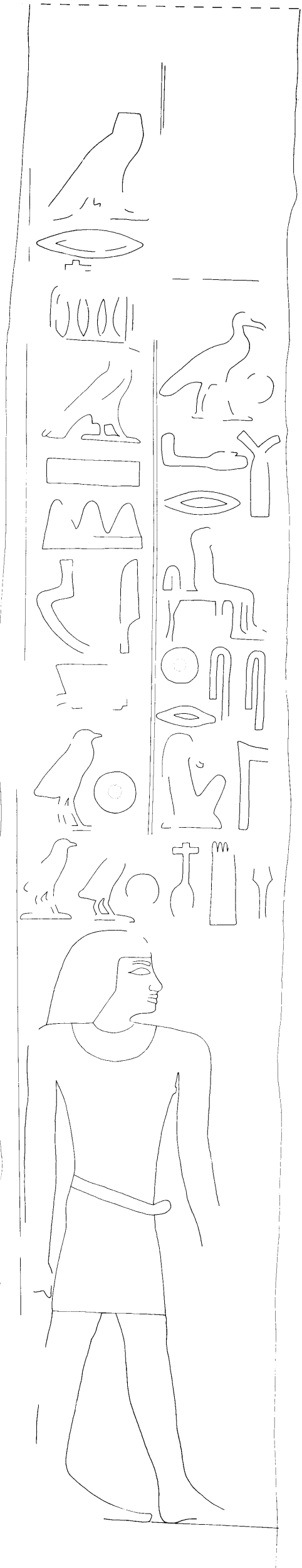

196. 2098: Two of three decorated faces of pillar. (See pl. 109)



197. 2098: One of three decorated faces of pillar. (See pl. 109)

0 5 10  
cm (1:5)

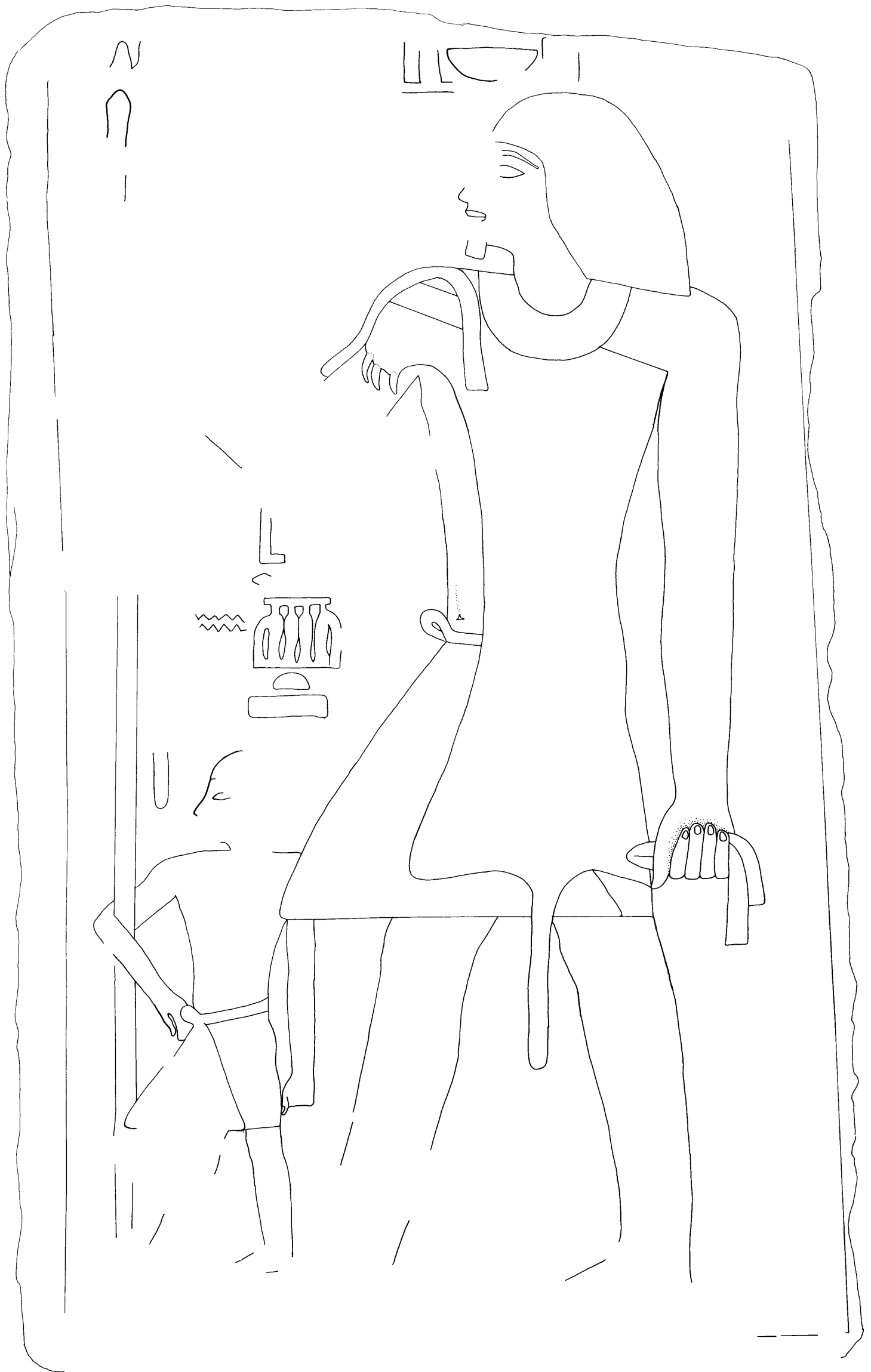

198. 2098: Loose block found in tomb, presumably a doorjamb

0 5 10  
cm

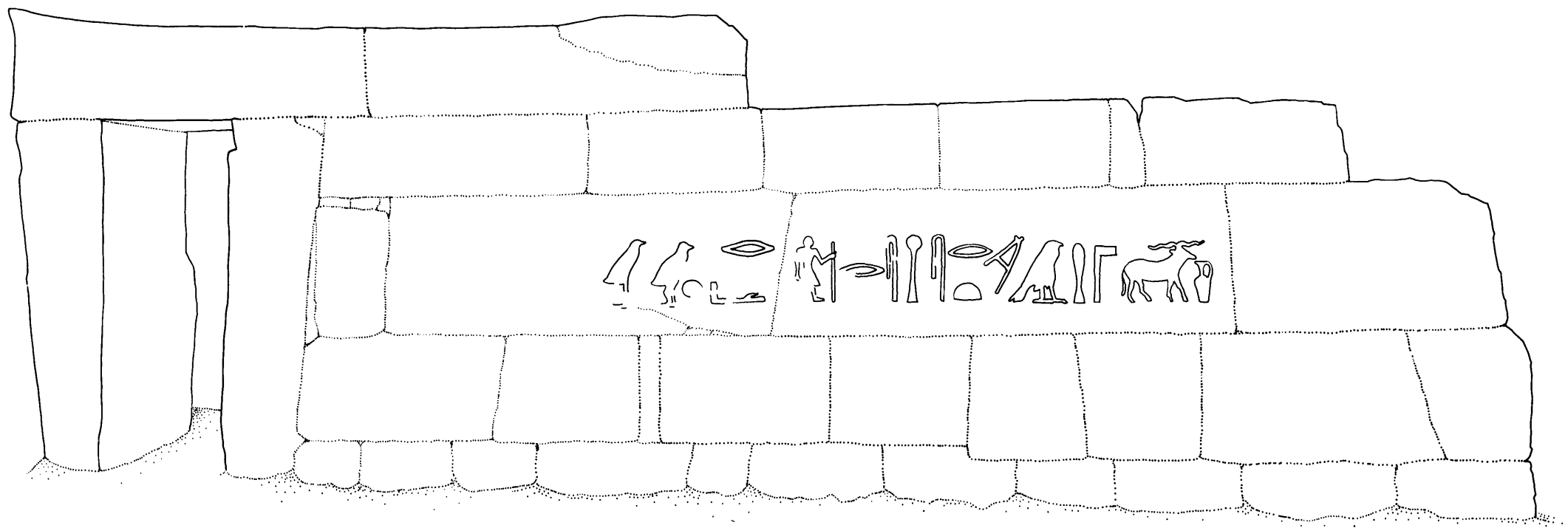

199. 2230+2231: Southern facade of mastaba 2231, showing inscription (probably intrusive). (See pl. 118c)

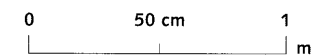



200. 2230+2231: Unfinished relief on eastern doorjamb at southern entrance to chapel. Light dashed lines = red paint

0 5 10  
cm (1:5)



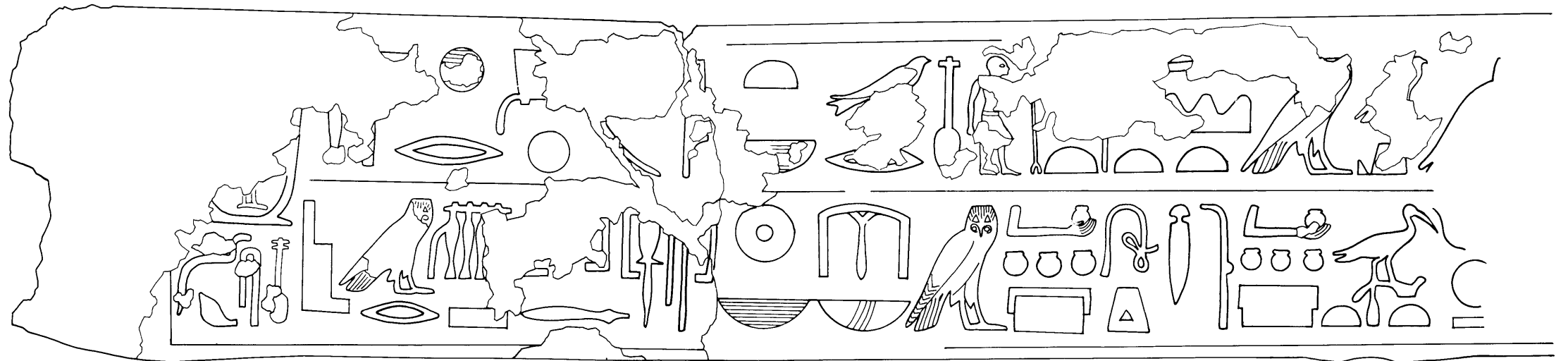
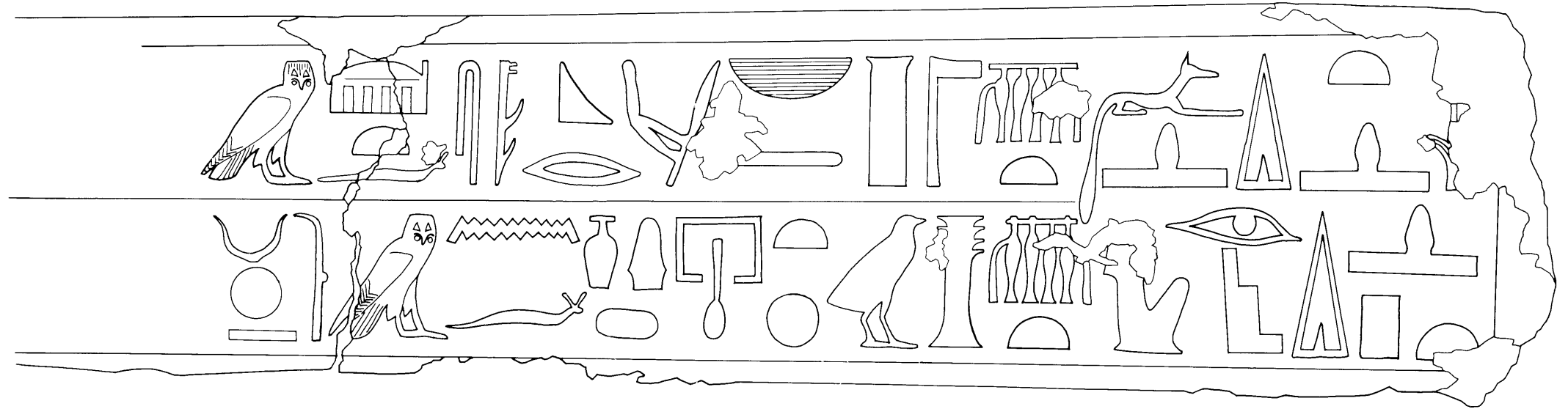

201a, b. 2240: Architrave from portico. (See pl. 122)

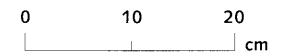

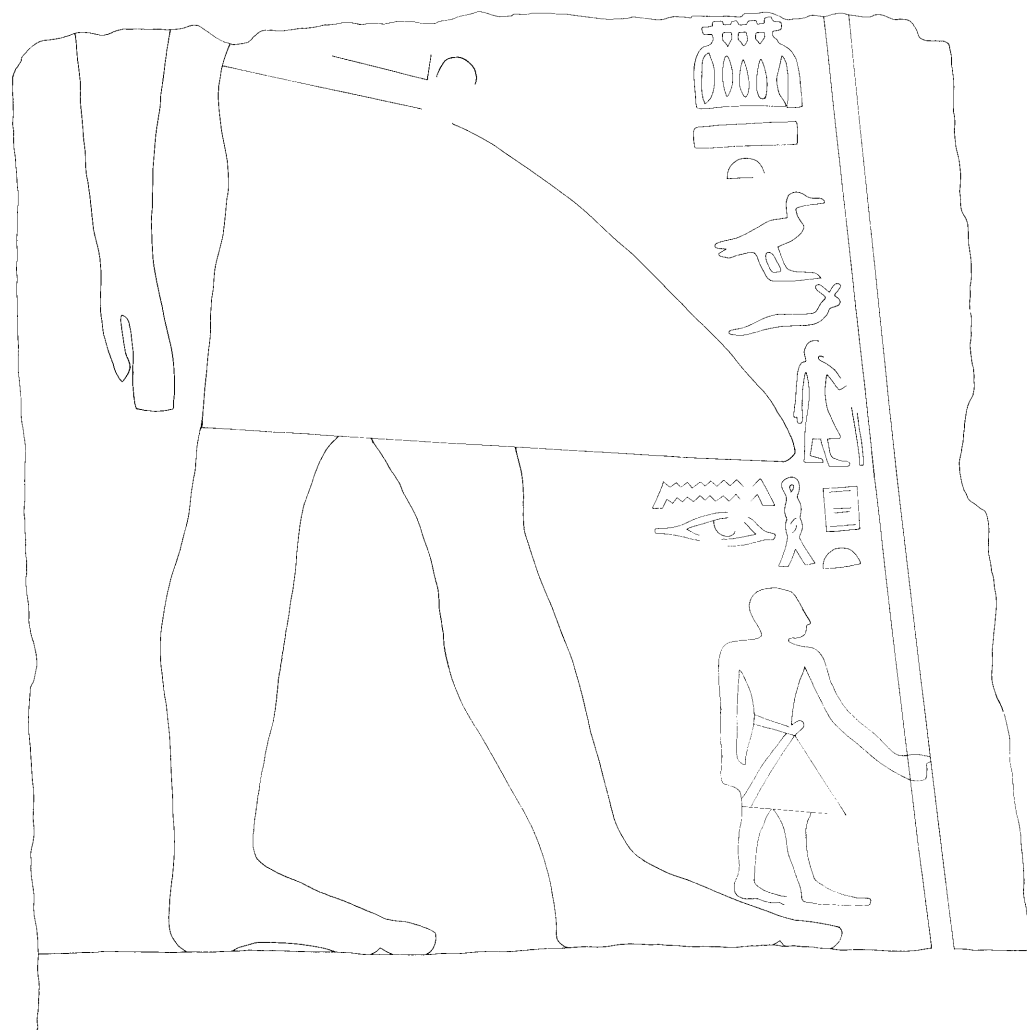

202. 2240: Jamb of entrance. (See pl. 123b)

0 5 10  
cm (1:5)



203. 2240: Jamb of entrance. (See pl. 123a)

0 5 10  
cm (1:5)

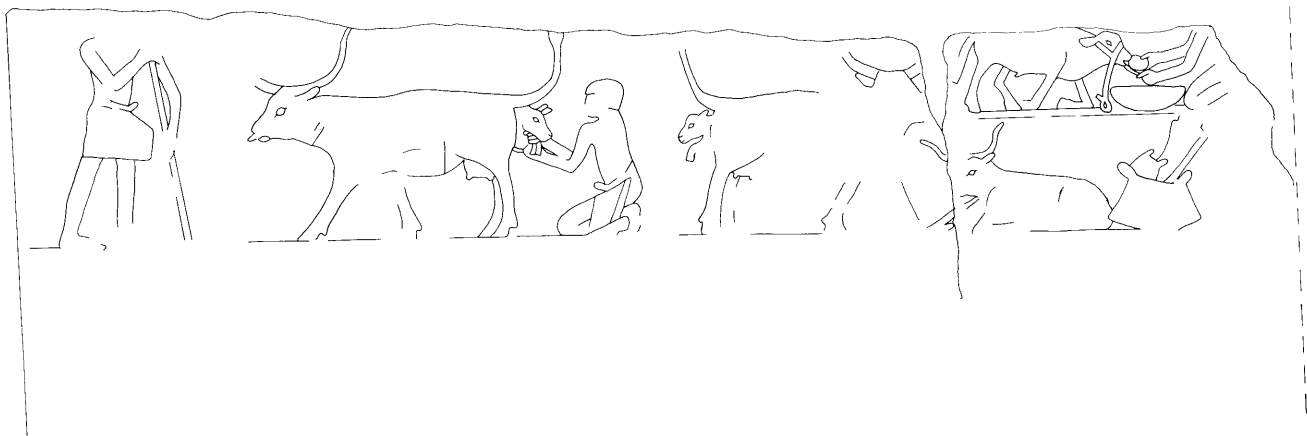

204. 2240: North wall of chapel. (See pl. 124a)

0 10 20  
cm

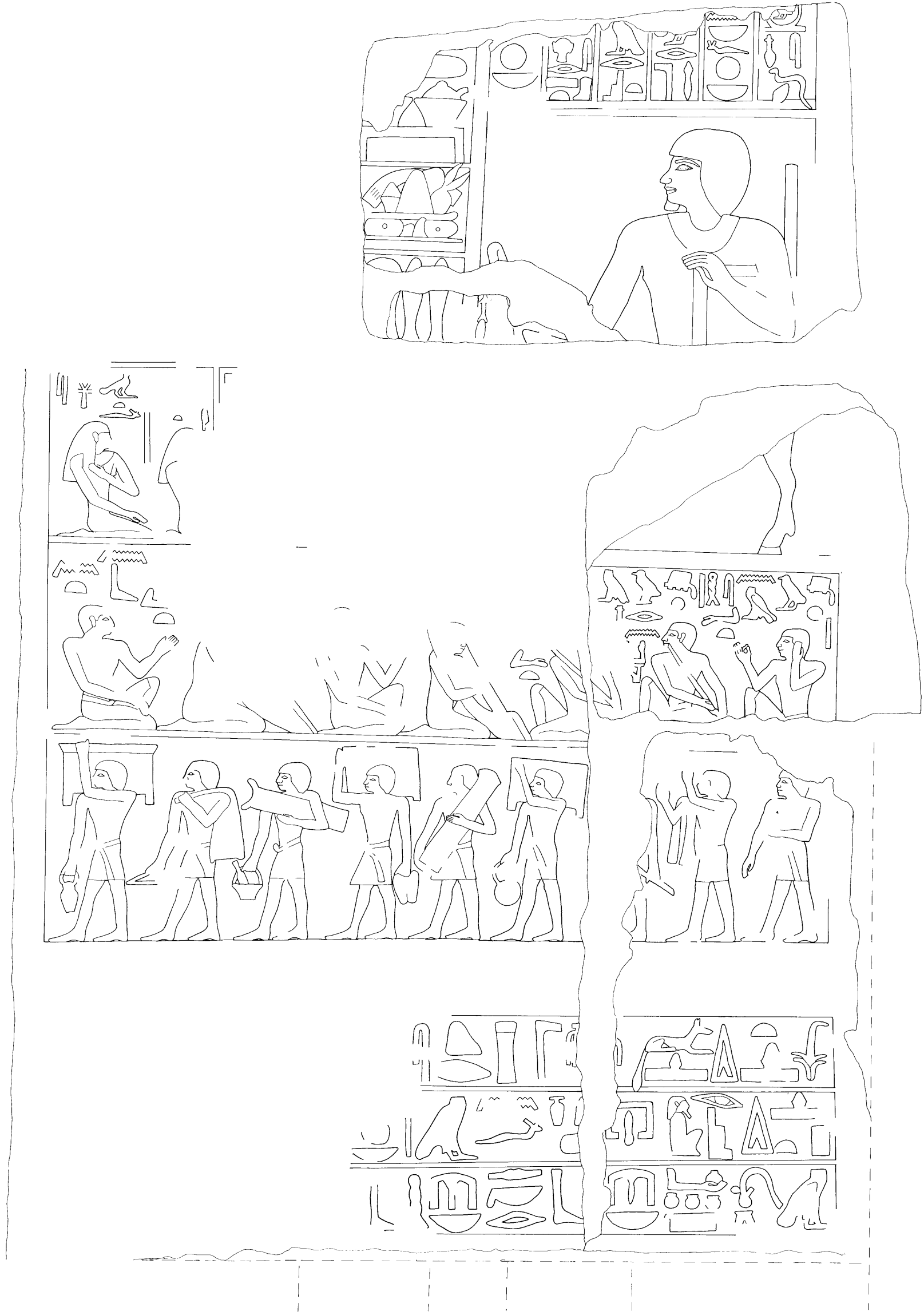

205. 2240: West wall, north end. (See pls. 125, 126a)

0 10 20 cm

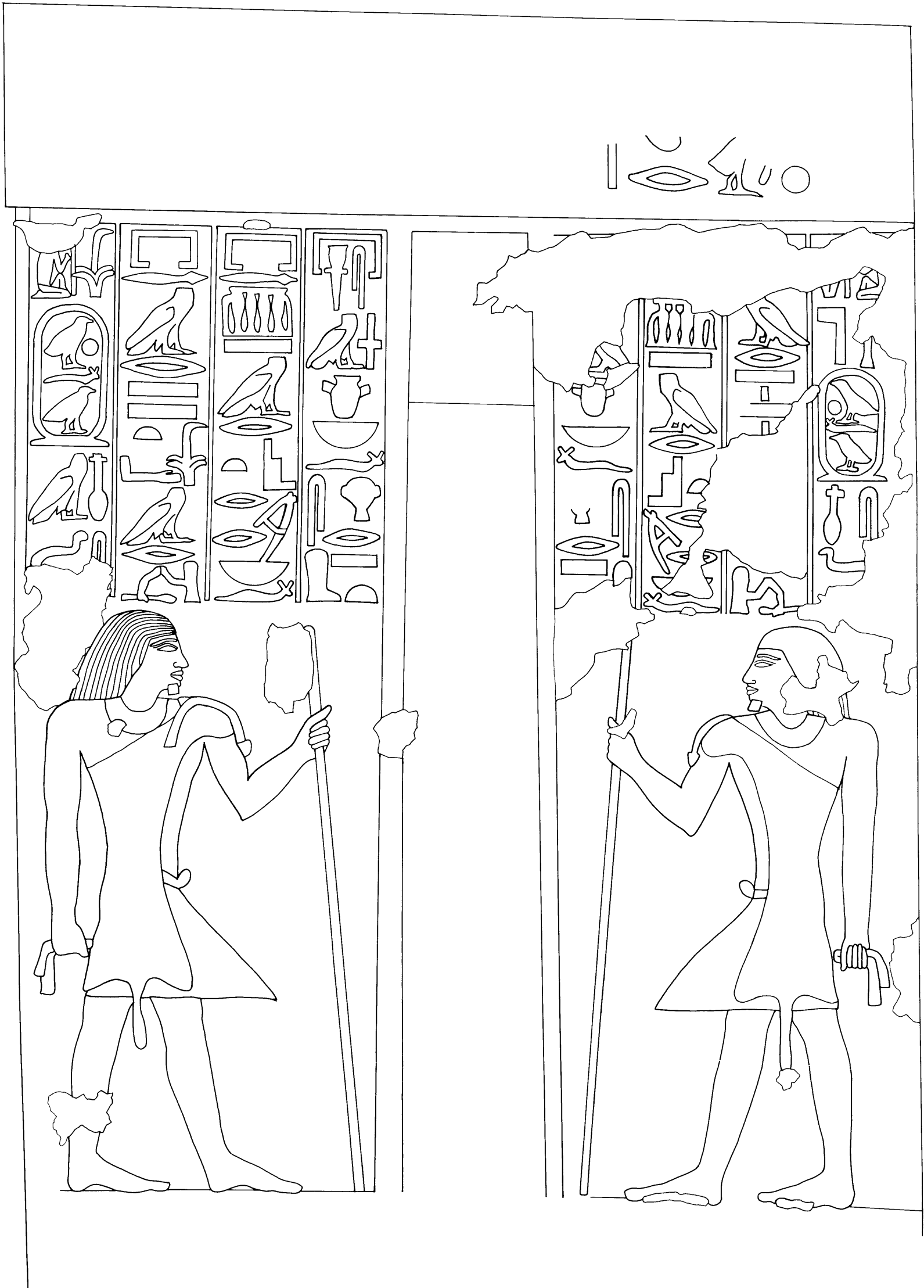

206. 2240: West wall, central false door. (See pl. 126b)

0 10 20 cm



207. 2240: West wall, south end. (See pl. 127)

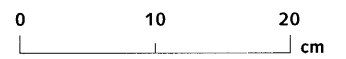

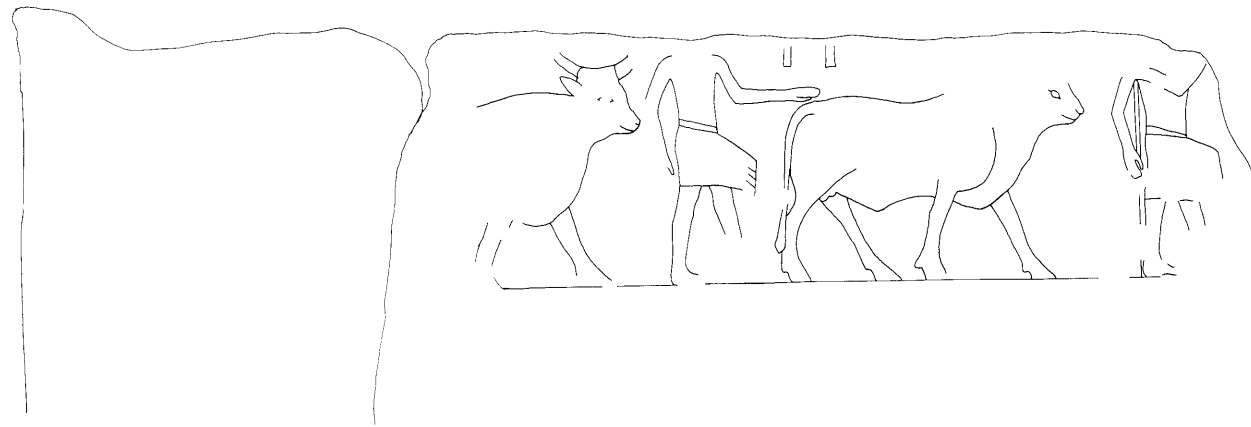

208a. 2240: South wall. (See pl. 128a)

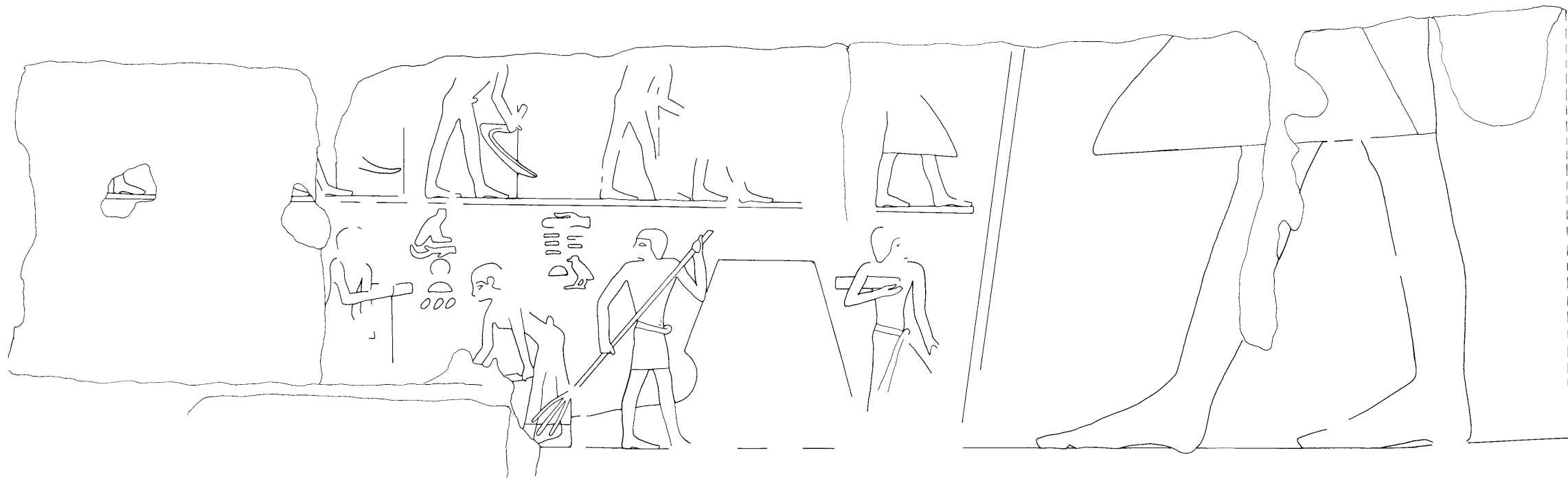
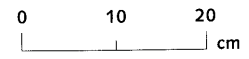

208b. 2240: East wall. (See pls. 128b, 129a)

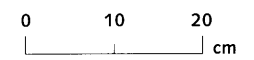



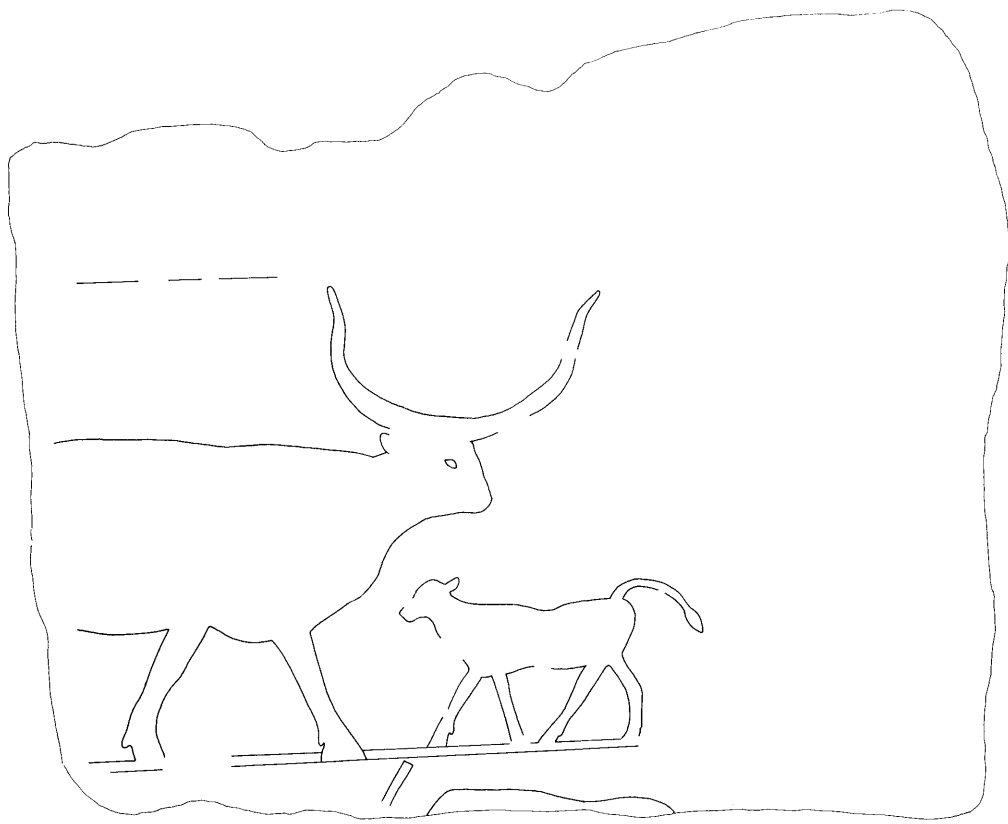

209. 2240: Loose blocks

0 5 10  
cm (1:5)

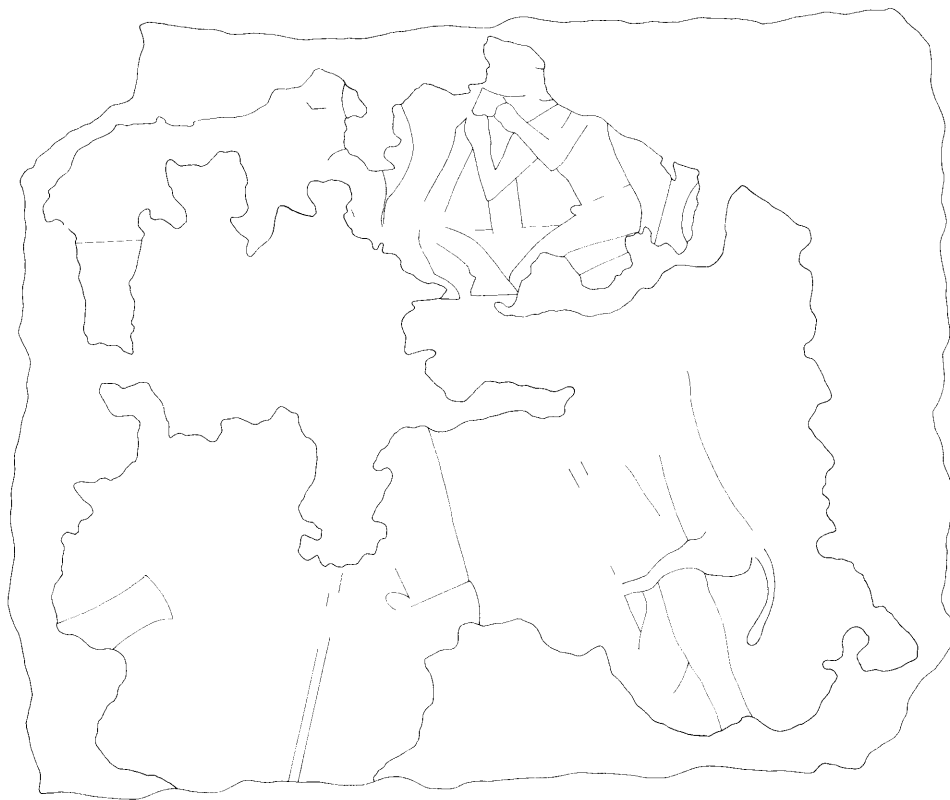

210. Loose block of unknown provenience

0 5 10  
cm (1:5)