

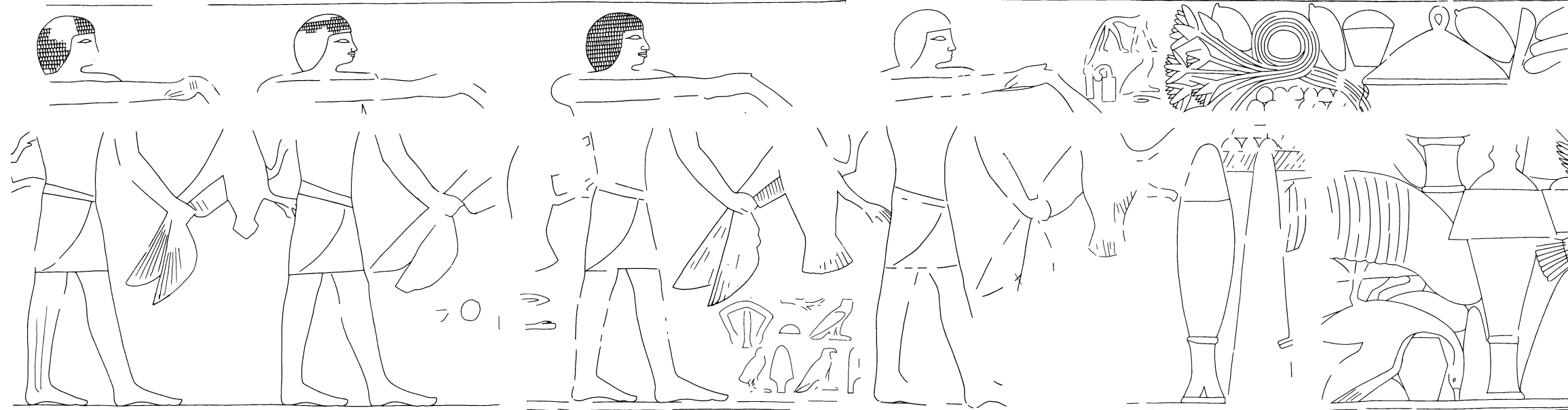

61. Senedjemib Inti (G 2370), Room IV, south wall. EG 4412-4418, 4385, 4521

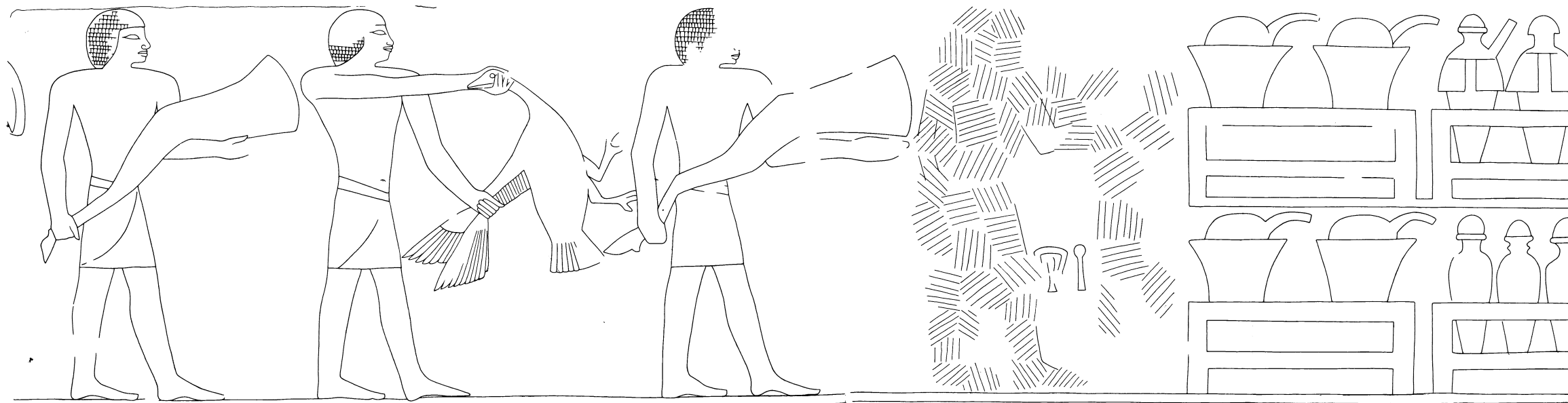

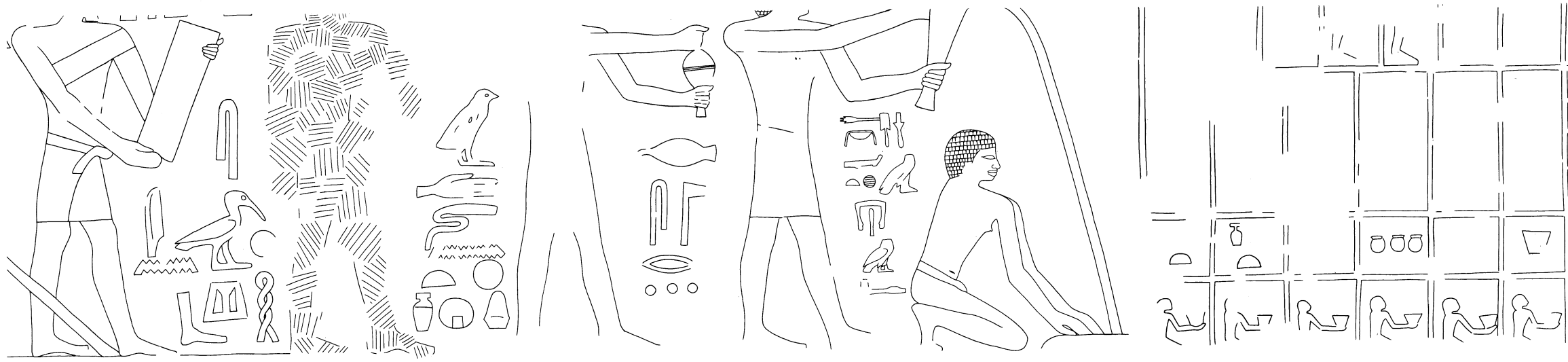

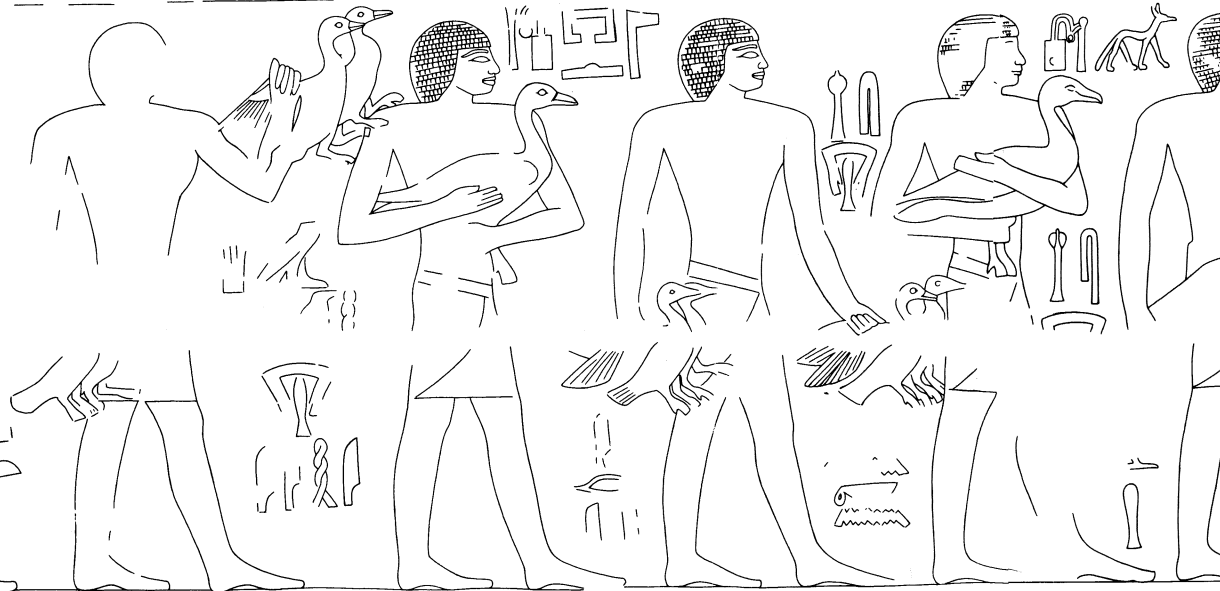
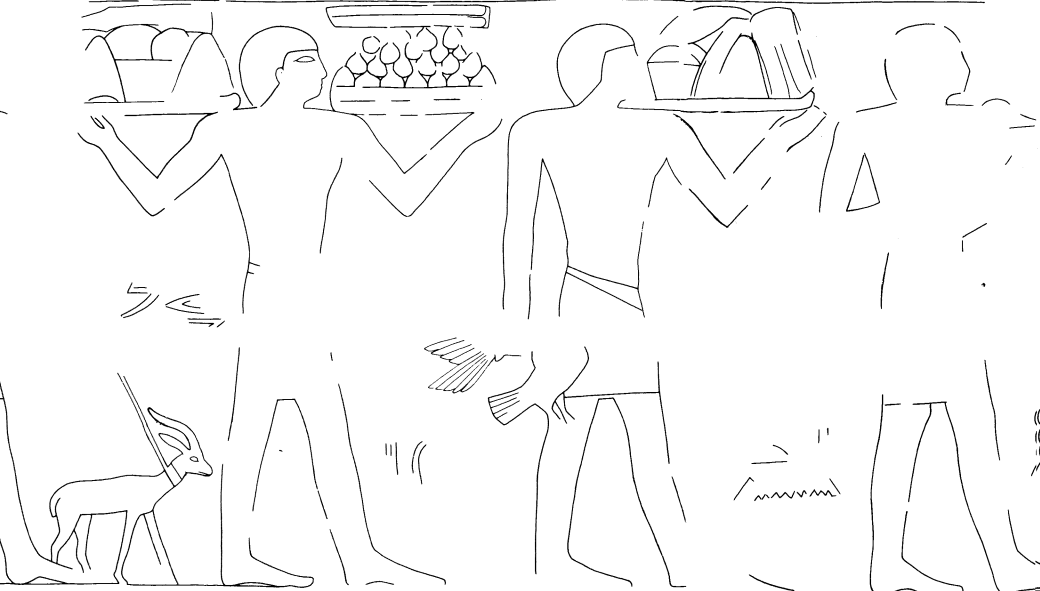
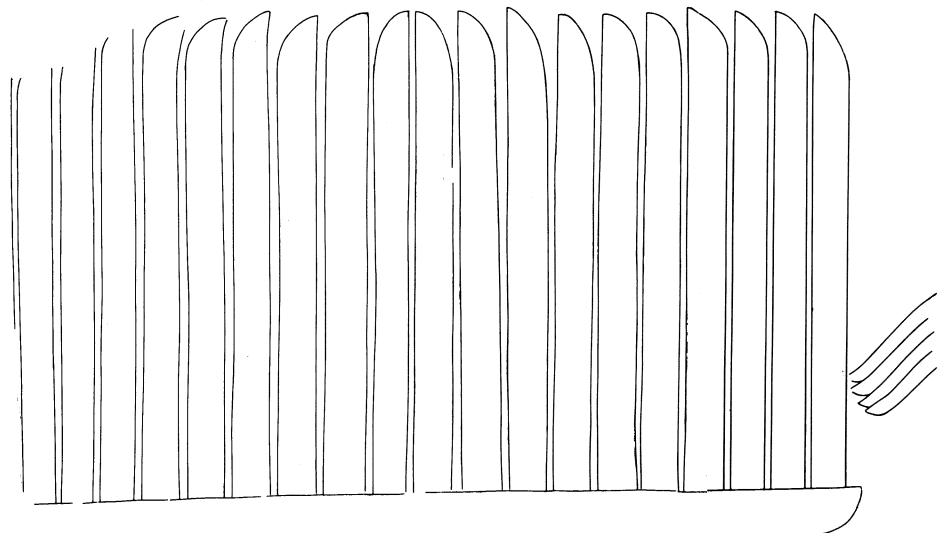
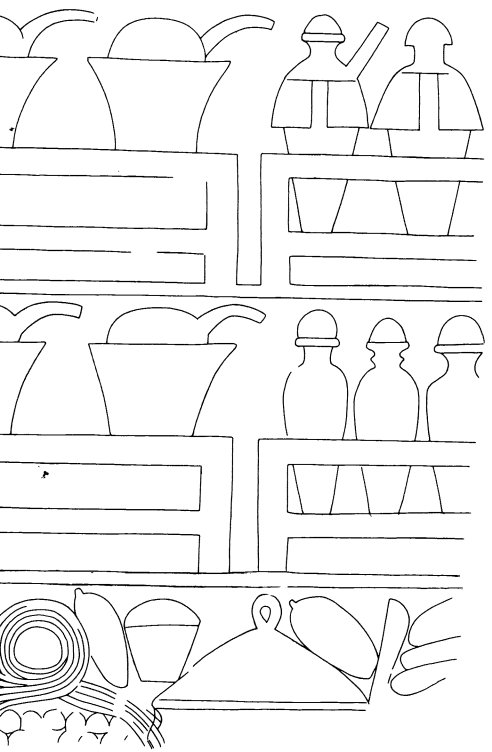
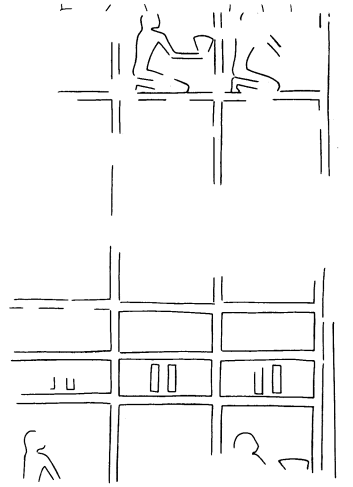
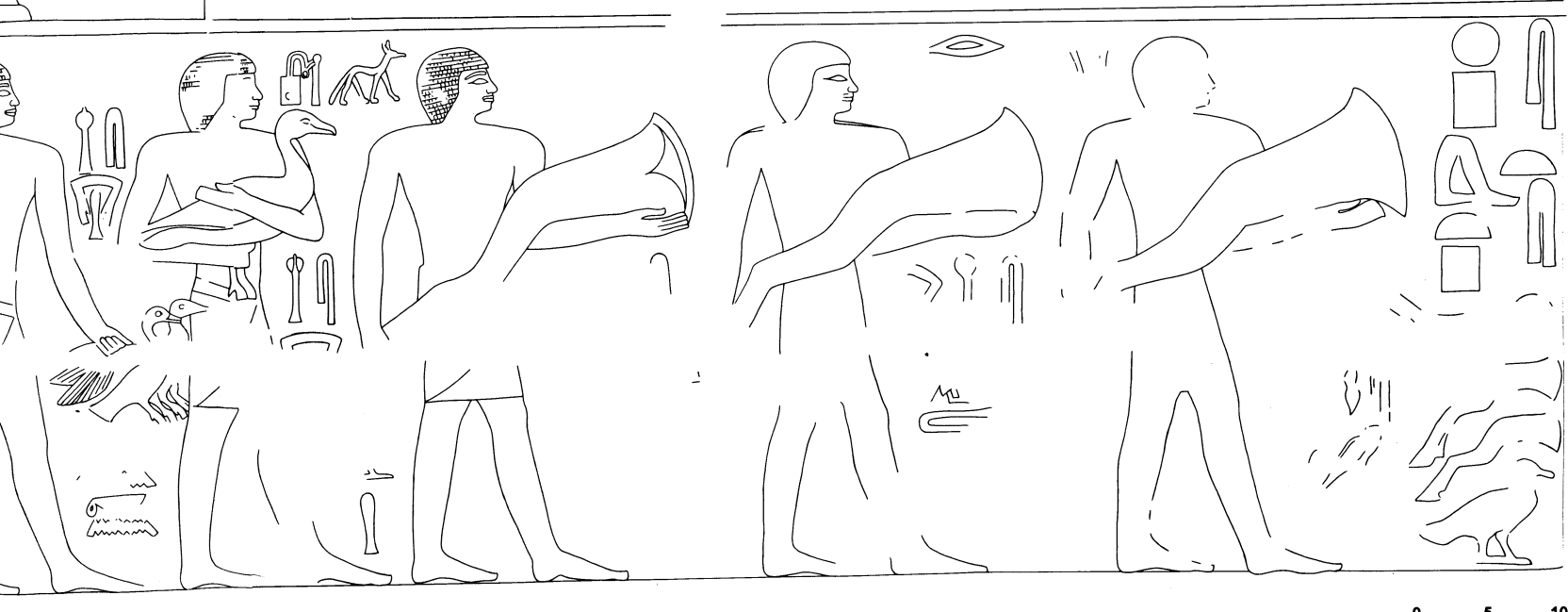
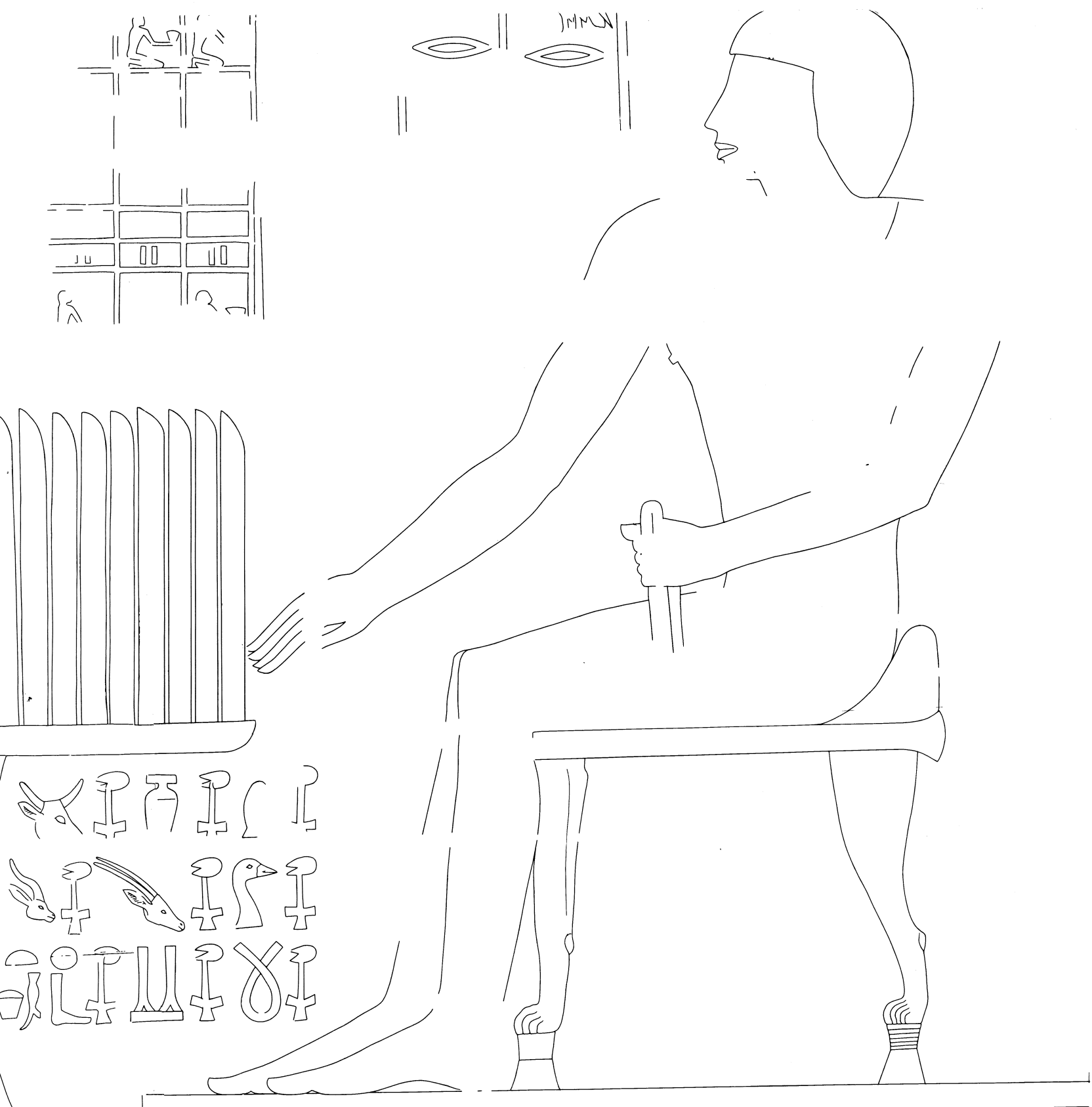

0 5 10 cm
1:5



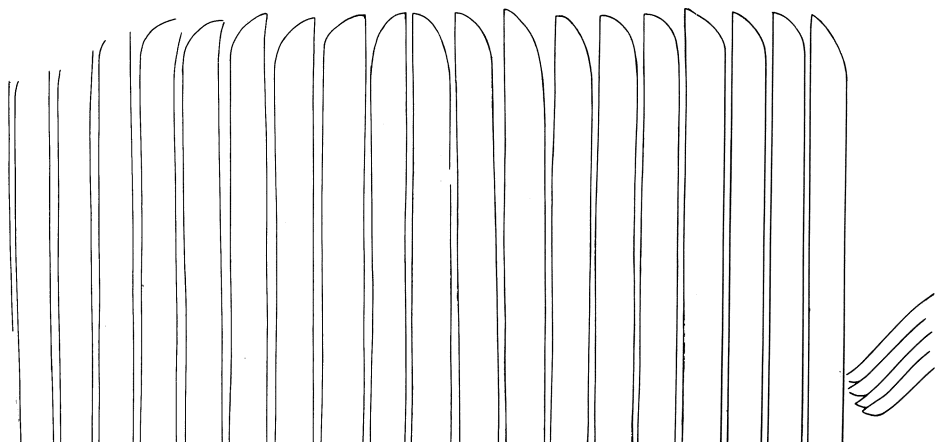
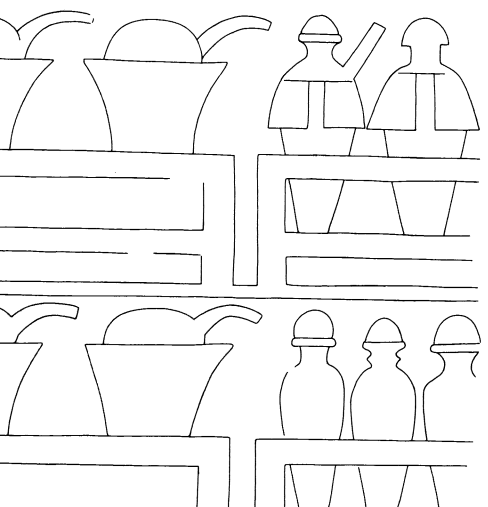
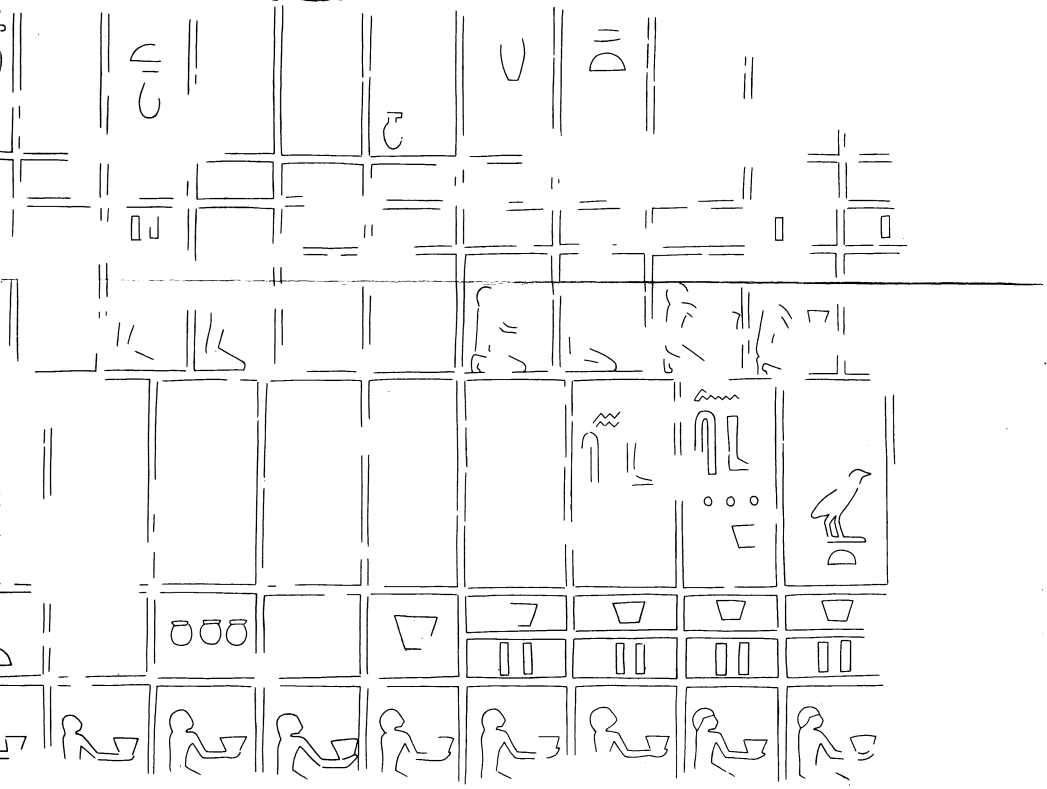
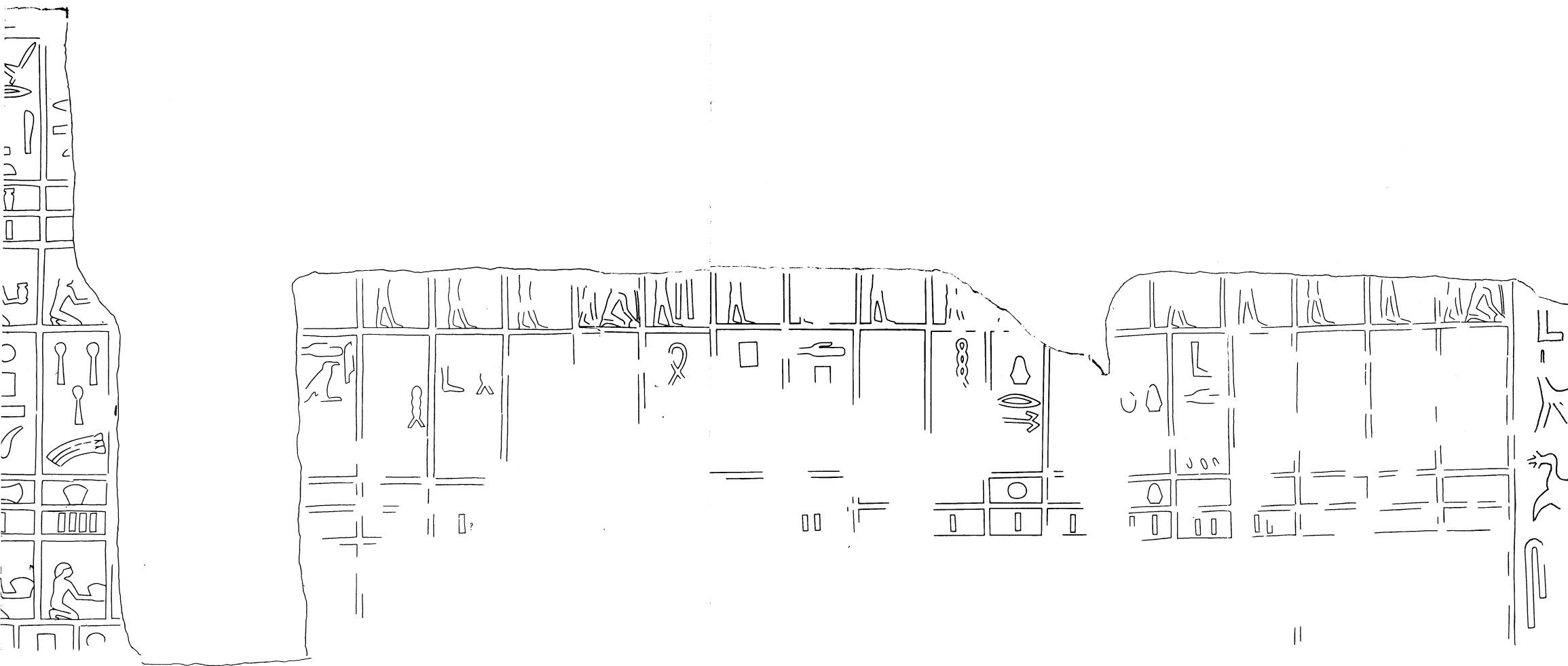

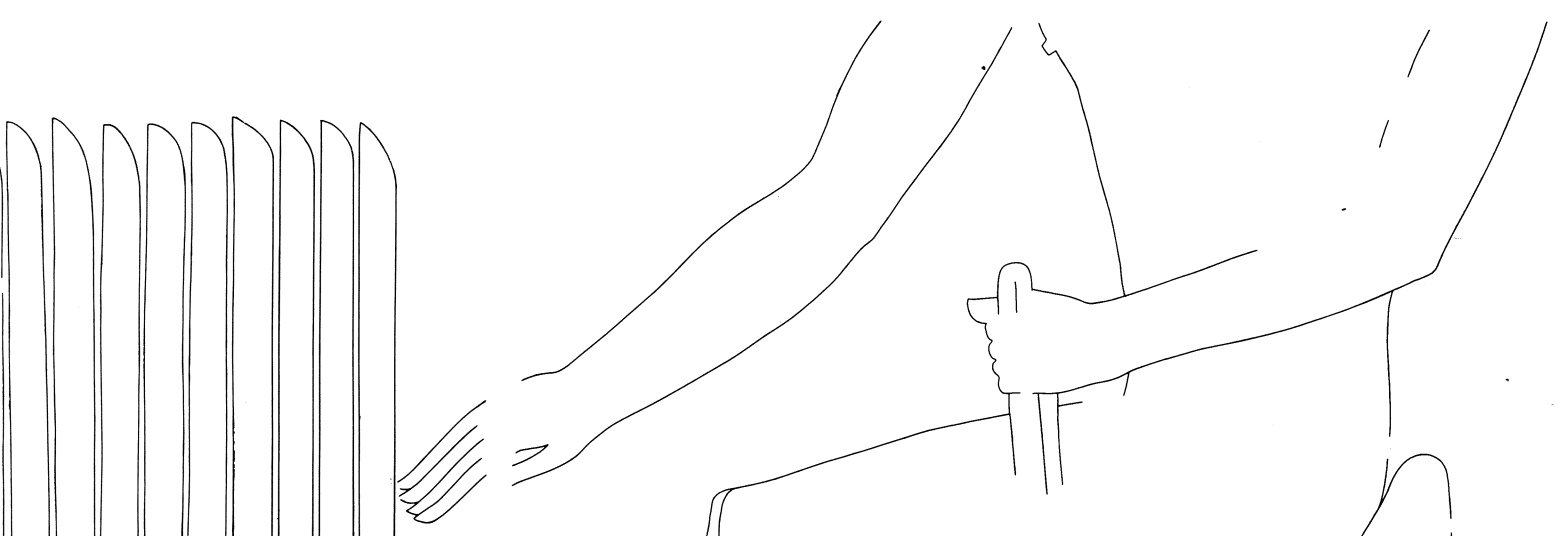
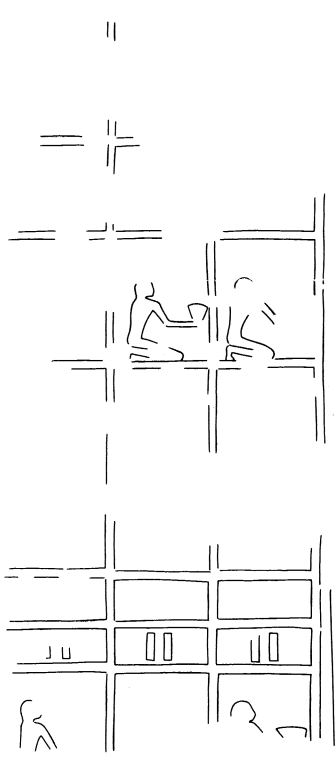
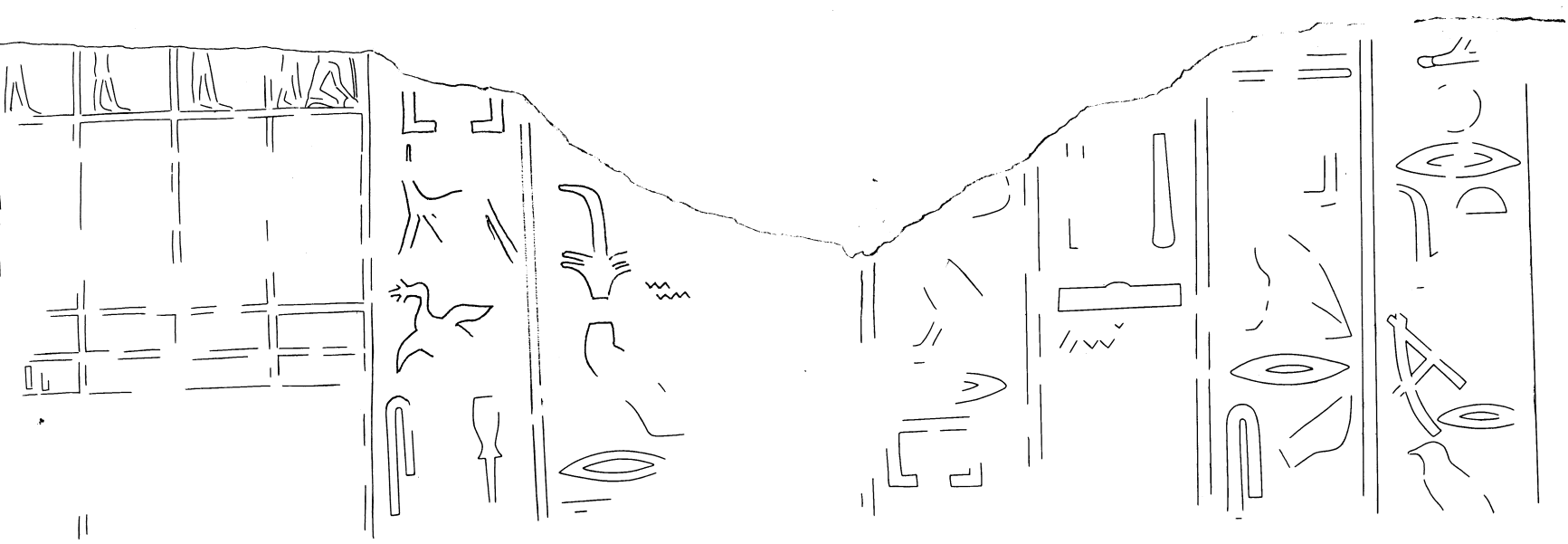

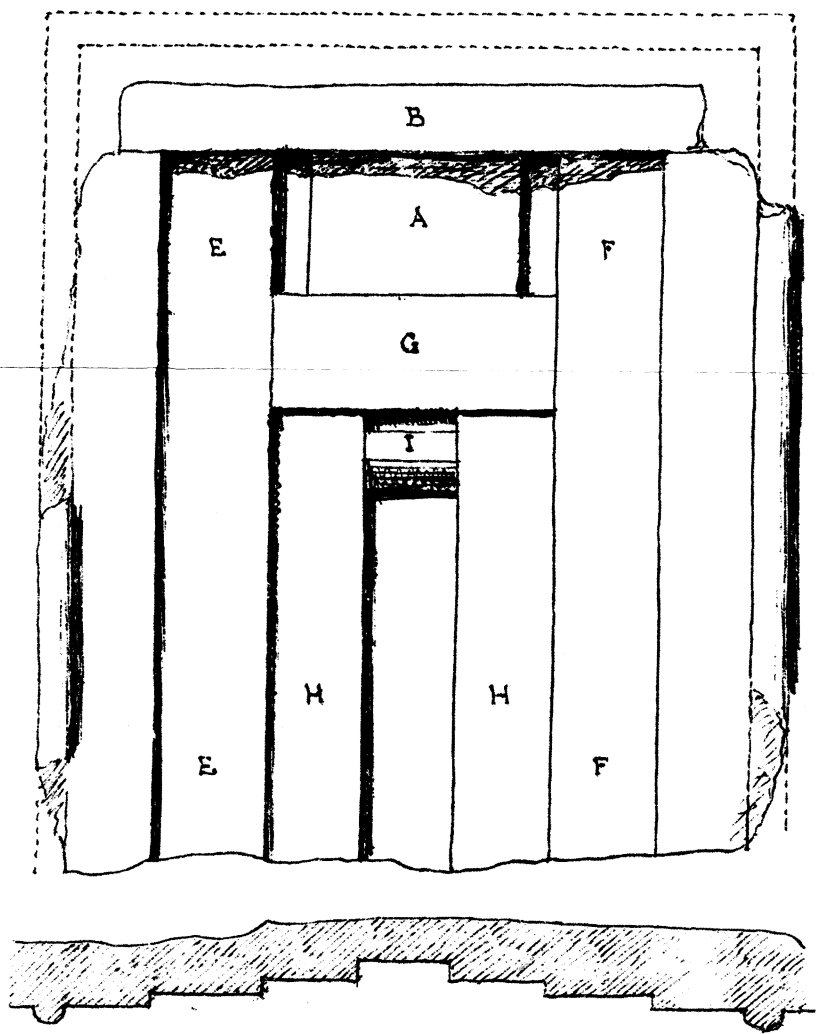

62a. Senedjemib Inti (G 2370), west wall, sketch of false door; Mariette, *Mastabas*, p. 505

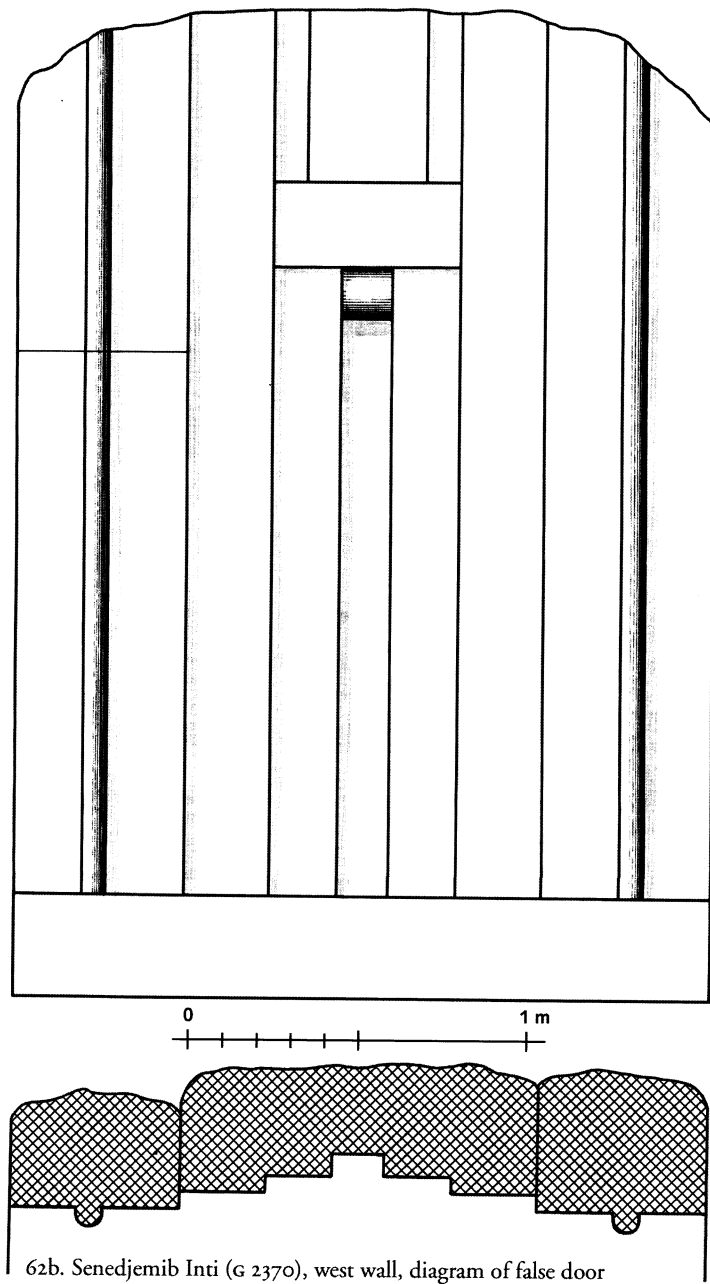

62b. Senedjemib Inti (G 2370), west wall, diagram of false door

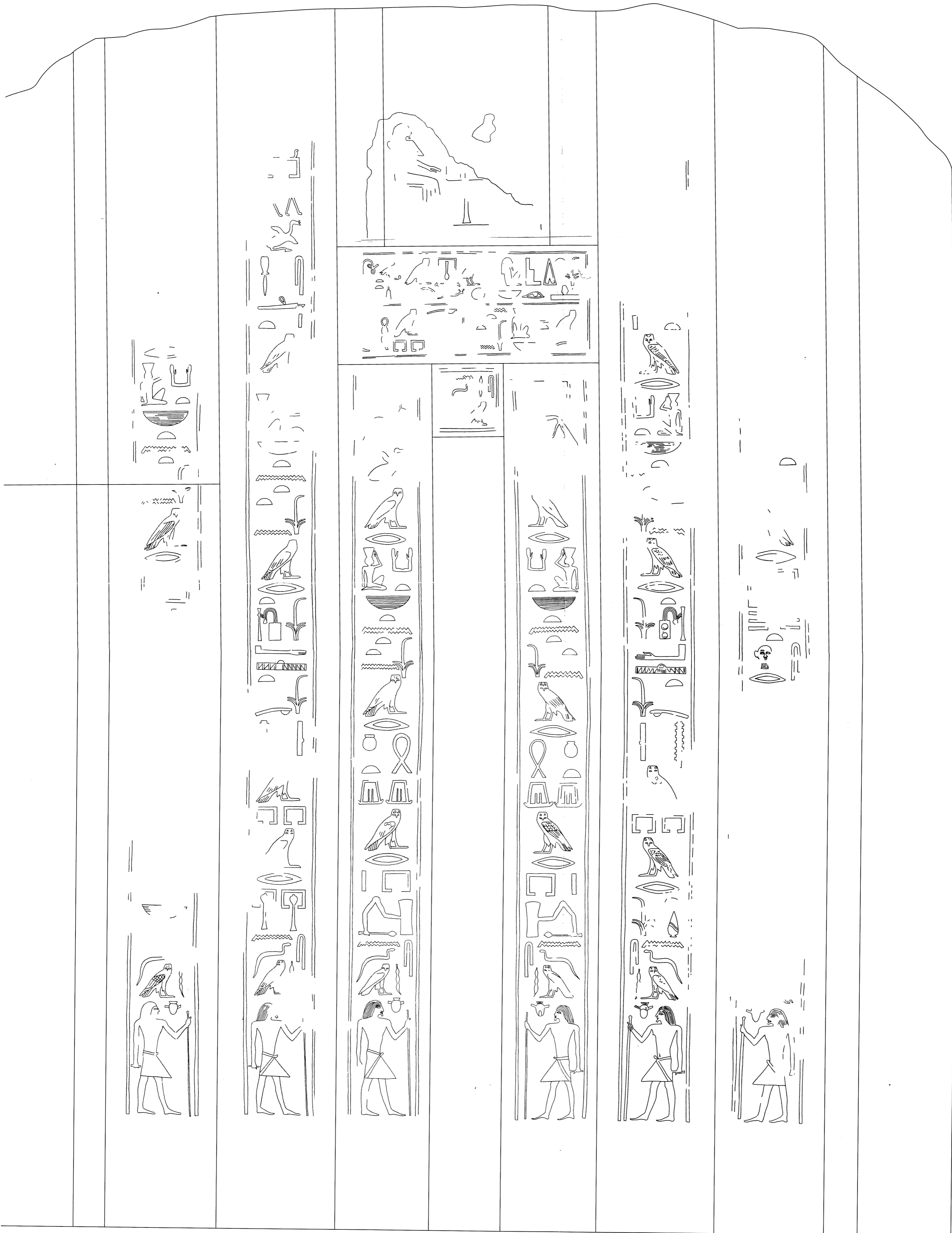

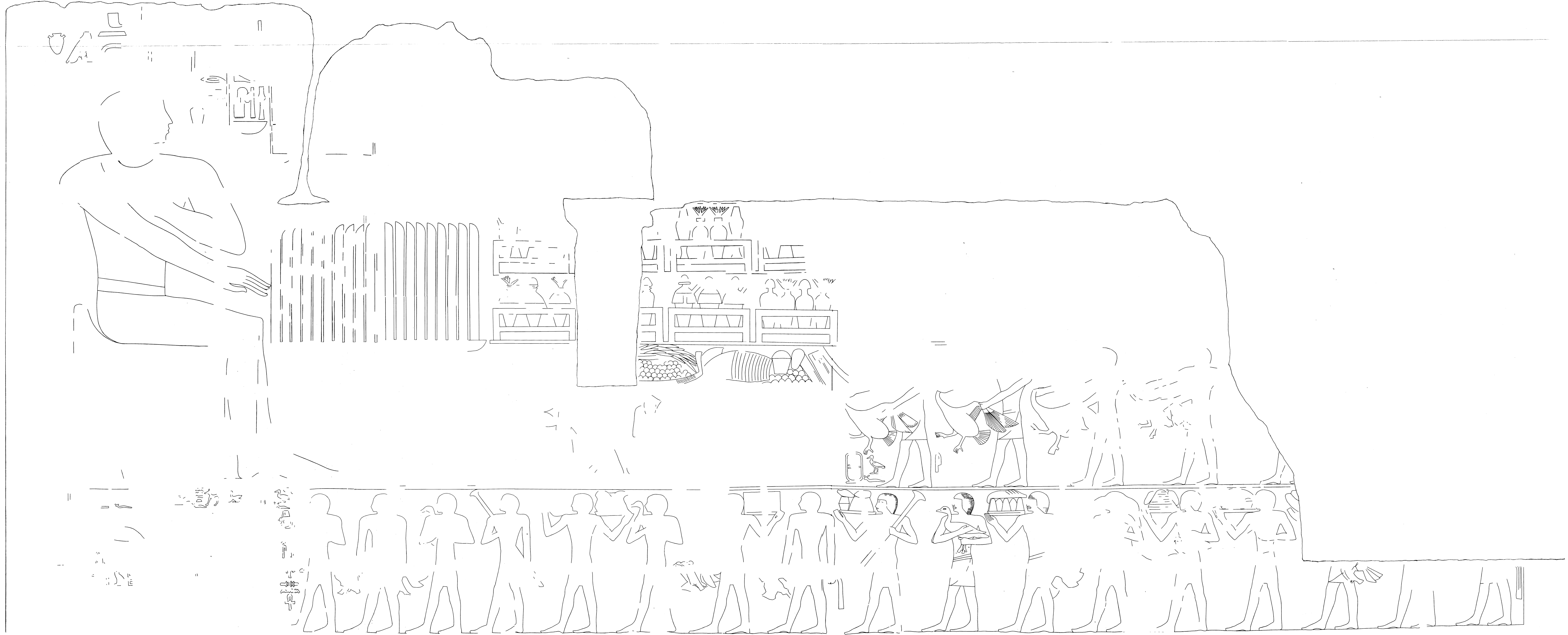

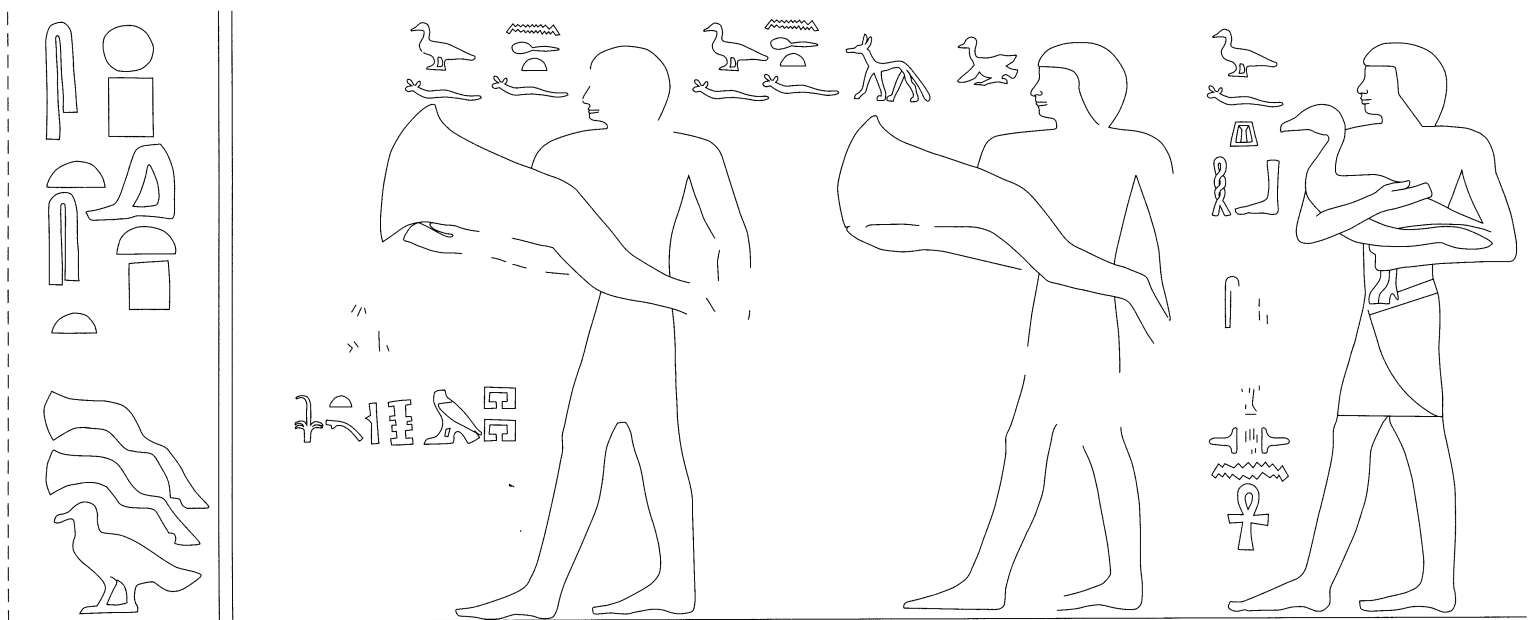

65. Senedjemib Inti (G 2370), proposed reconstruction of west end of north wall of Room IV, lowermost register

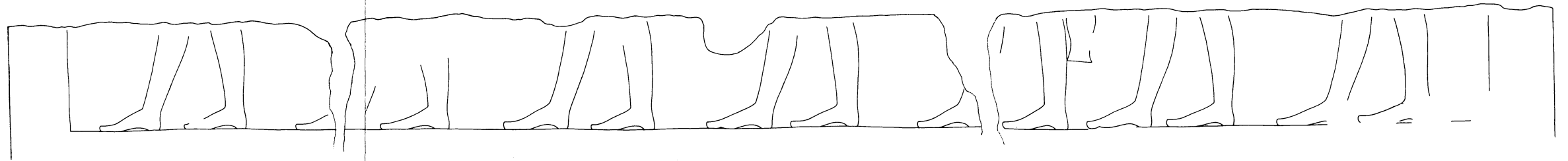

66. Senedjemib Inti (G 2370), Room IV, north wall, east of entrance. EG 4394

0 5 10 cm
+ + + + + 1:5



67a. Senedjemib Inti (G 2370), Room V, left (west) entrance thickness; LD 2, pl. 78a

1 Fuss Rhni

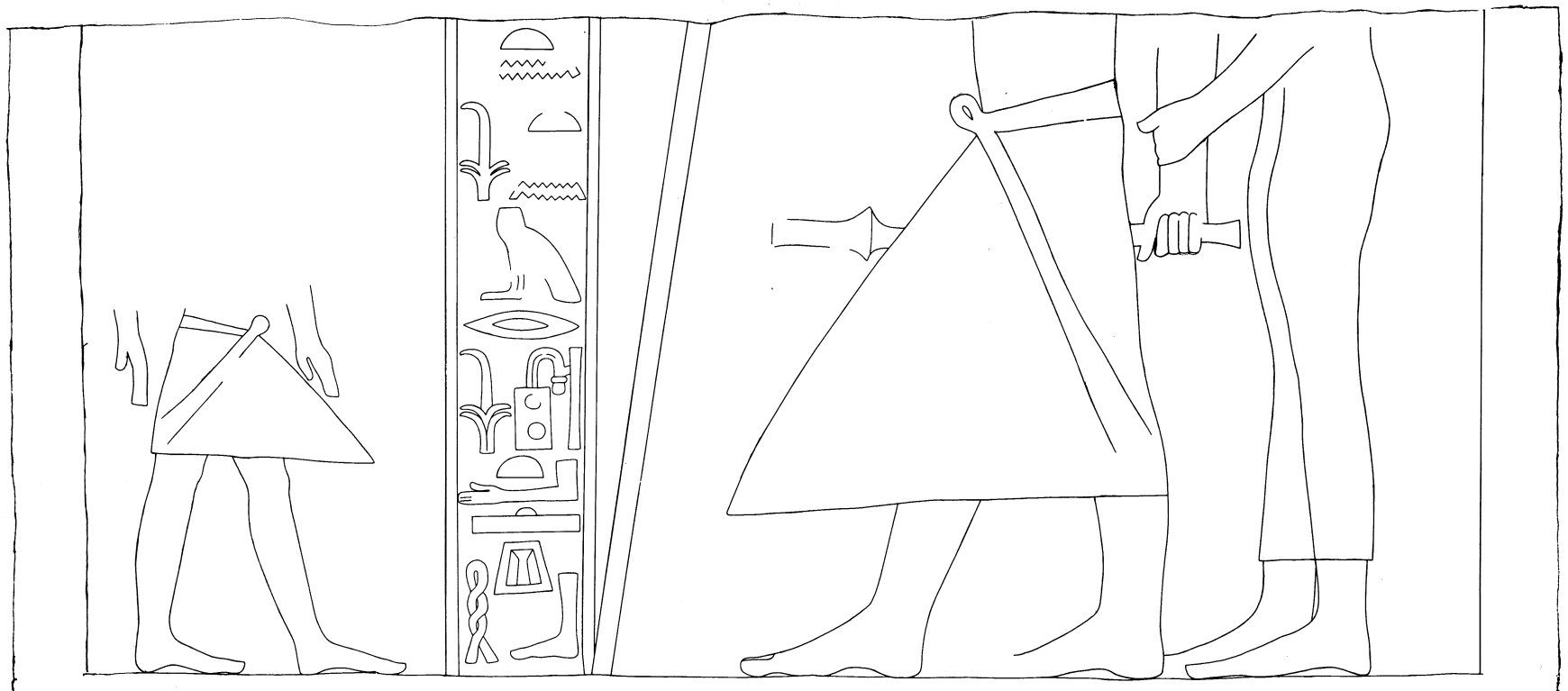

67b. Senedjemib Inti (G 2370), Room V, left (west) entrance thickness. EG 4426

0 5 10 cm
+++++ 1:5

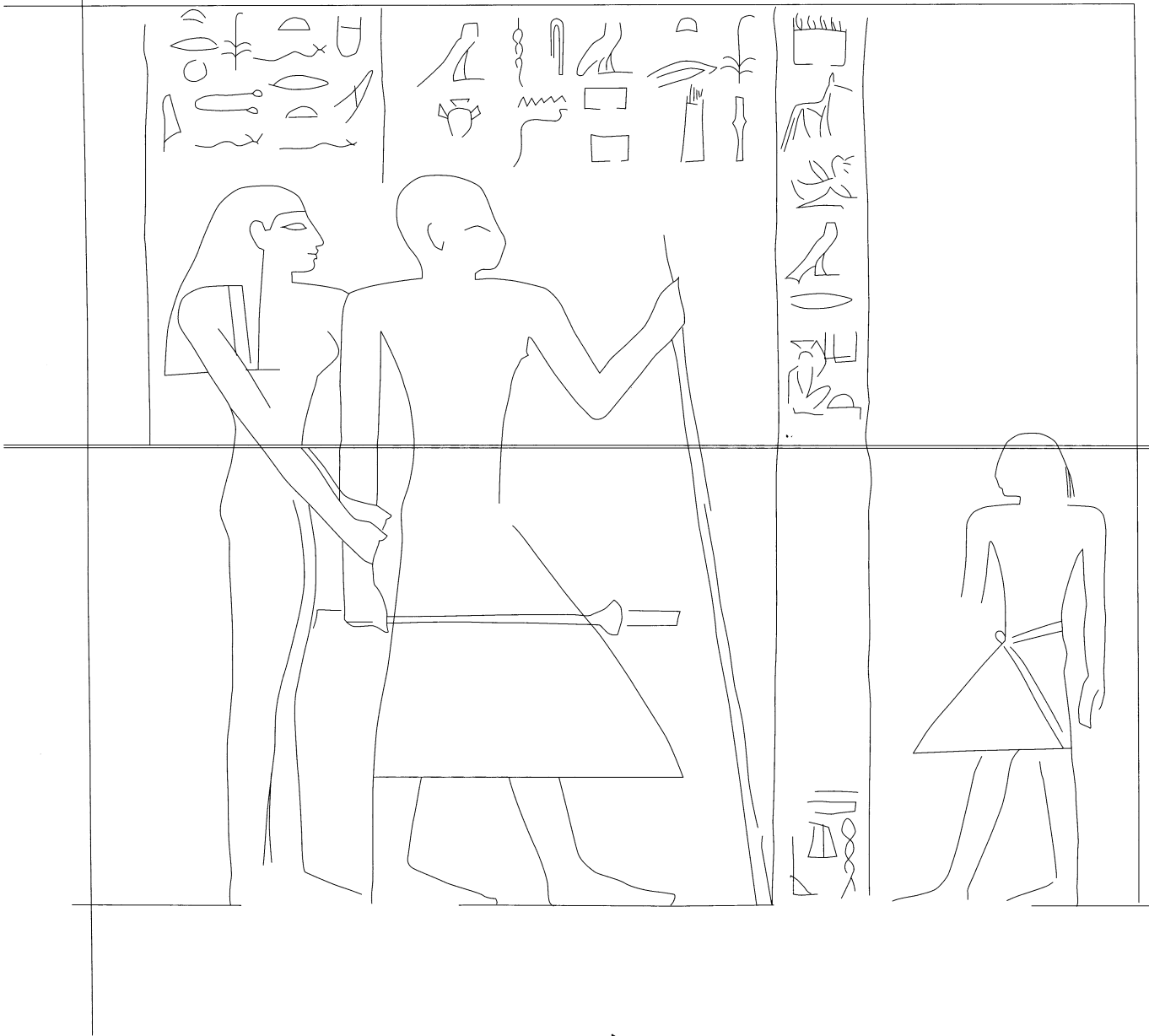

68a. Senedjemib Inti (G 2370), Room IV, right (east) entrance thickness. Redrawn from Lepsius Zeichnung Inv.-Nr. 348. Courtesy of the Archiv des Ägyptischen Wörterbuchs, Berlin-Brandenburgische Akademie der Wissenschaften

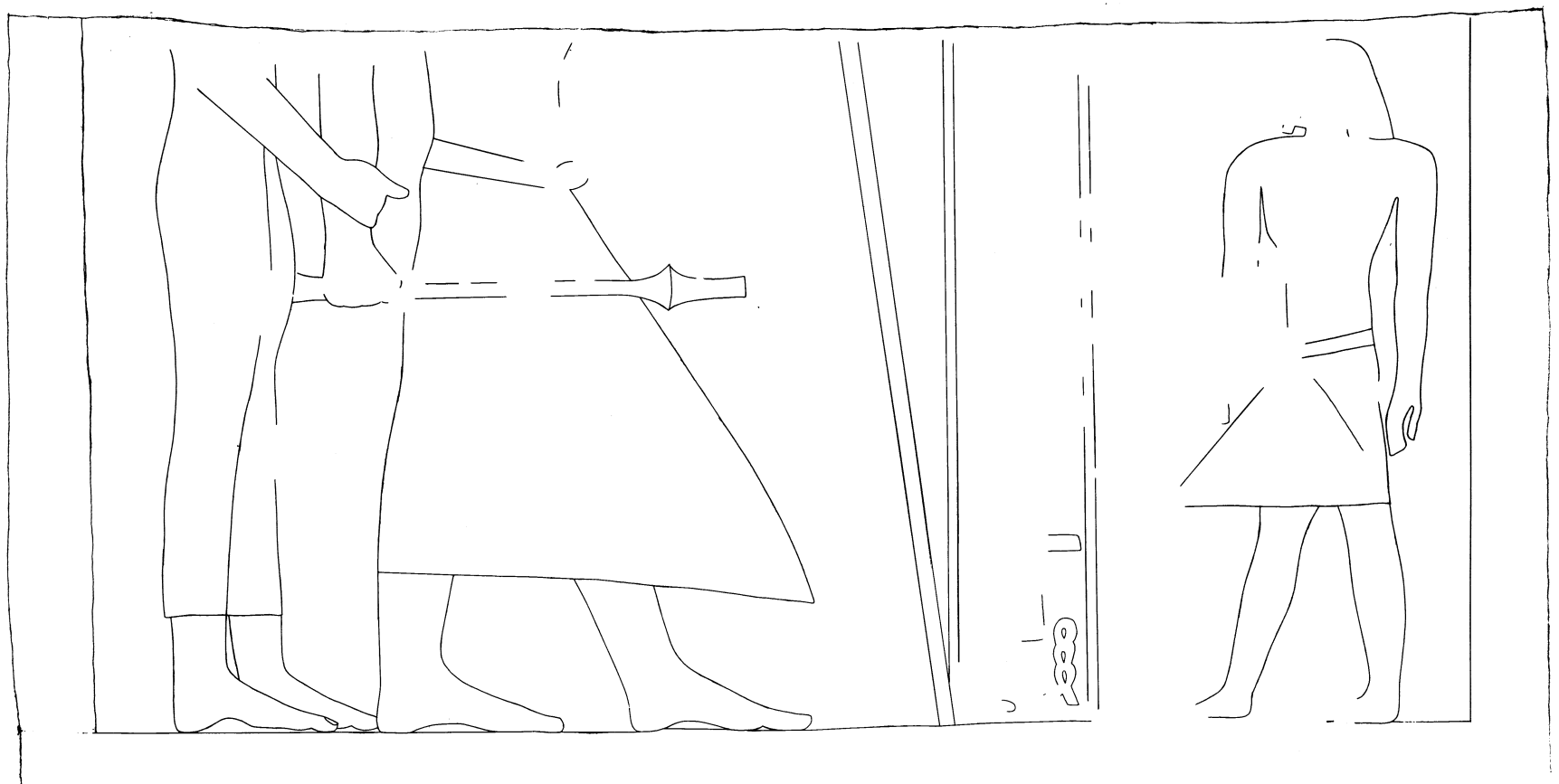

68b. Senedjemib Inti (G 2370), Room V, right (east) entrance thickness. EG 4426

0 5 10 cm
+++++ 1:5

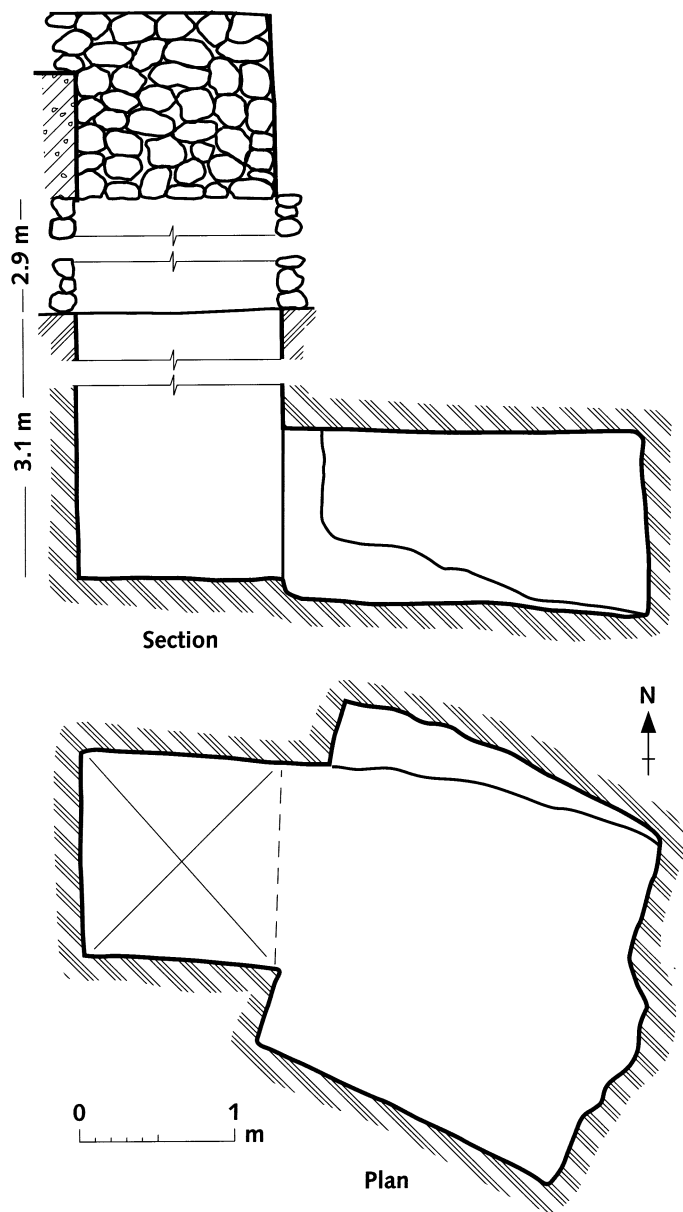

69a. Senedjemib Inti (G 2370), plan and section of shaft G 2370 A

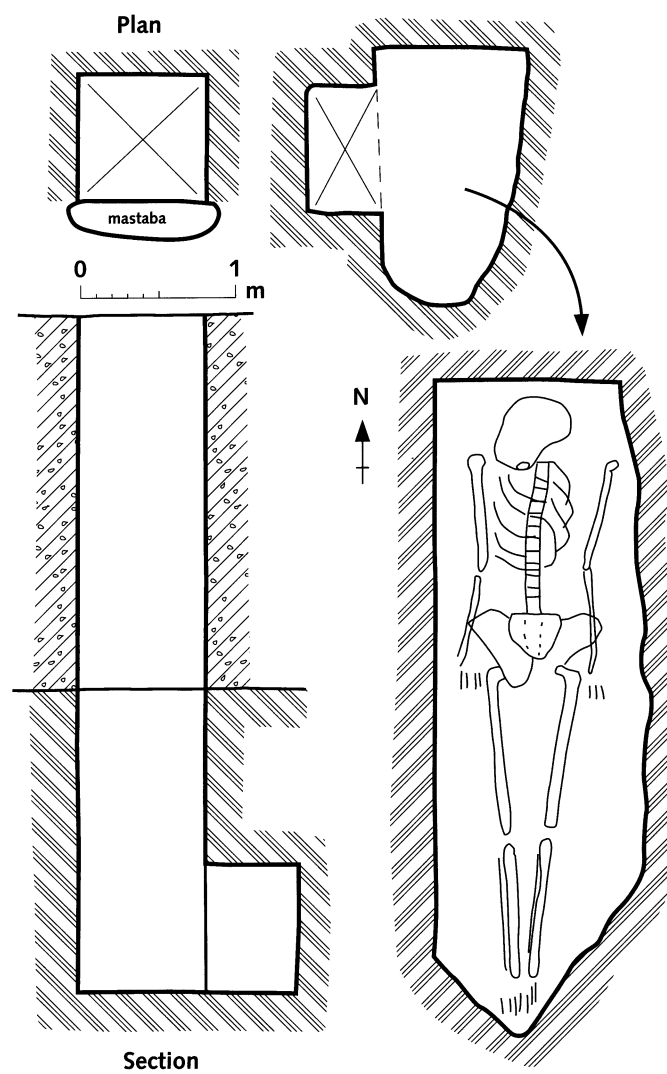

69b. Senedjemib Inti (G 2370), plan and section of intrusive shaft G 2370 X

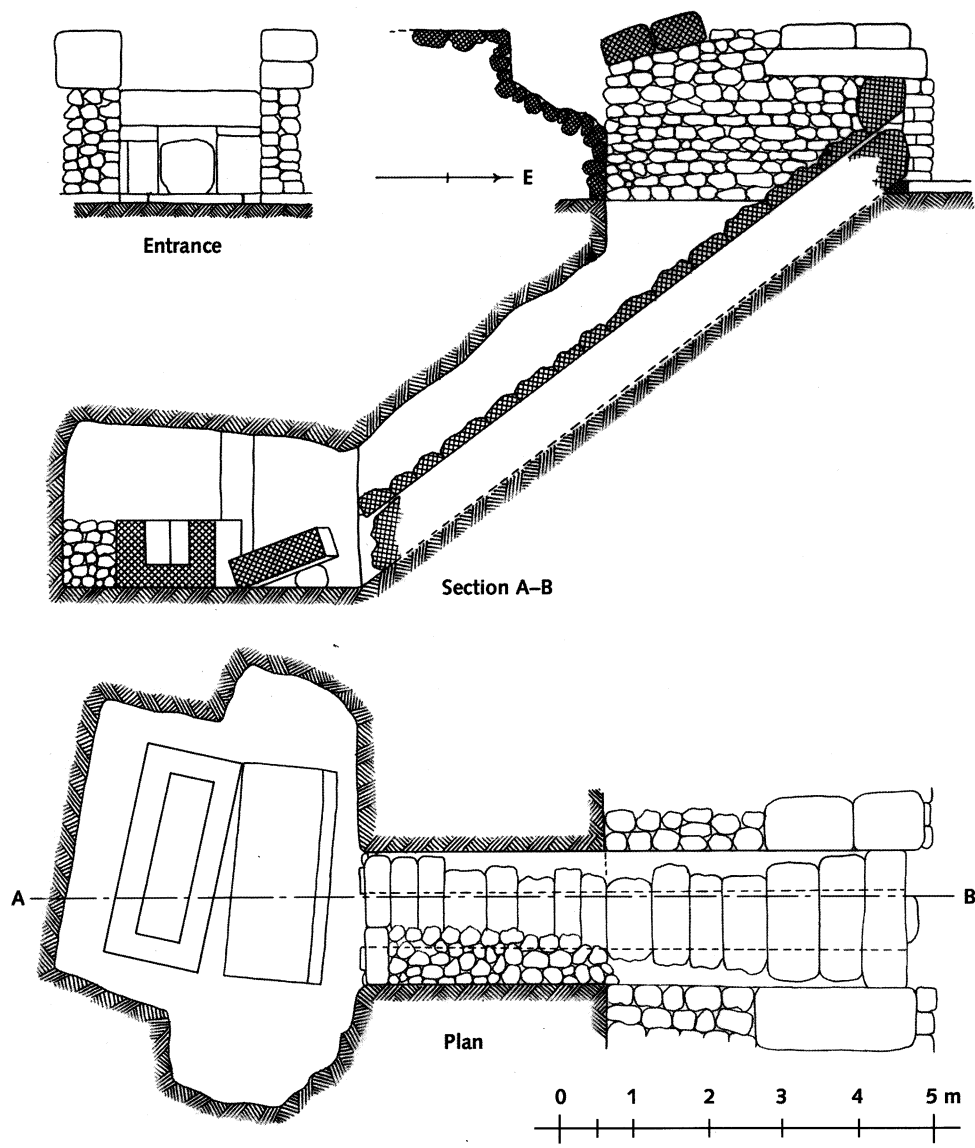

70. Senedjemib Inti (G 2370), plan and sections of sloping shaft tomb G 2370 B

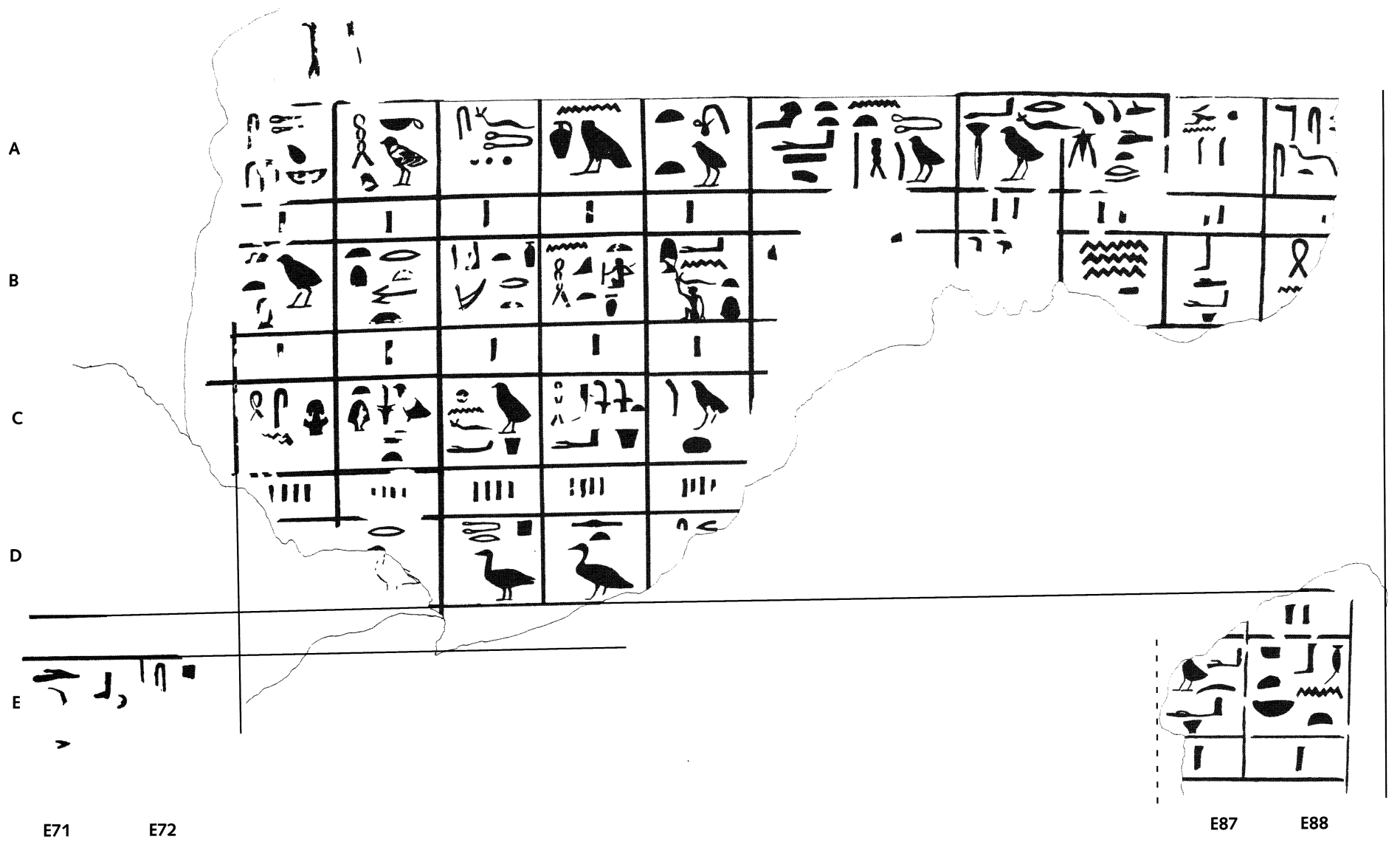

71. Senedjemib Inti (G 2370), sloping shaft tomb G 2370 B, offering list on east wall north of entrance. EG 850

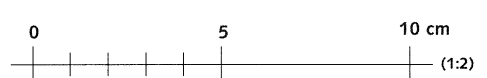
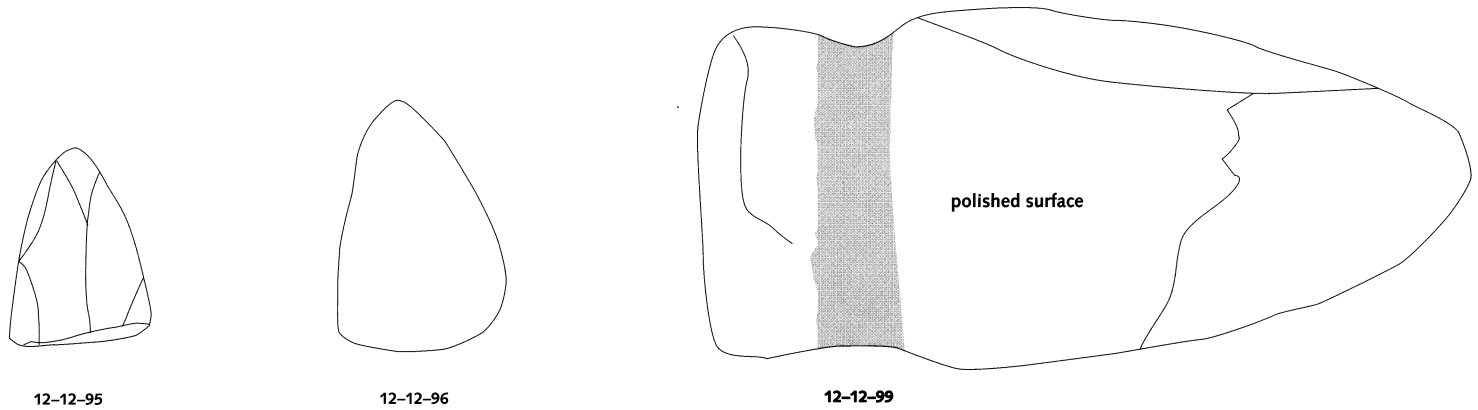
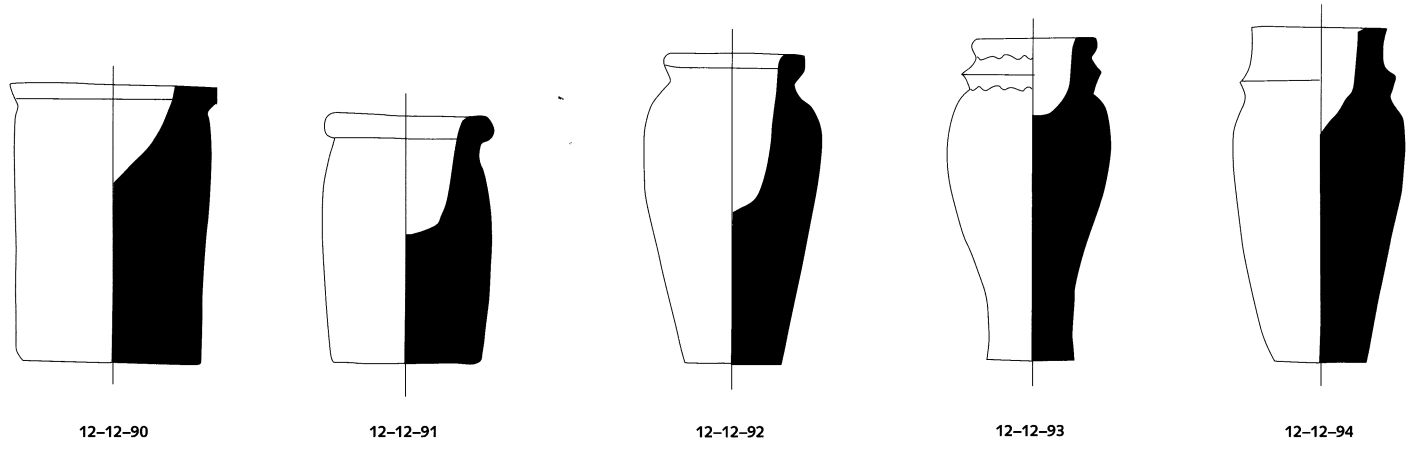
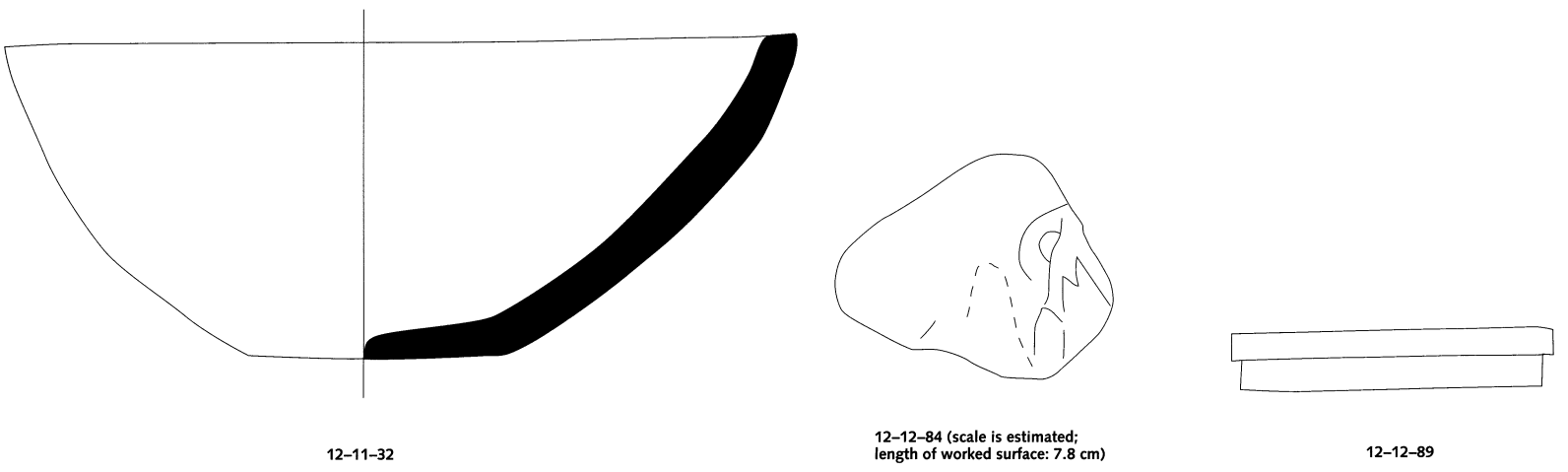
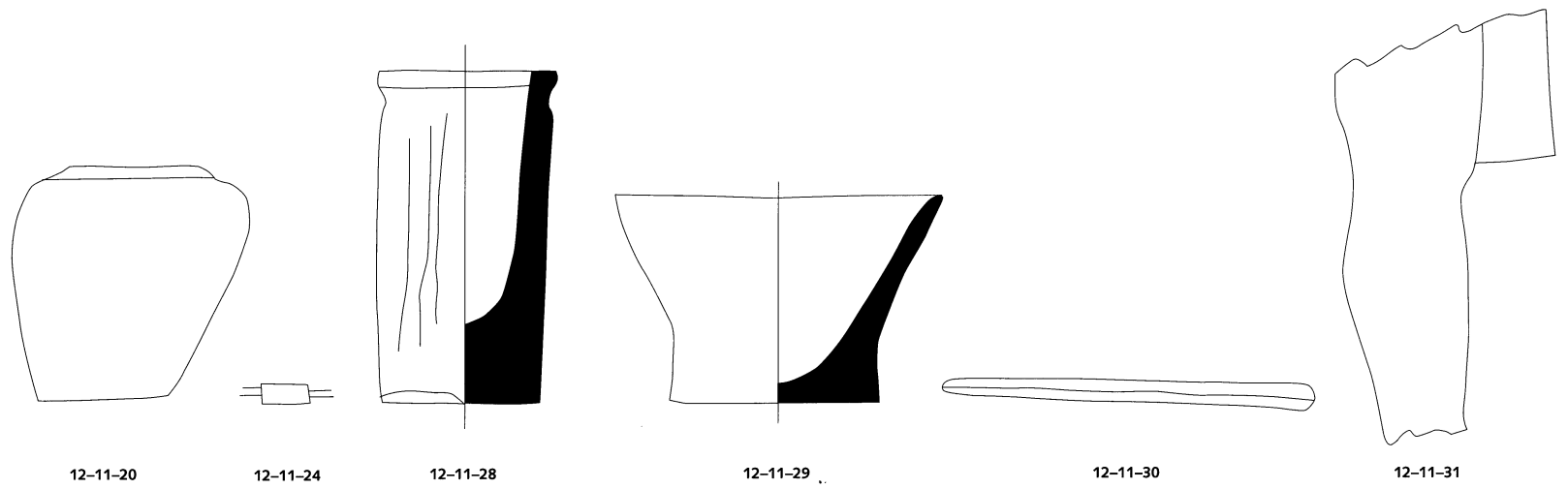

72. Senedjemib Inti (G 2370). Objects from G 2370, 2370 A, and 2370 B

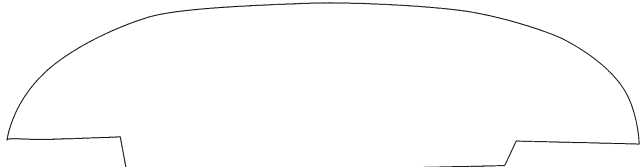

12-12-100

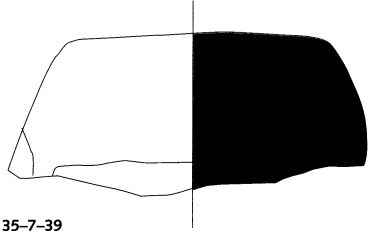

35-7-39

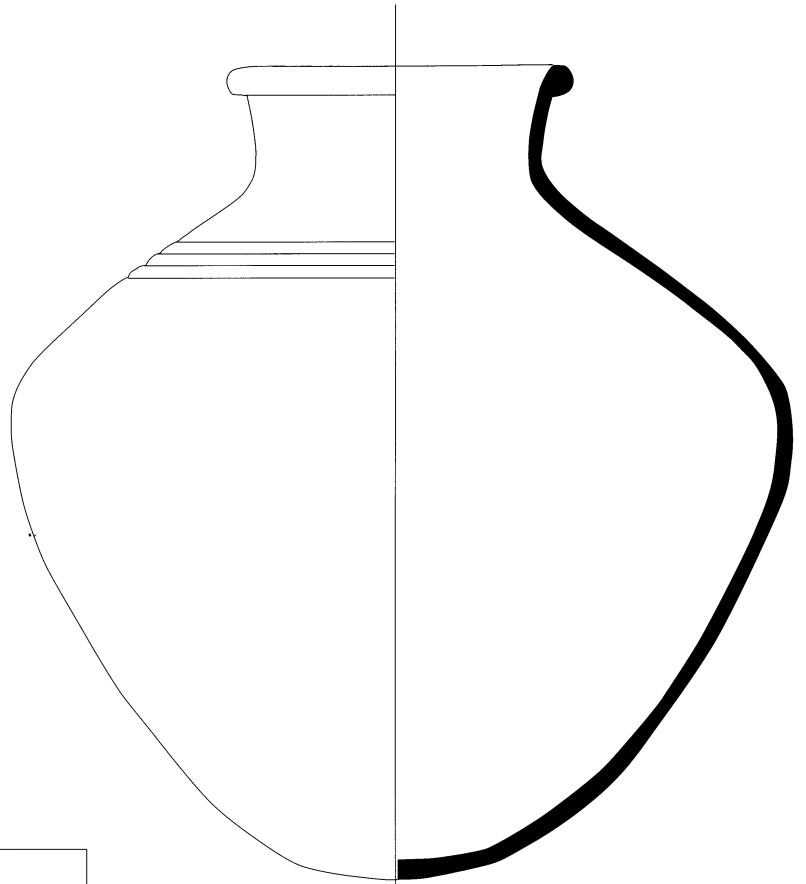
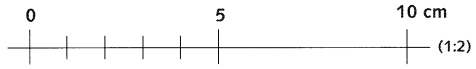

35-7-23

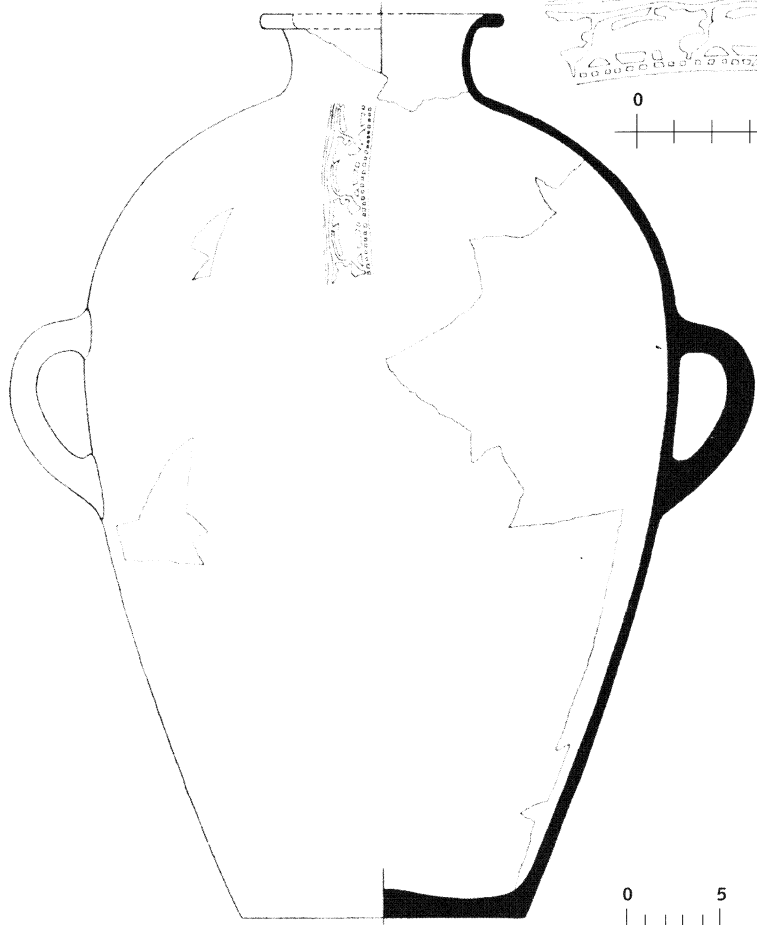

35-7-41

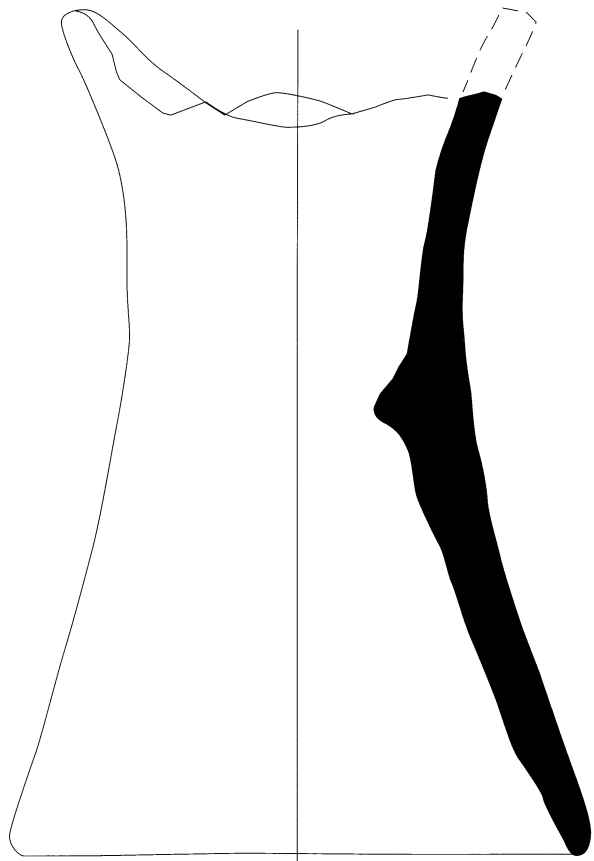
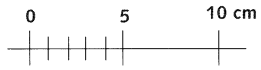

35-7-42

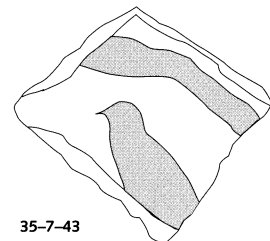

35-7-43

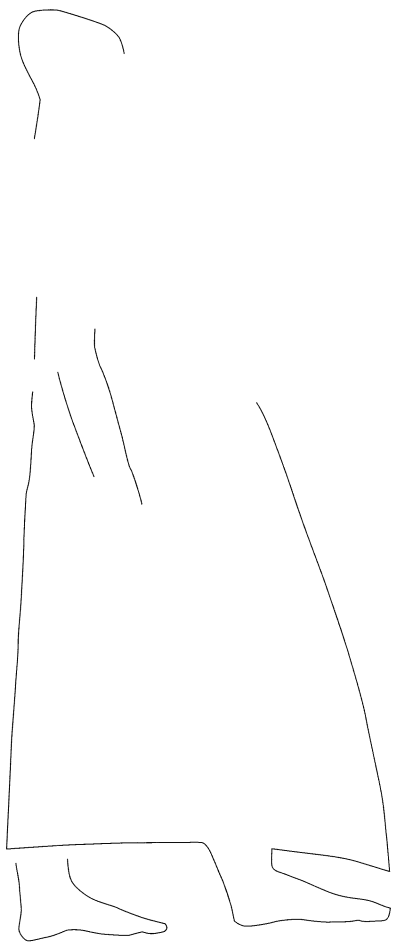

a

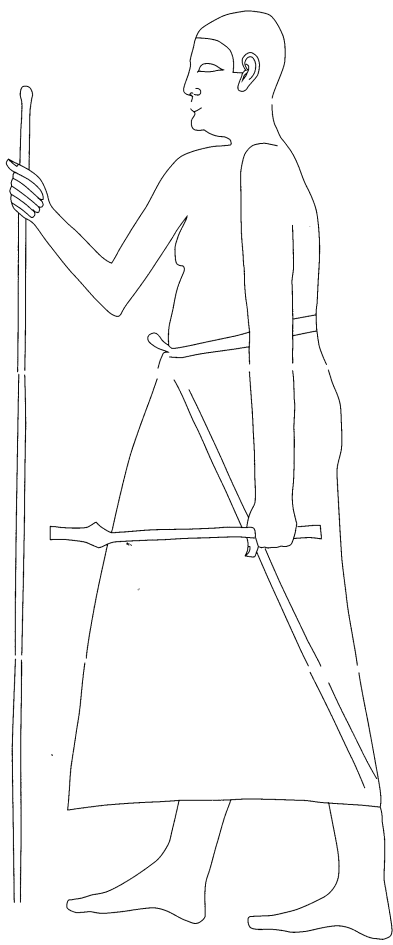

b

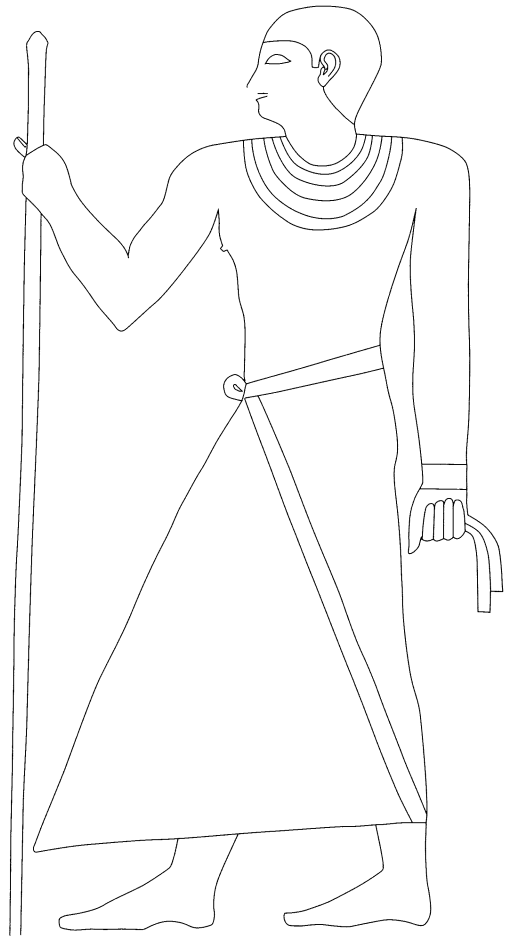

c

74. Long kilts from Old Kingdom tombs

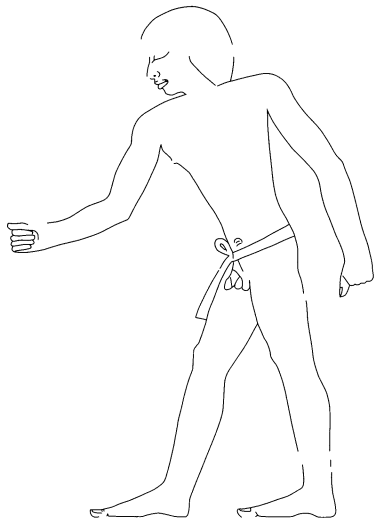

a

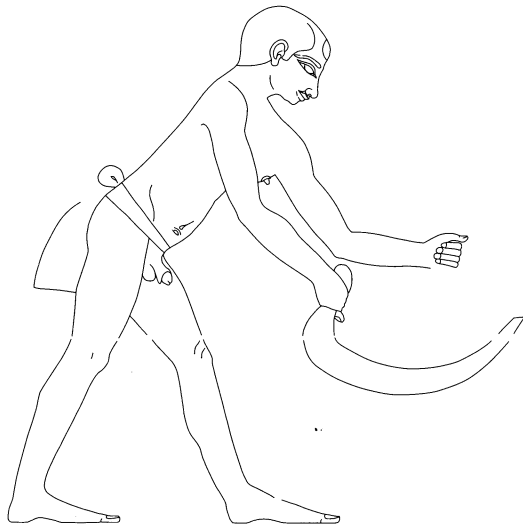

b

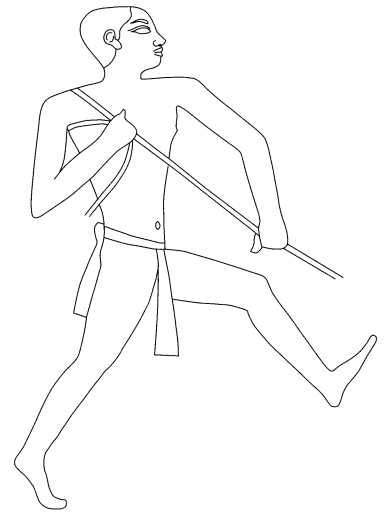

c



d

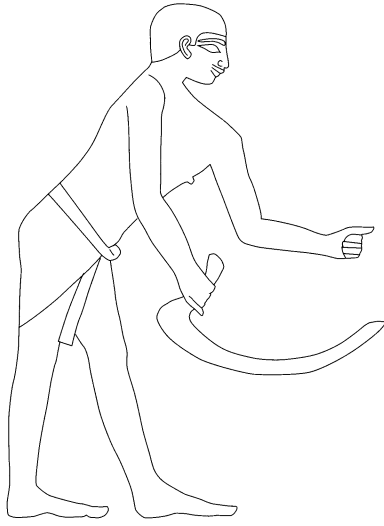

e

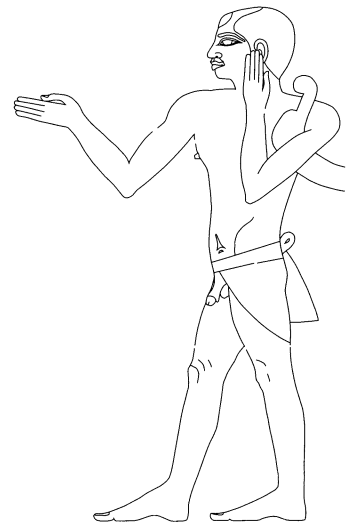

f

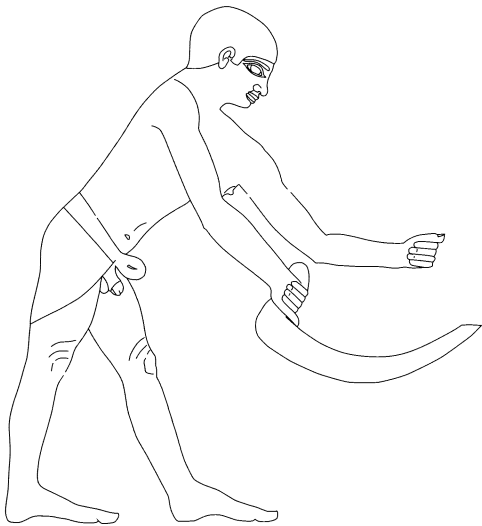

g

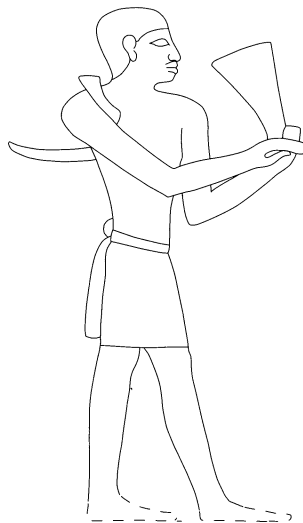

h

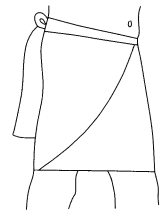

i

75. Clothing worn by laborers in scenes of daily life

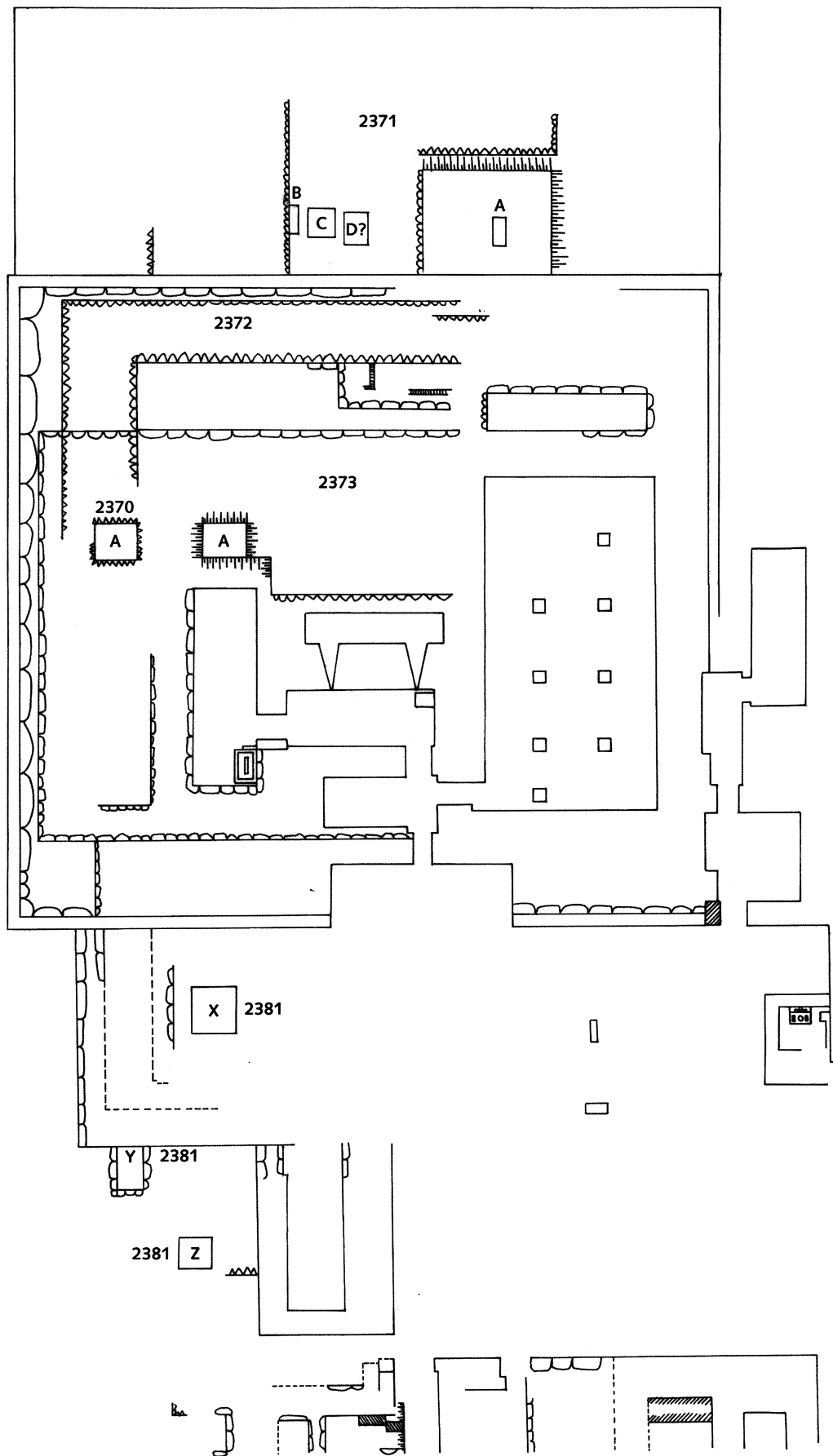

76. Schematic diagram of G 2370, 2371 A-D, 2372, 2373, 2381 X, Y, Z

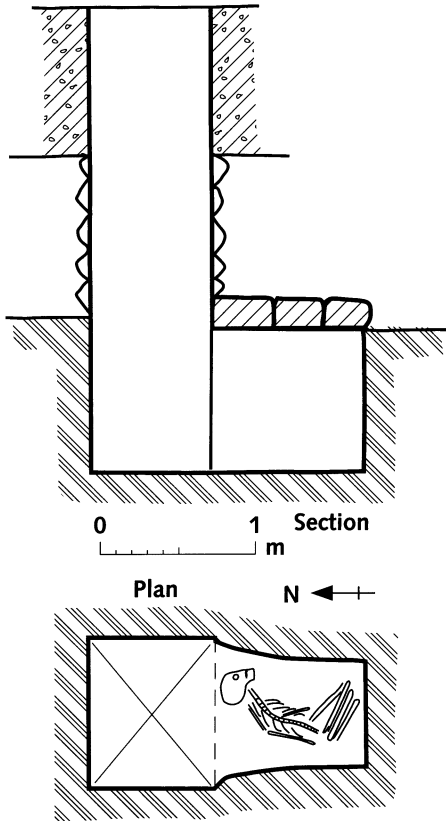

77a. Shaft G 2371 X

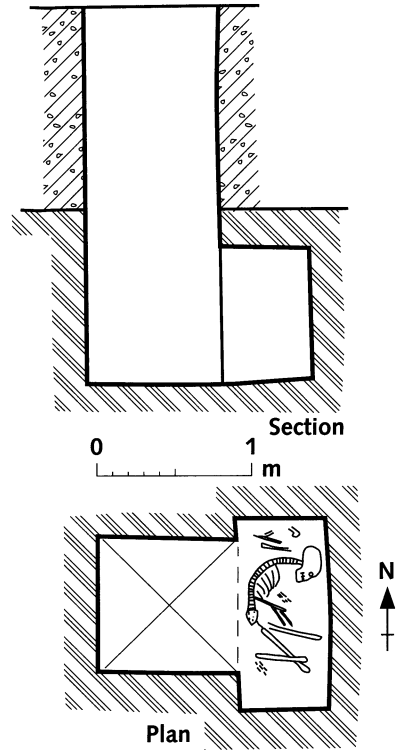

77b. Shaft G 2371 Y

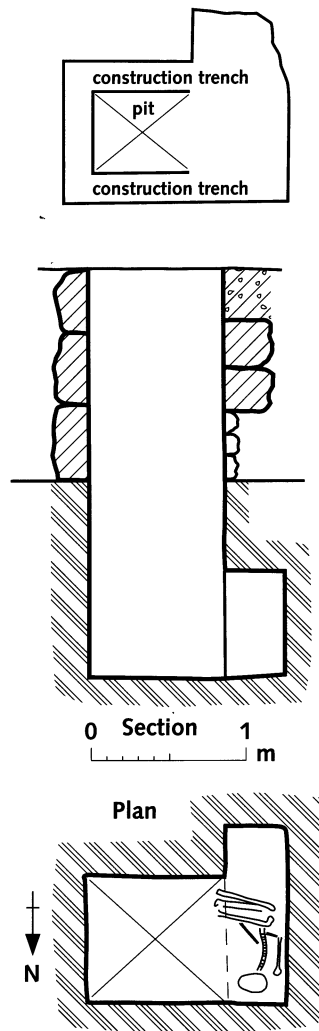

77c. Shaft G 2371 Z

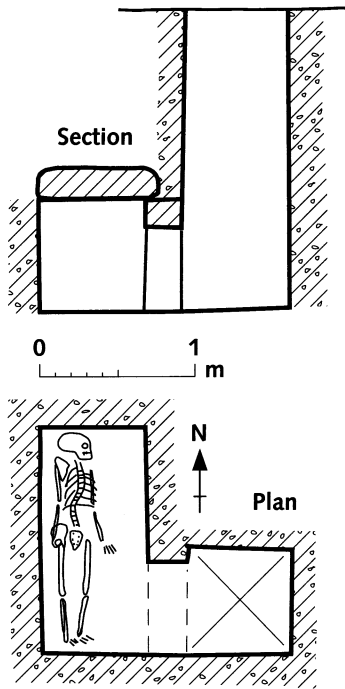

78a. Shaft G 2371 U

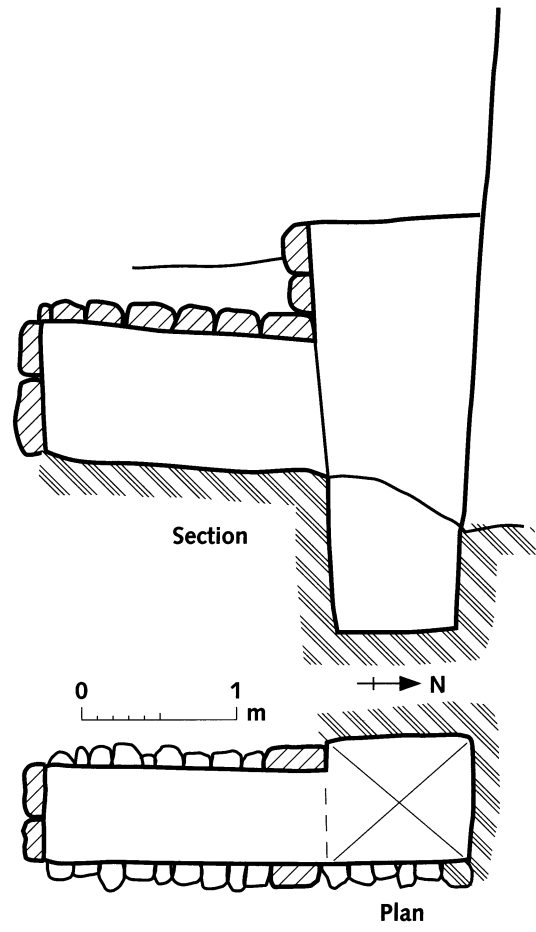

78b. Shaft G 2371 W

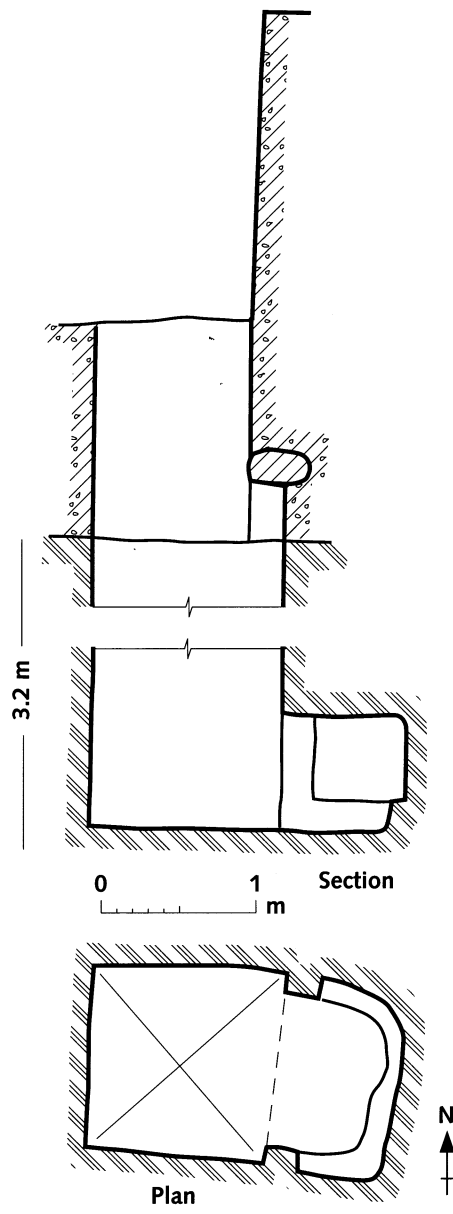

78c. Shaft G 2373 A

G 2371

G 2373

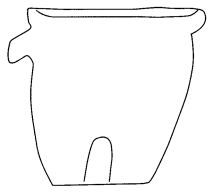

12-11-34

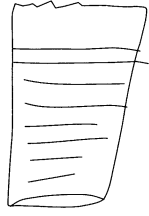

12-11-35

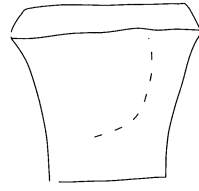

no number; no scale

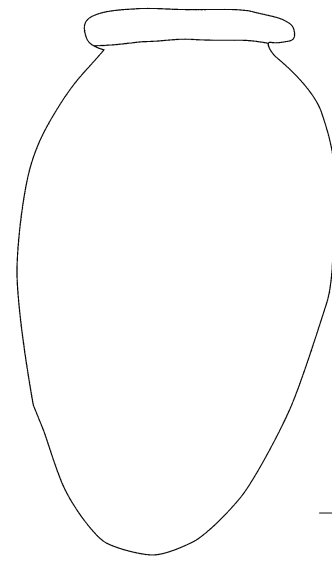
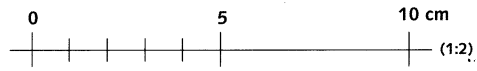

no number

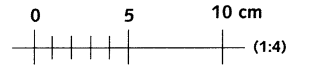

79a. Objects from G 2371, G 2373 (rough sketches after object register and diary)

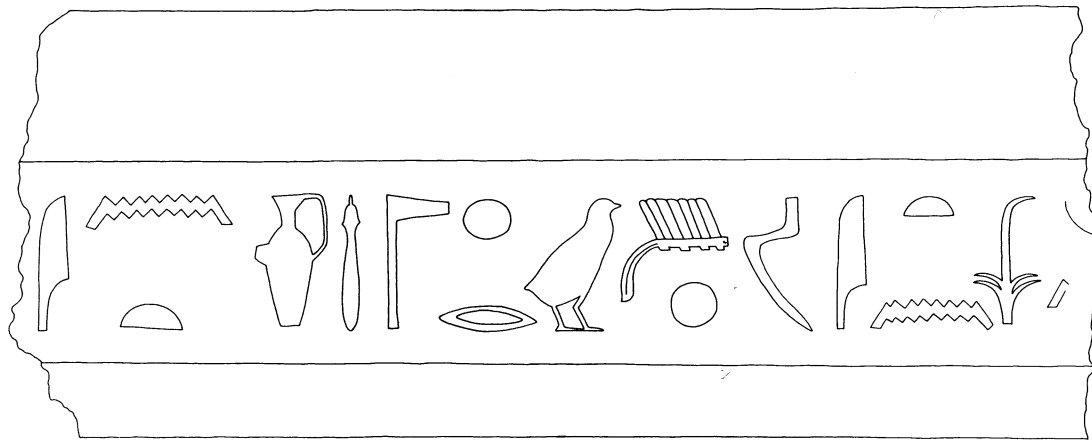

79b. Khnumenti (G 2374), architrave fragment

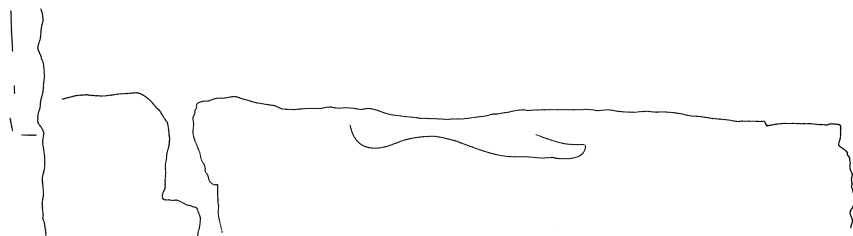
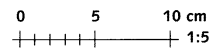

79c. Khnumenti (G 2374), facade south of entrance. EG 470I

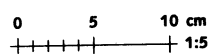



80. Khnumenti (G 2374), facade north of entrance. EG 4366, 4523

