

81a. Khnumenti (G 2374), Room I, left (south) entrance thickness. EG 4701

0 5 10 cm
+++++ 1:5

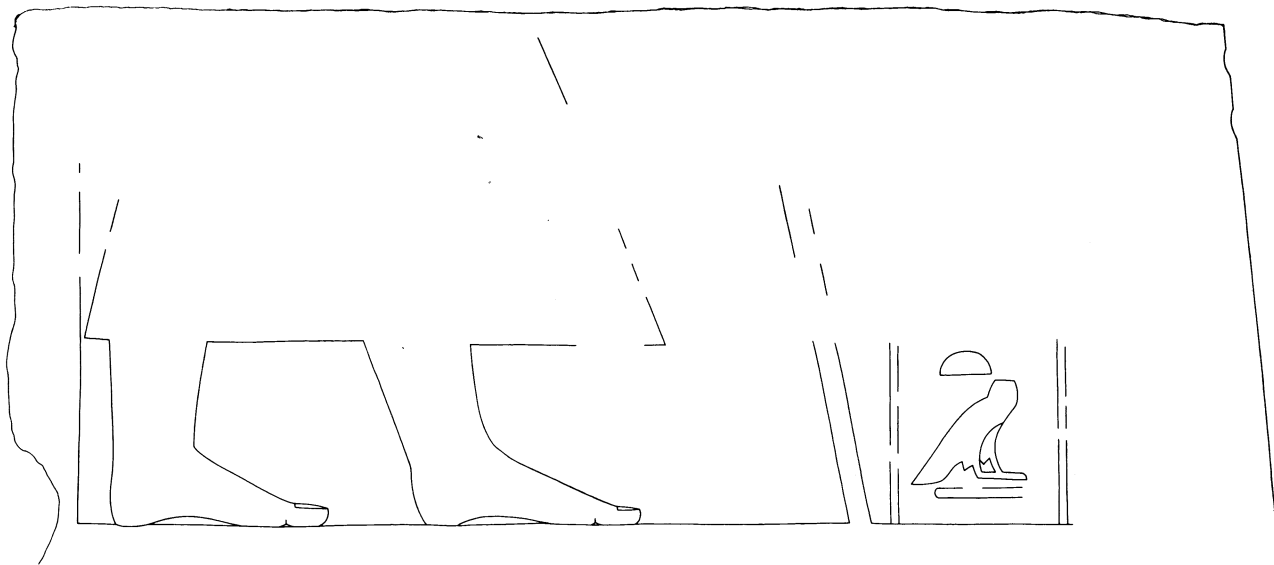

81b. Khnumenti (G 2374), Room I, right (north) entrance thickness. EG 4368

0 5 10 cm
+++++ 1:5

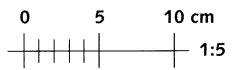
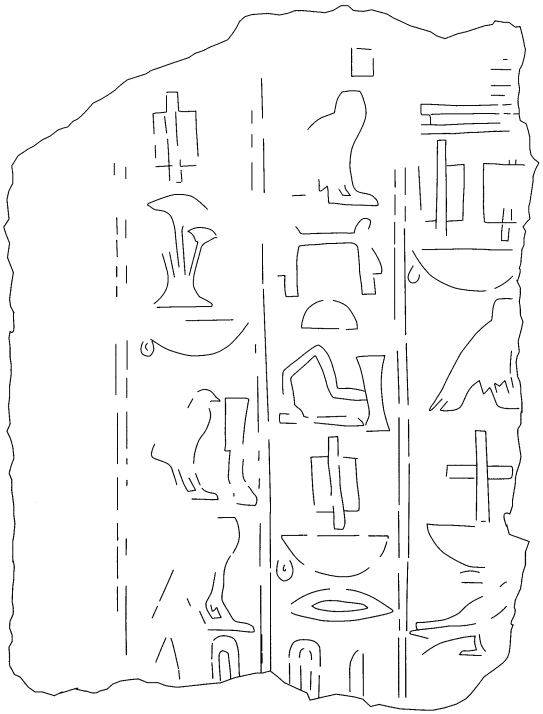

82a. Khnumenti (G 2374), Room I, inscribed block from court of Senedjemib Complex assigned to right (north) inner entrance thickness; after HU-BMFA Exp. Ph. A 6021 [left]

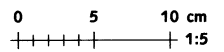
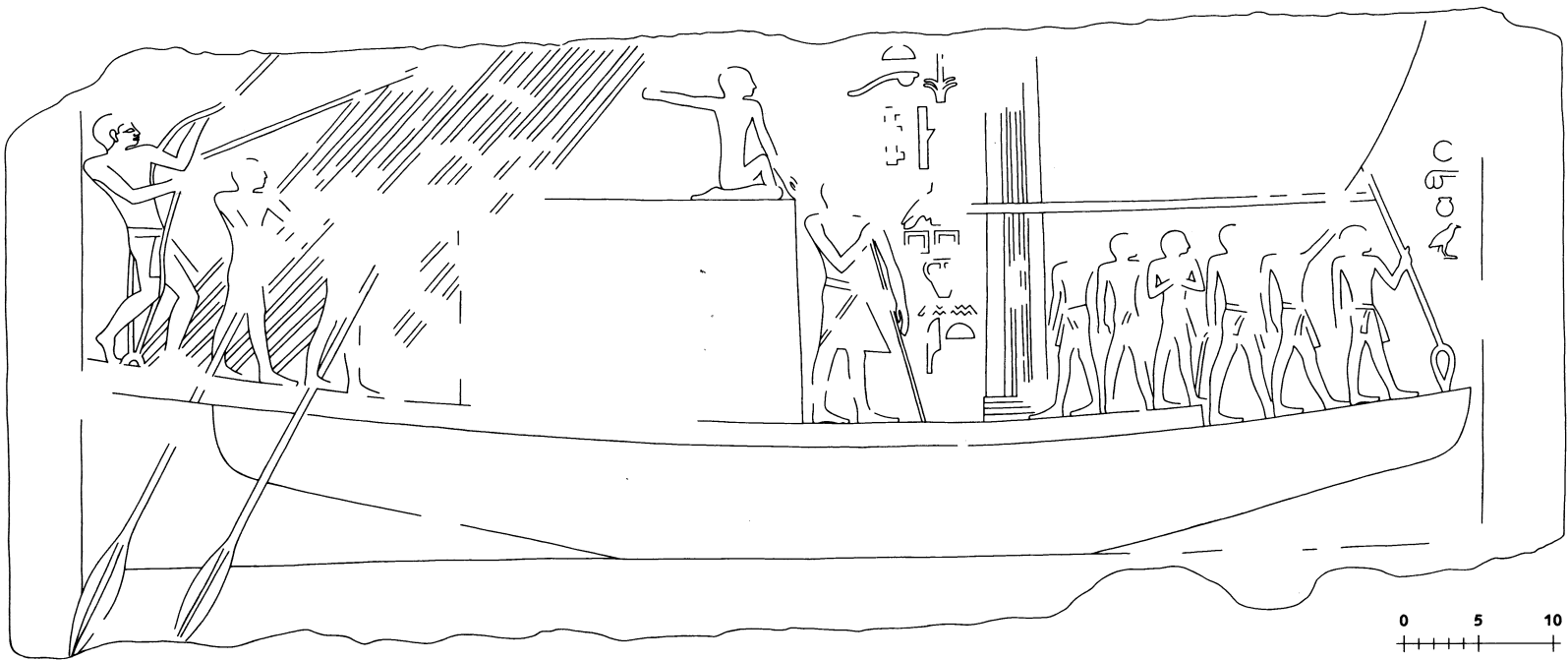

82b. Khnumenti (G 2374), Room I, inner right (north) entrance thickness. EG 4369

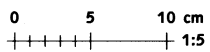
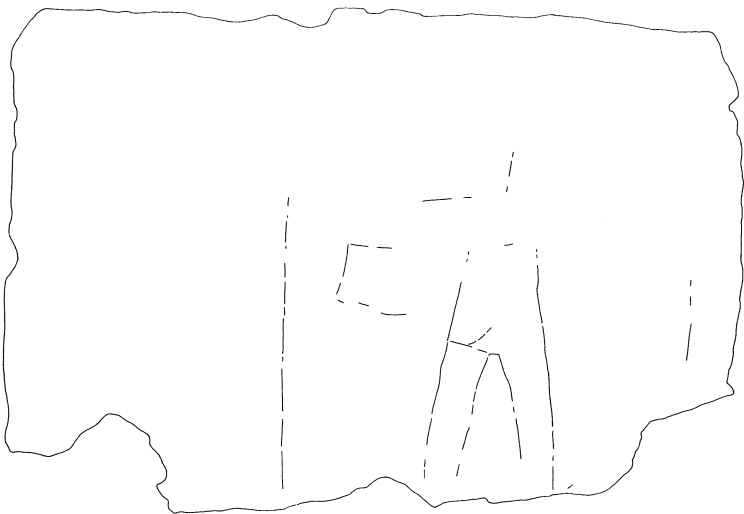

82c. Khnumenti (G 2374), Room I, relief on east wall, south of entrance. EG 4545



83. Khnumenti (G 2374), Room I, south wall. EG 4374

0 5 10 cm
1:5

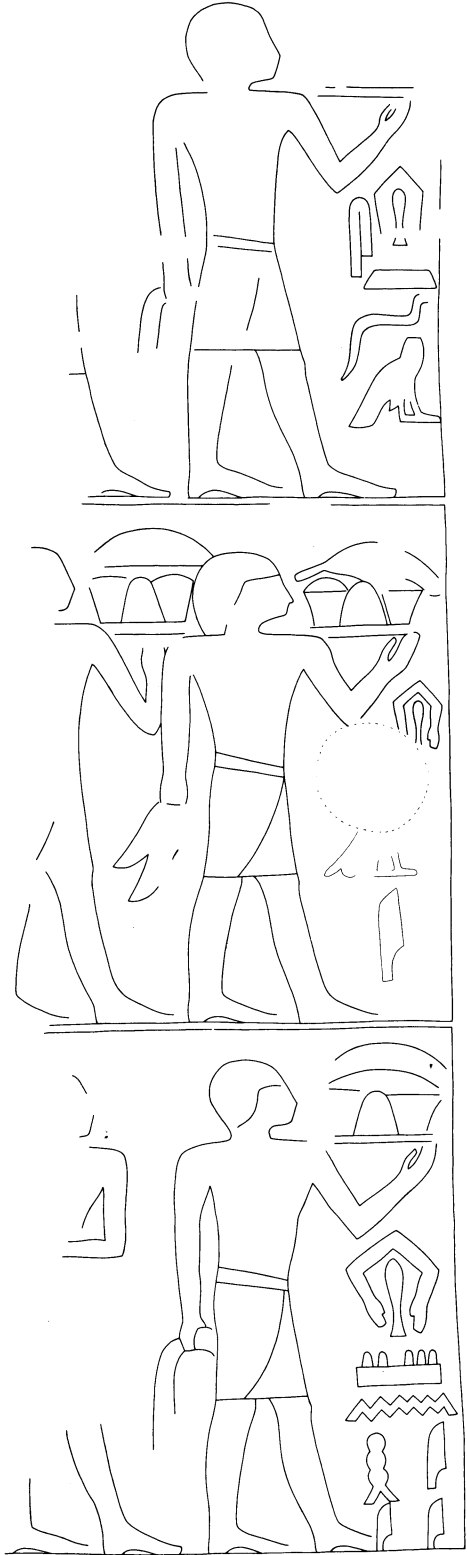

84a. Khnumenti (G 2374), Room I, west wall, south of door. EG 4372, 4546

0 5 10 cm
+++++ 1:5

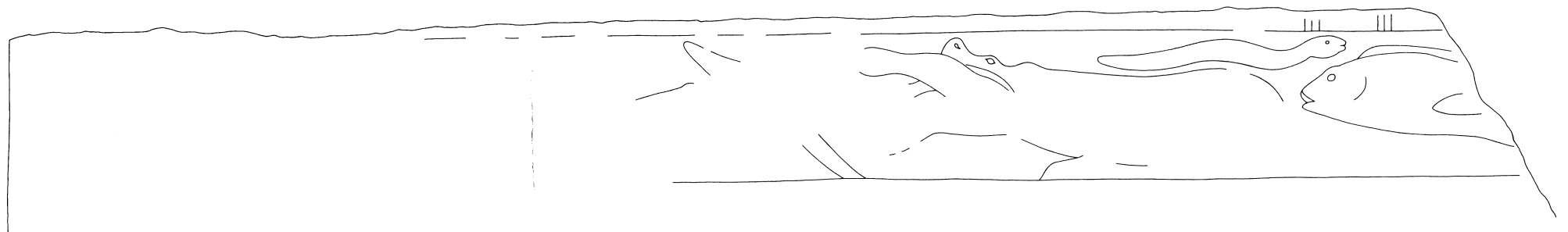

84b. Khnumenti (G 2374), Room I, west wall, north of door. EG 4371

0 5 10 cm
+++++ 1:5

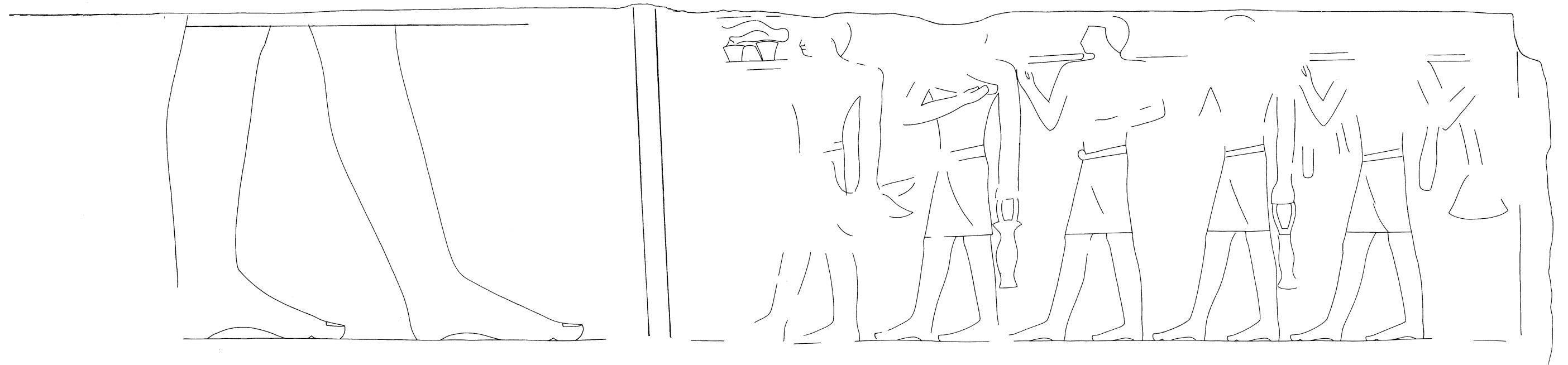

85. Khnumenti (G 2374), Room I, north wall. EG 4369-4370

0 5 10 cm
+++++ 1:5



86. Khnumenti (G 2374), Room I, east wall, north of door

0 5 10 cm
+ + + + + 1:5

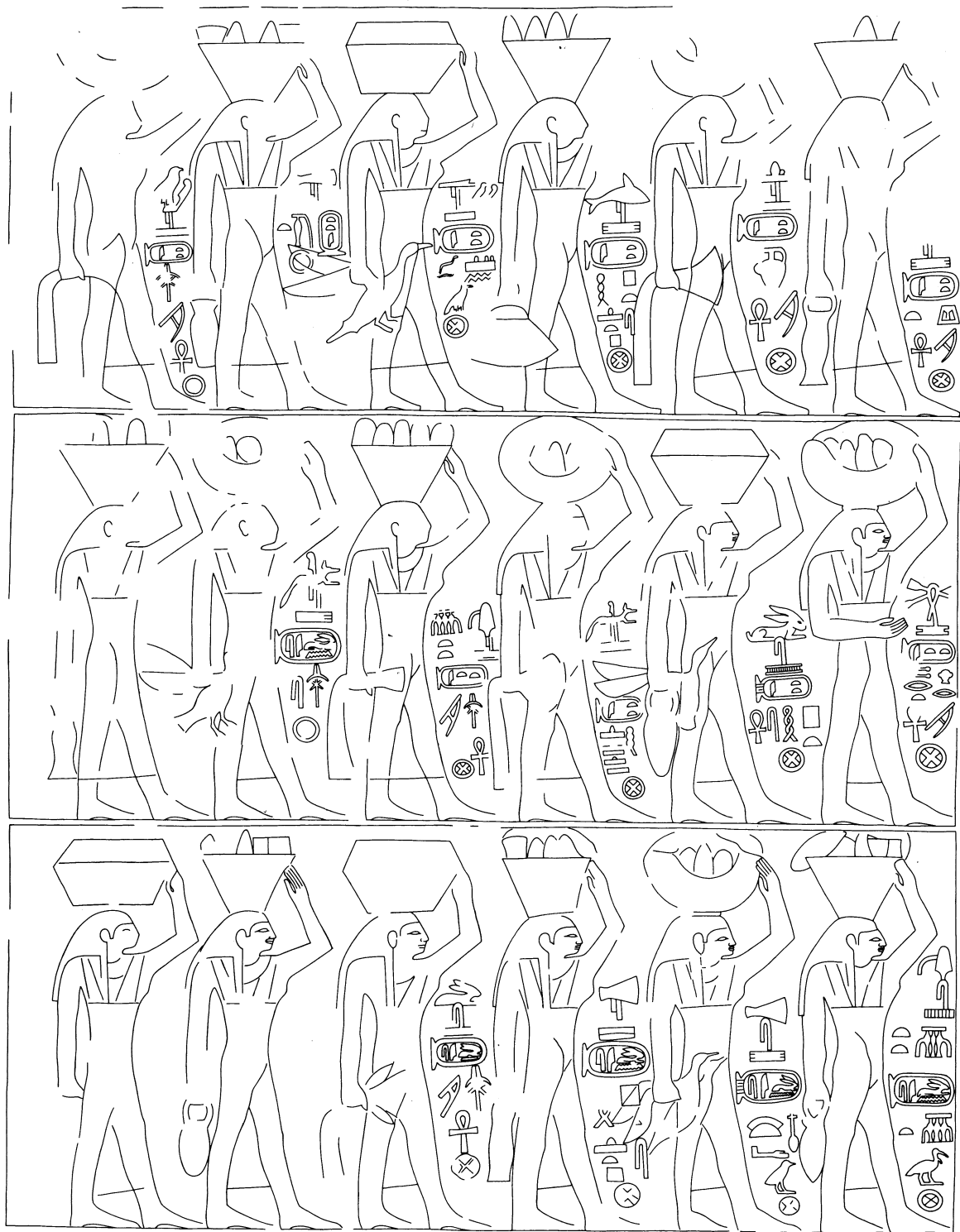

87a. Khnumenti (G 2374), Room II, left (south) entrance thickness. EG 4376.

0 5 10 cm
+++++ 1:5

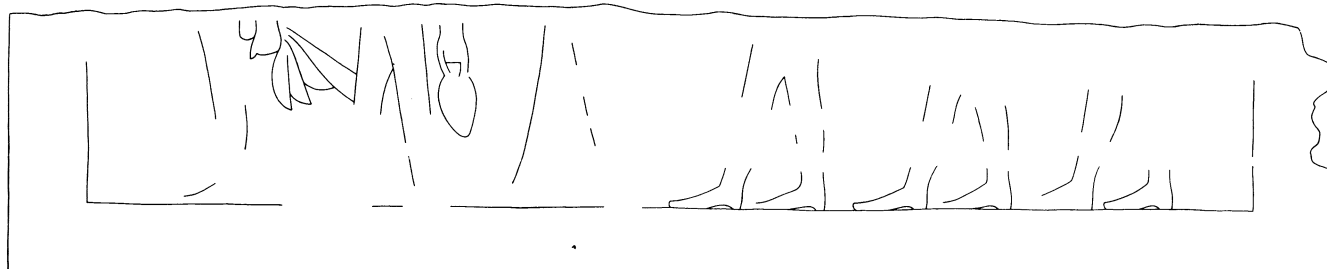

87b. Khnumenti (G 2374), Room II, right (north) entrance thickness. EG 4365

0 5 10 cm
+++++ 1:5

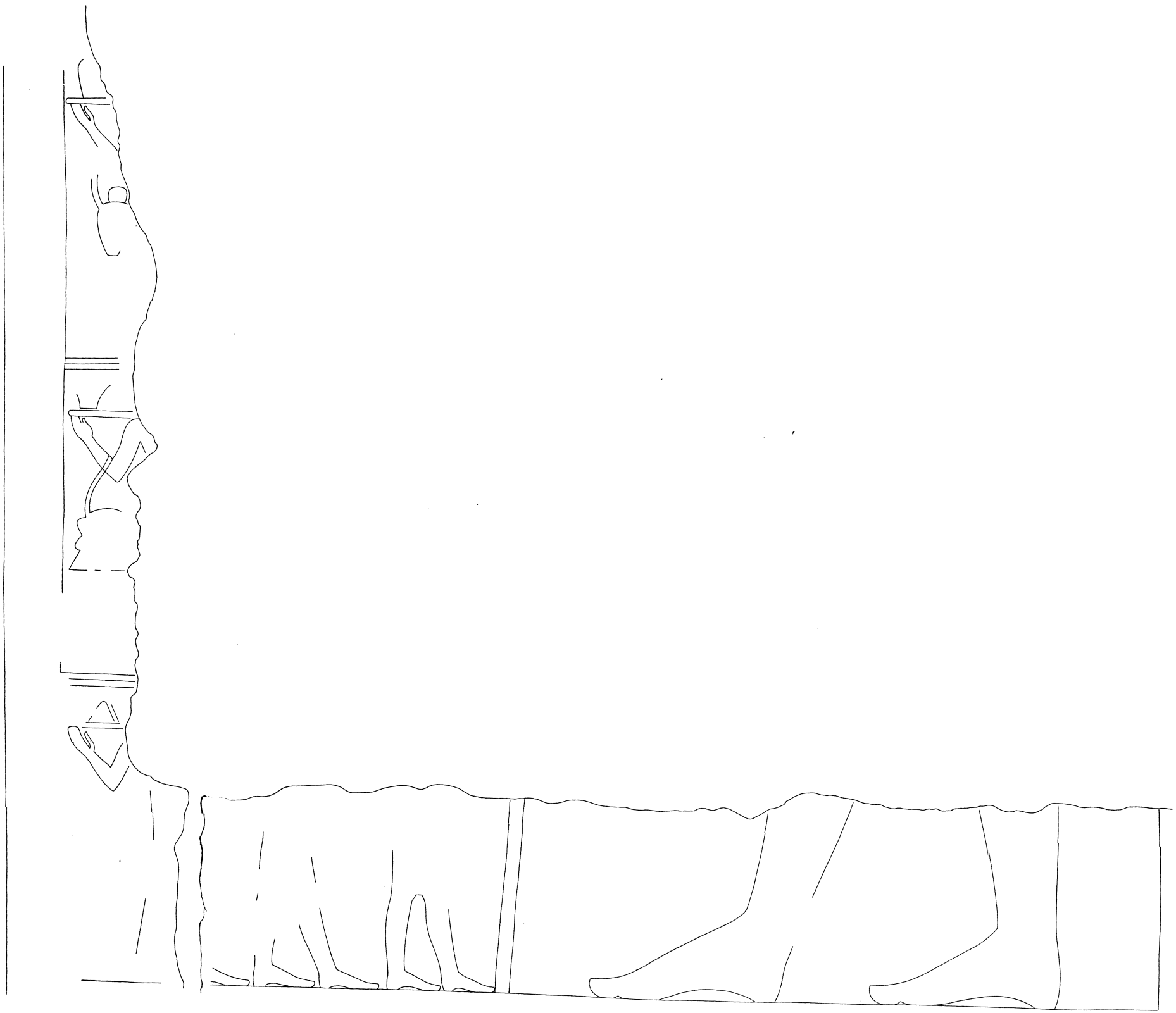

89a. Khnumenti (G 2374), Room II, west wall. EG 4371, 4376

0 5 10 cm
+ + + + + 1:5

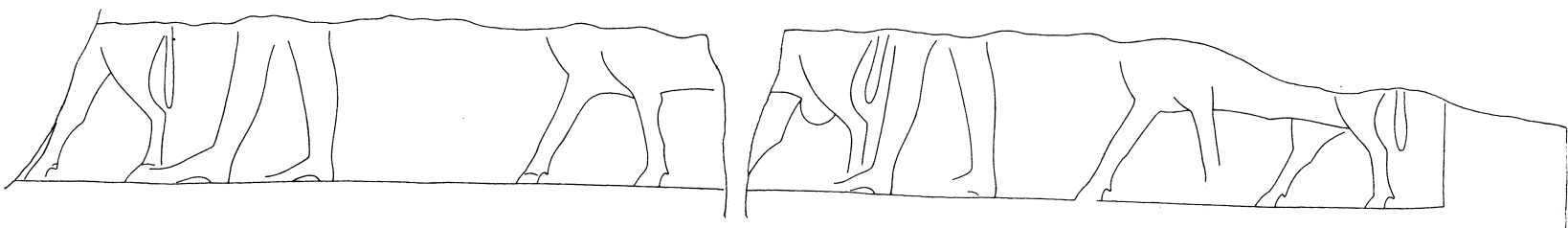

89b. Khnumenti (G 2374), Room II, north wall. EG 4365

0 5 10 cm
+ + + + + 1:5

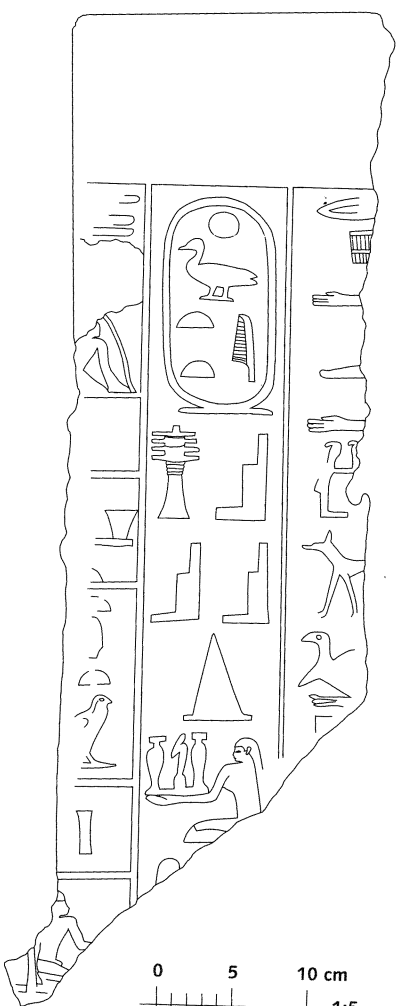

0 5 10 cm
+ + + + + 1:5

89c. Khnumenti (G 2374), Room III, relief assigned to south wall

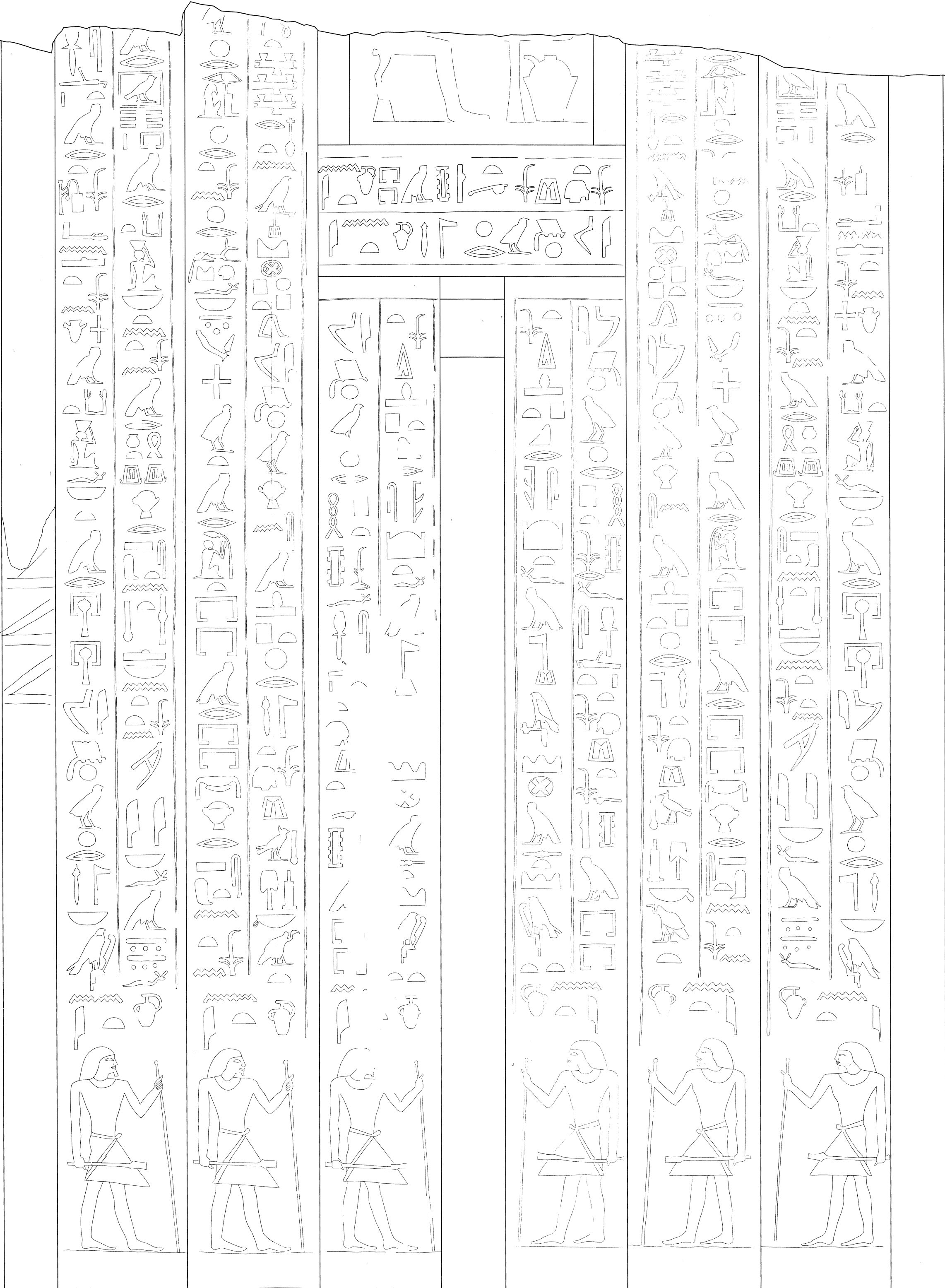

90. Khnumenti (G 2374), Room II, west wall, false door. EG 4538-4541 with additions

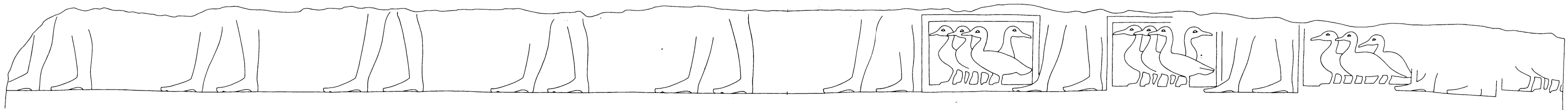

91. Khnumenti (G 2374), Room III, relief assigned to north wall. EG 4379

0 5 10 cm
+++++ 1:5

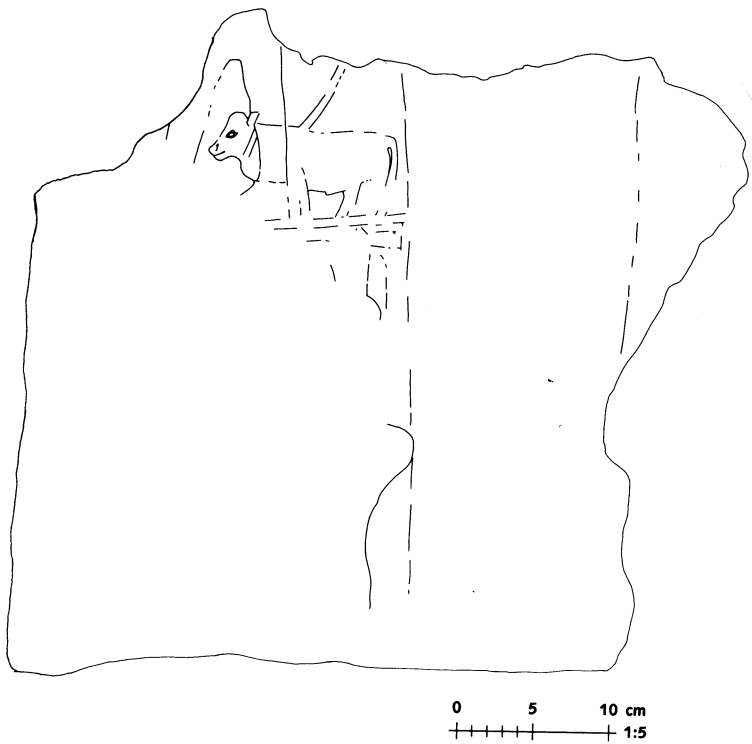

92a. Khnumenti (G 2374), Room III, relief assigned to east wall

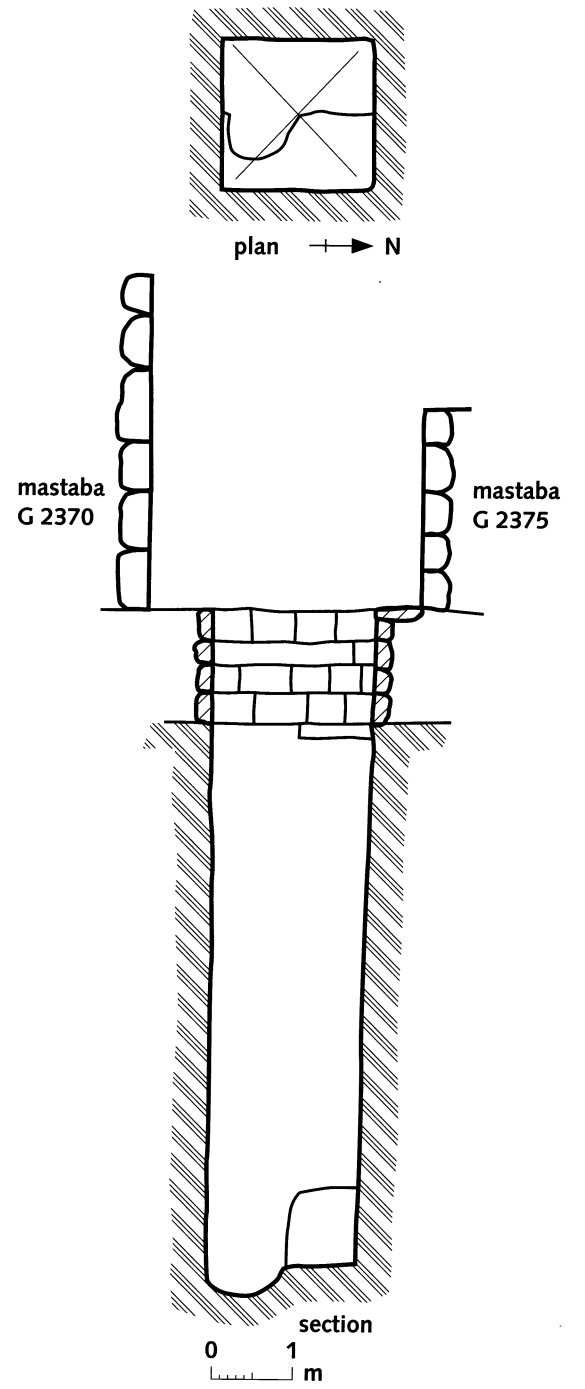

92b. Khnumenti (G 2374), plan and section of G 2374 A

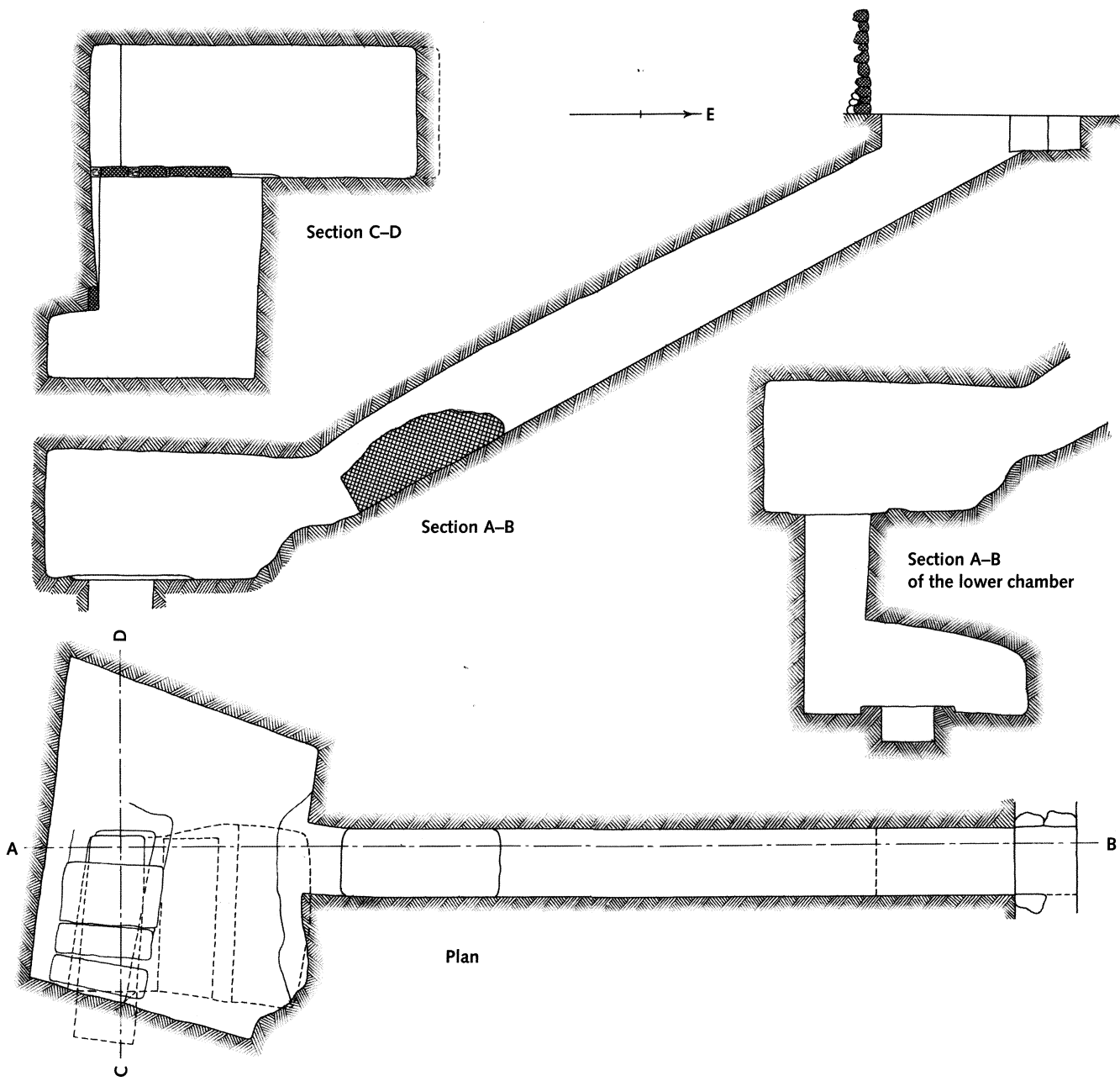

93. Khnumenti (G 2374), plan and sections of G 2385 A

G 2374

G 2385 A

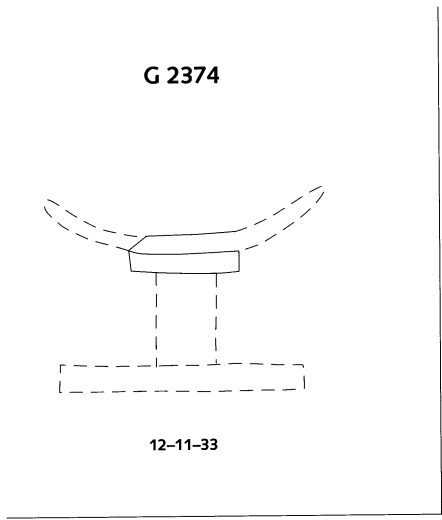

12-11-33

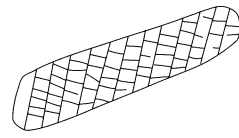

12-12-85



12-12-86

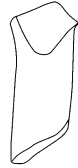
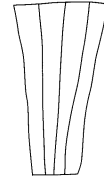

12-12-87



12-12-88

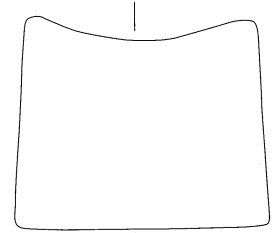

12-12-97

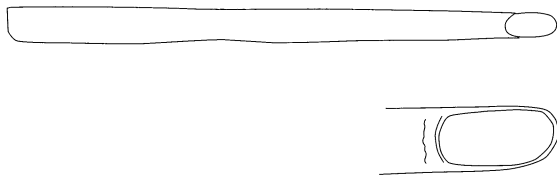

12-12-105

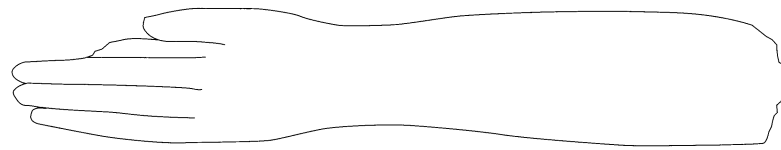

12-12-106

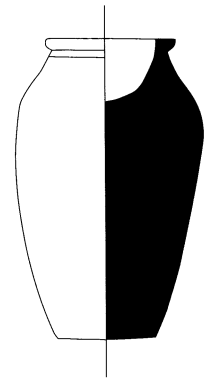

12-12-107

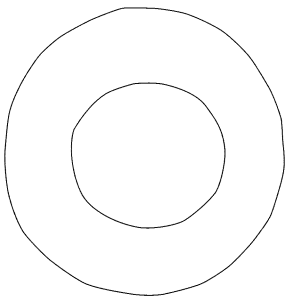

12-12-108

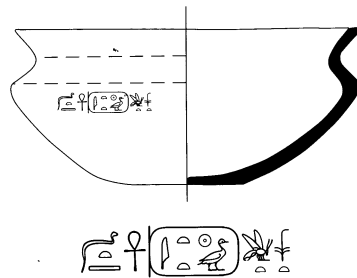

12-12-109

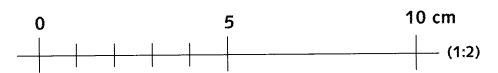

94a. Khnumenti (G 2374), objects from G 2374 and G 2385 A

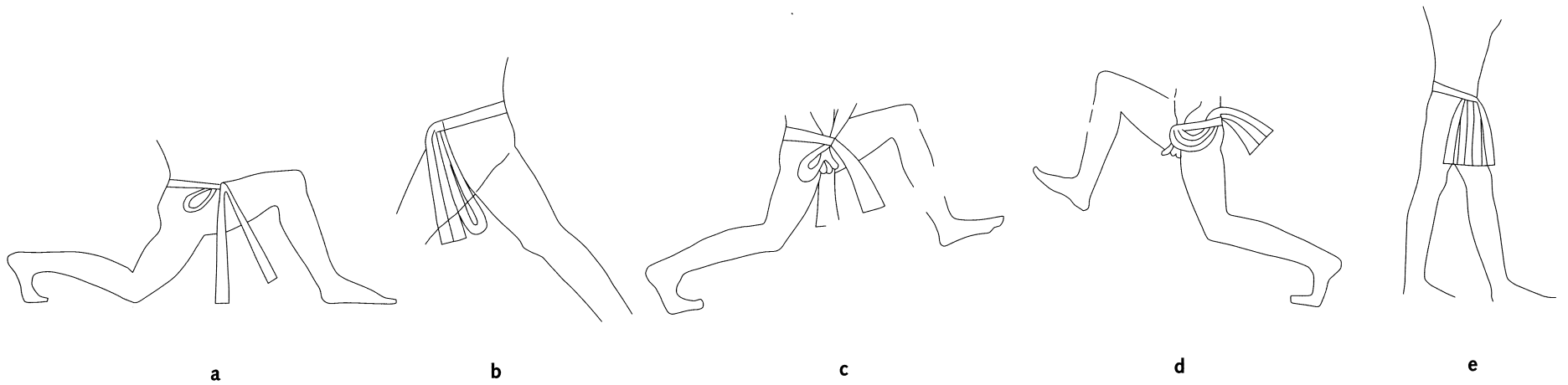

94b. Long belt-sash garments worn by laborers and porters in scenes of daily life

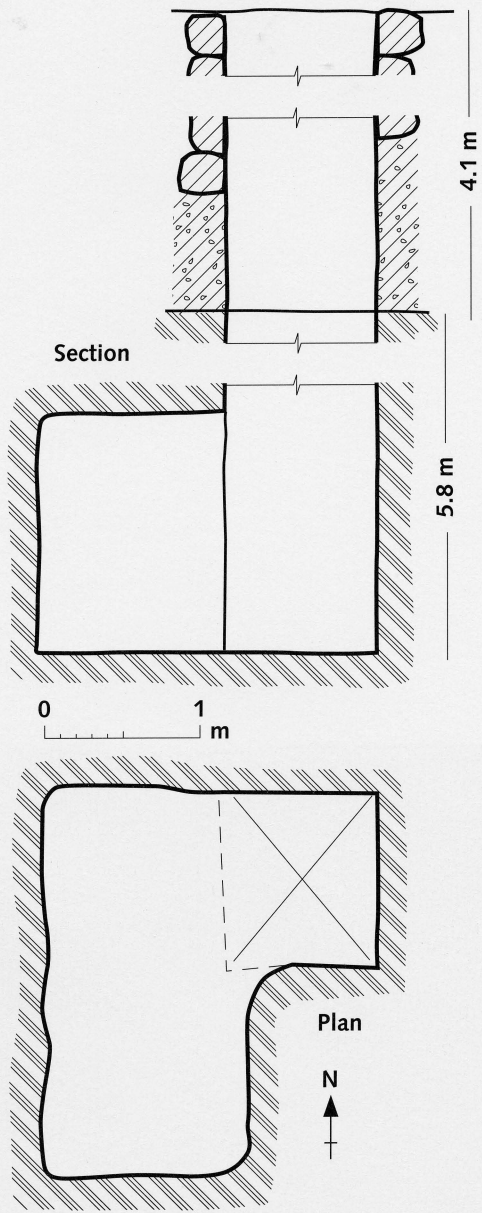

95a. Plan and section of G 2376 A

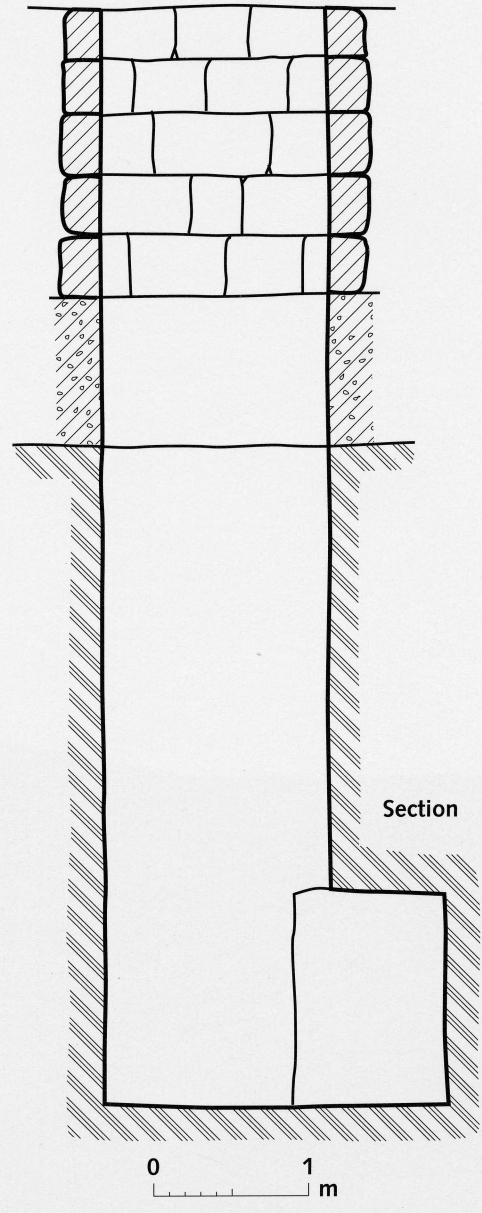

95b. Plan and section of G 2377 A

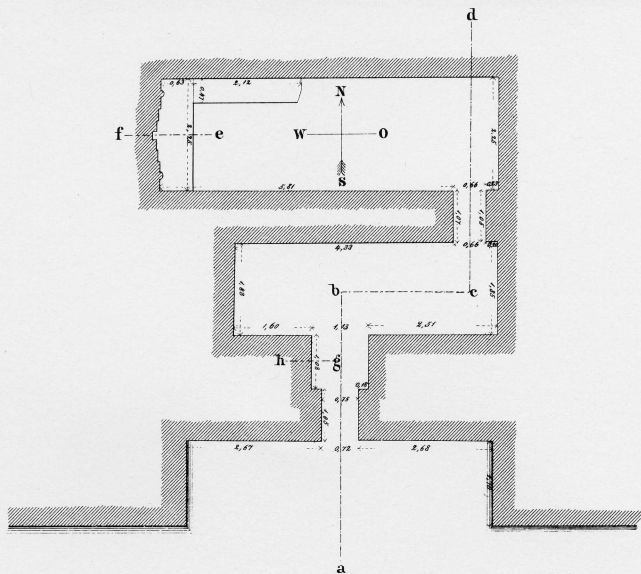

Grundriss.

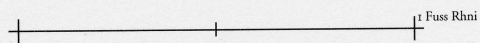
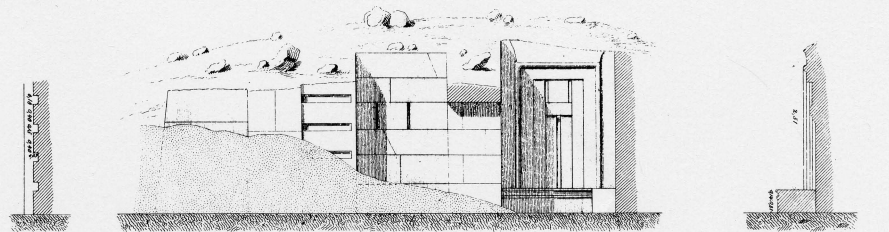

95c. Senedjemib Mehi (G 2378), plan and sections; LD 1, pl. 23 [top]

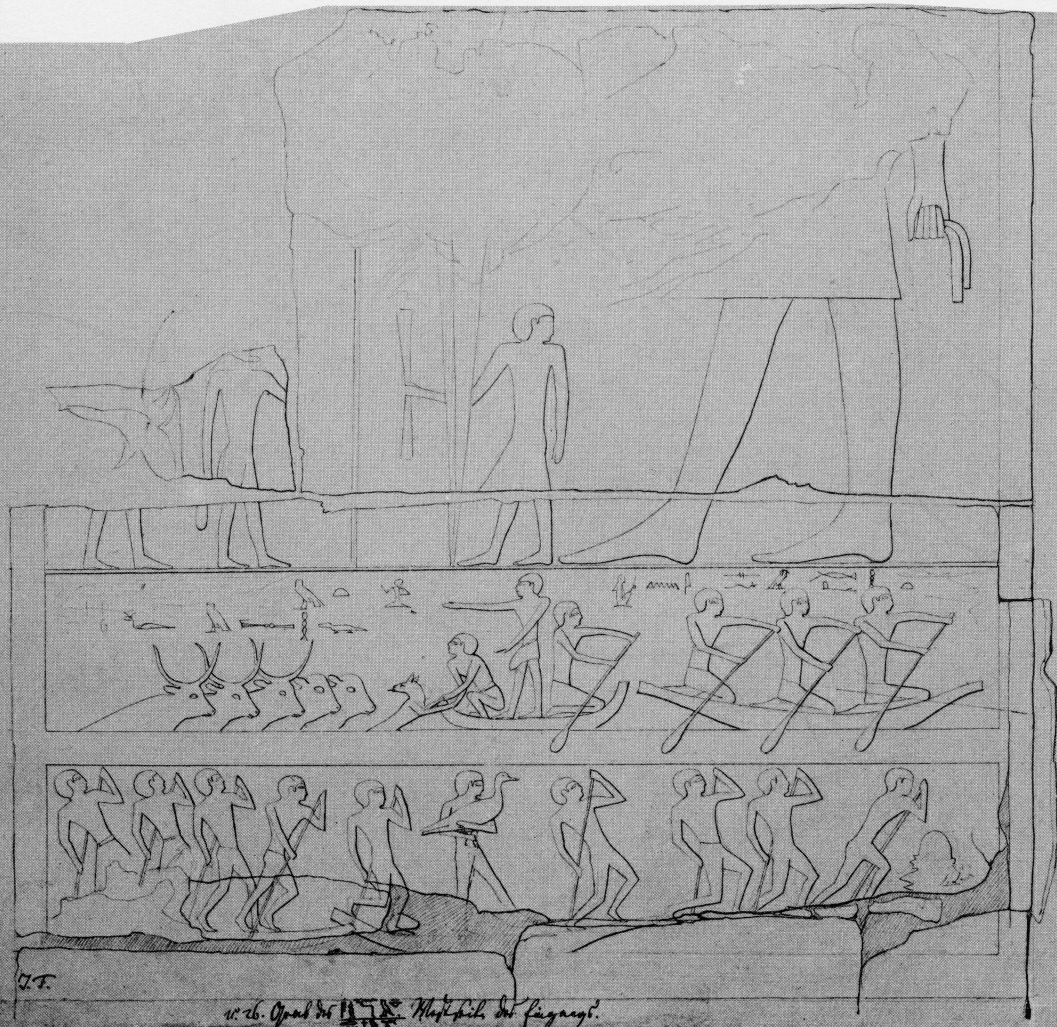

96. Senedjemib Mehi (G 2378), portico, west wall; LD, *Ergänz.*, pl. xii [lower]

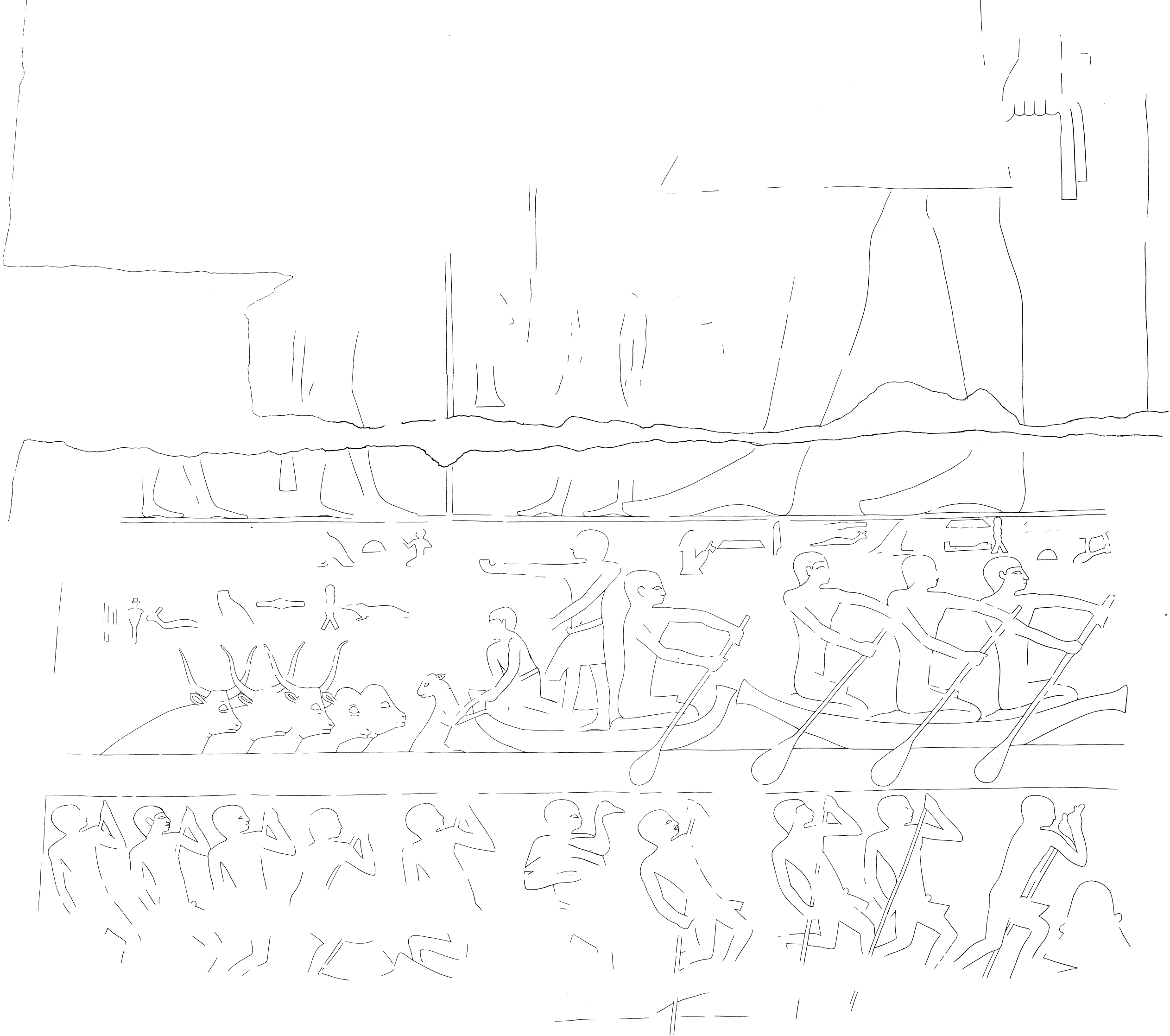

97. Senedjemib Mehi (G 2378), portico, west wall. EG 4478-4480

0 5 10 cm
+++++ 1:5

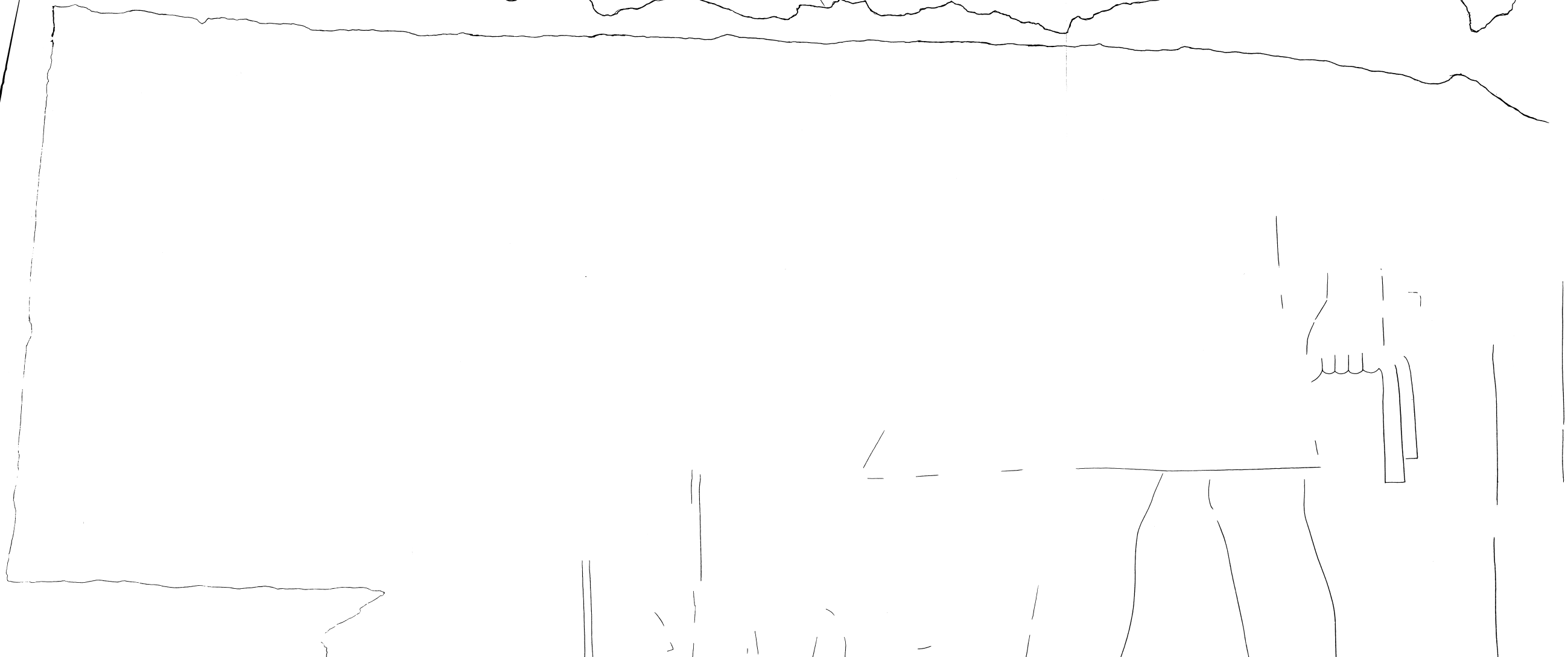
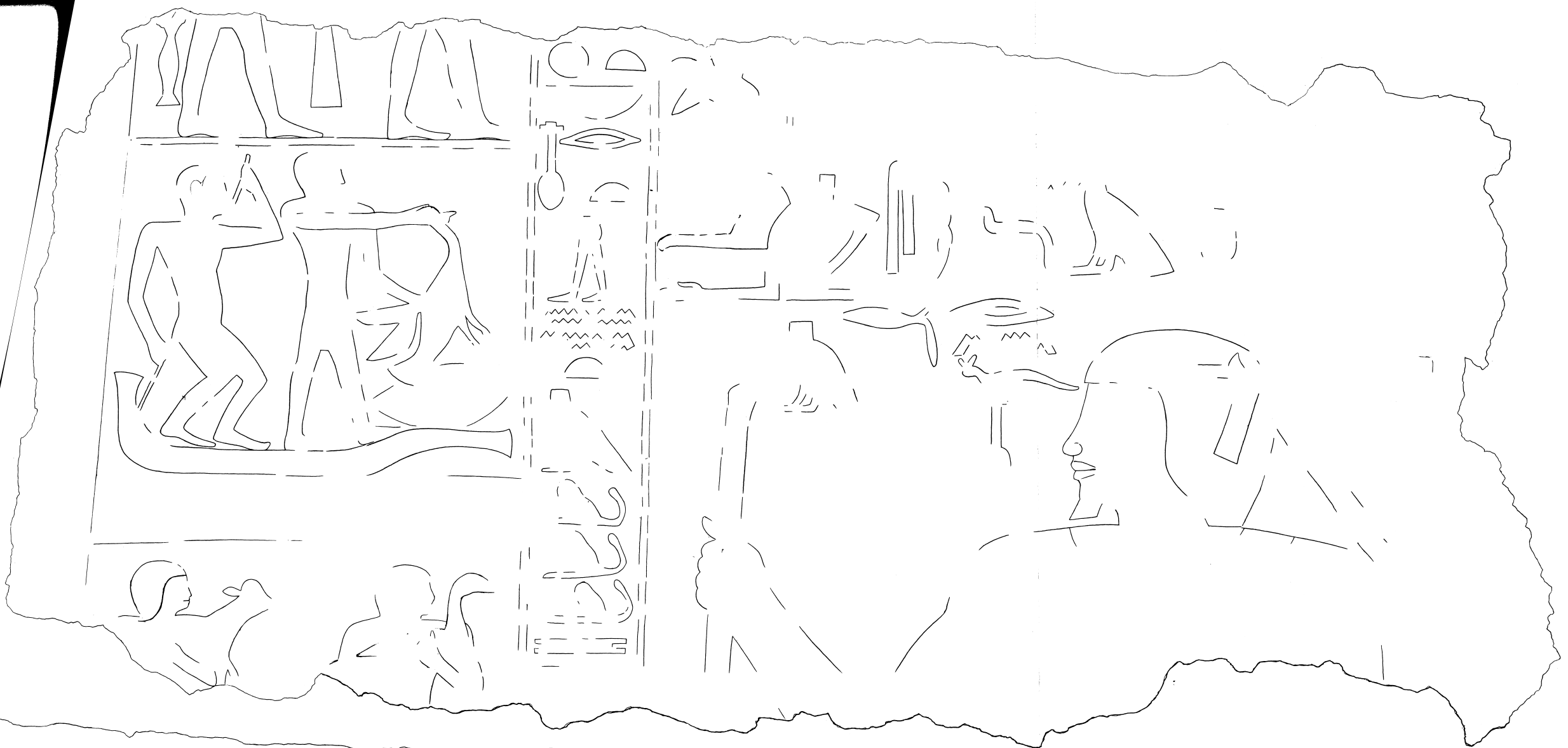

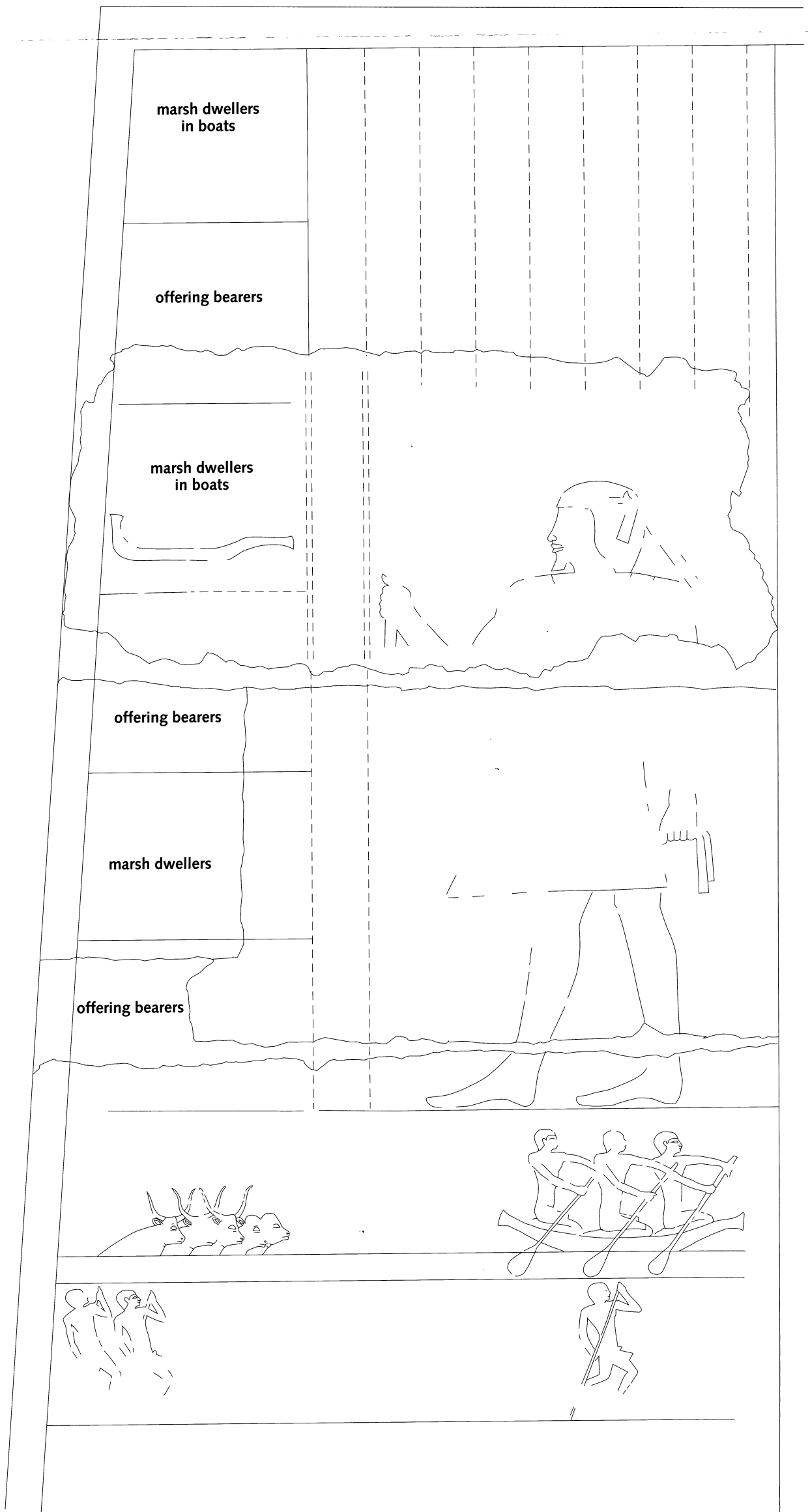

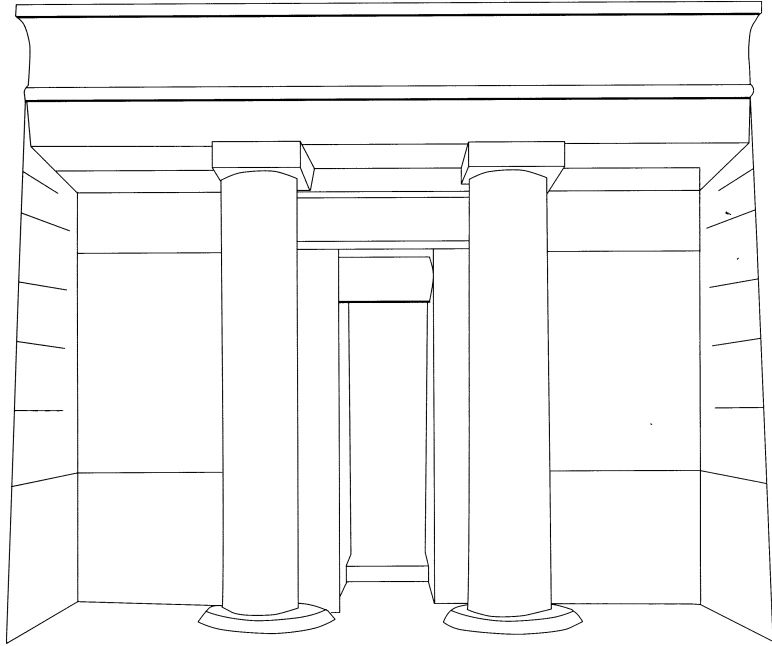

a

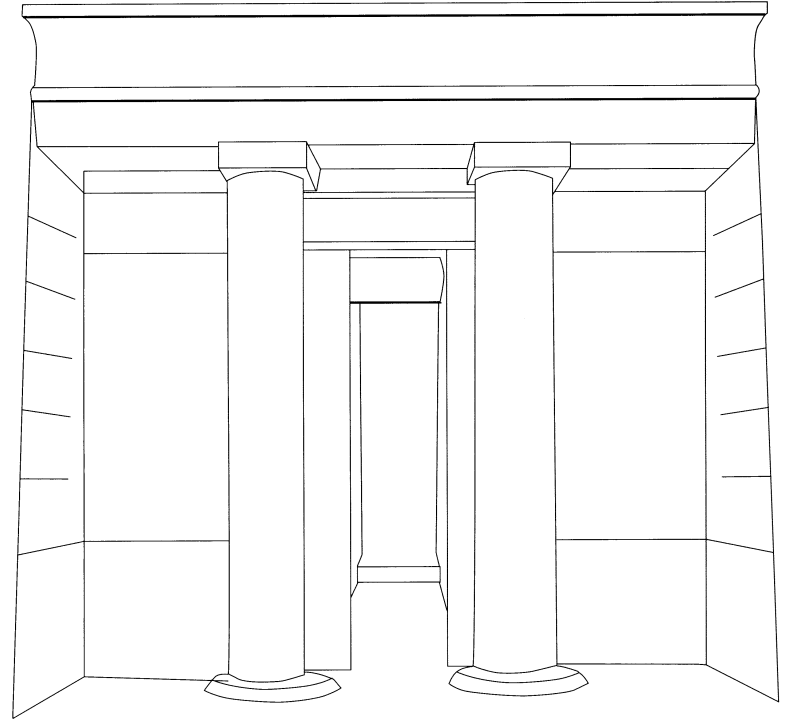

b

99. Reconstructions of front elevations of tombs of Seshemnofer IV (a) and Senedjemib Mehi (c 2378) (b)

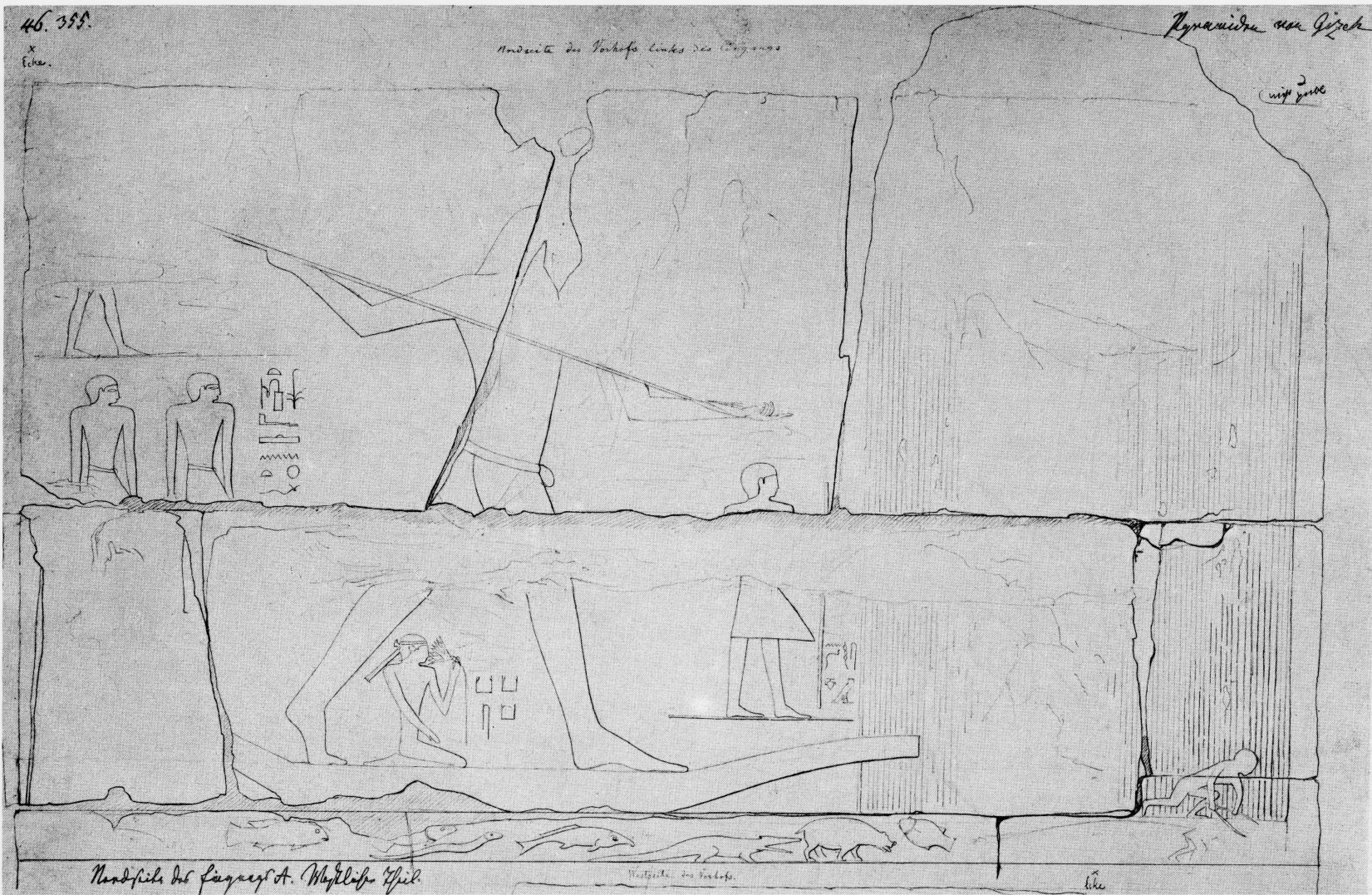

100. Senedjemib Mehi (G 2378), portico, north wall, west of entrance; LD, *Ergänz.*, pl. xii [upper]